

CATÁLOGO DE
PEÇAS ORIGINAIS
FABRIMAR

MAIO 2018

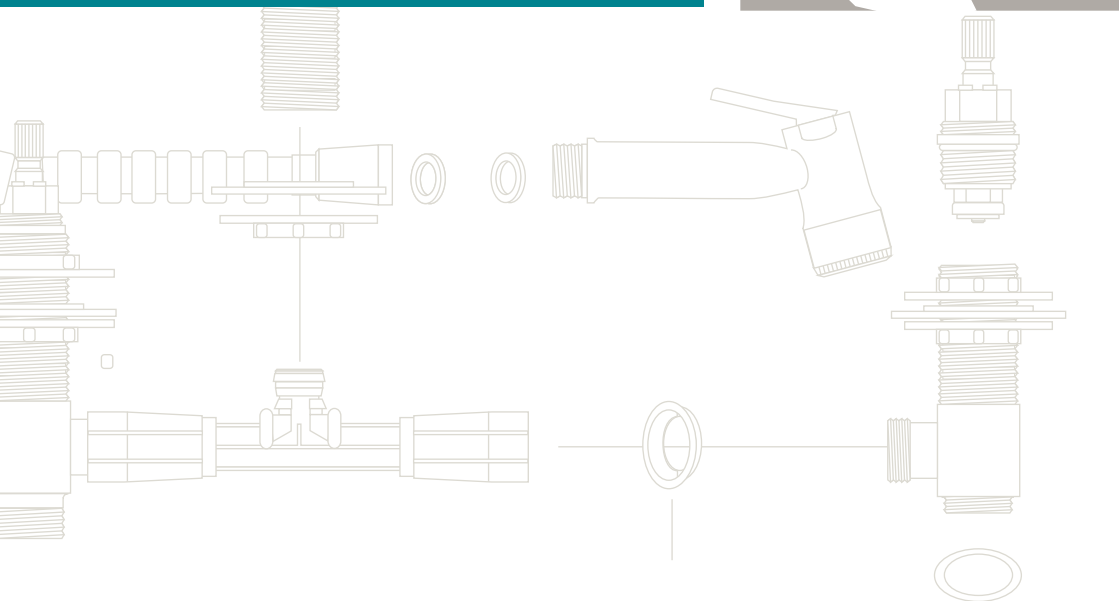

TERMO DE GARANTIA

- Parabéns! Você acabou de adquirir mais um produto com a reconhecida qualidade e alta tecnologia FABRIMAR, demonstrando com essa decisão seu interesse por elevados padrões de qualidade, funcionalidade e segurança.
- Esta garantia cobre os produtos FABRIMAR [metais sanitários] produzidos a partir de maio/98, contra qualquer defeito de material e/ou fabricação dentro de um período de 10 (dez) anos, a contar da data de emissão da nota fiscal de compra, sendo válida somente para produtos adquiridos e instalados em território brasileiro.
- Durante o primeiro ano, a contar da data da compra, fica assegurado ao consumidor a gratuidade de troca de peças e mão-de-obra na Rede de Assistência Técnica FABRIMAR ou nos locais onde houver um técnico credenciado.
- O presente Termo de Garantia terá validade com a apresentação da nota fiscal discriminada, devendo nela constar o código e/ou descrição do produto, sendo a responsabilidade da FABRIMAR restrita apenas às peças e partes de sua fabricação.
- A FABRIMAR se reserva o direito de consertar ou promover a substituição de produtos defeituosos conforme sua melhor conveniência, não autorizando nenhuma pessoa ou entidade a assumir, por sua conta, qualquer outra responsabilidade relativa à garantia de seus produtos além das aqui explicitadas.
- Continuamente comprometida com o aprimoramento tecnológico, a FABRIMAR poderá alterar características gerais, técnicas e estéticas de seus produtos sem aviso prévio, não obstante no entanto os termos desta garantia, conforme a legislação vigente.
- Esta garantia é acessória e complementar conforme disposto no Art. 50 da Lei 8078 de 11/09/90 [Código de Defesa do Consumidor].

10

GARANTIA DE 10 ANOS. FABRIMAR

GUARDE A NOTA FISCAL E ESTE CERTIFICADO DE GARANTIA

A GARANTIA NÃO COBRE

- Prejuízos causados ao produto em virtude de: acidentes, quedas, maus tratos ou abusos, manuseio inadequado, perdas de partes, erros de especificação e instalação incorreta, falhas no funcionamento do produto decorrentes de problemas no abastecimento hidráulico;
- Danos causados em decorrência de aplicação de produtos em instalações elétricas e/ou hidráulicas que não estejam em conformidade com as normas técnicas brasileiras vigentes, ou na inexistência destas, em desacordo com as recomendações da FABRIMAR.
- Danos aos acabamentos em consequência do uso de materiais inadequados para limpeza como: produtos químicos, solventes, pastas, abrasivos [saponáceo, palha de aço, esponja dupla face, lixas];
- Despesas com instalação ou remoção e transporte do produto para reparo ou substituição;
- Despesas decorrentes e consequentes de instalação de peças que não pertençam ao produto;
- Peças sujeitas a desgaste normal, tais como pilhas, vedantes, gaxetas, guarnições, gavetas, anéis de vedação e mecanismos de vedação;
- Produtos, peças ou partes que tenham sido reparadas por pessoas não autorizadas pela FABRIMAR;
- Produtos instalados em locais onde a água é considerada não tratada para condições de consumo ou que contenha impurezas e substâncias ou objetos estranhos a mesma, que ocasione o mal funcionamento do produto;
- Produtos com adaptação de peças adicionais sem autorização prévia do fabricante, aplicação de peças não originais ou inadequadas;
- Vidros e acrílicos em geral;
- Produtos instalados em locais submetidos a altas temperaturas e/ou ambientes com atmosfera agressiva.

REDUÇÃO DE GARANTIA

- Produtos Fabrimar instalados para uso público terão período total de cobertura reduzido para 5 (cinco) anos e a gratuidade de troca de peças e mão-de-obra assegurada por um período de 6 (seis) meses, a contar da data de compra.

FABRIMAR

Fabrimar Metais Sanitários
Rod. Presidente Dutra - 1362
Pavuna - Rio de Janeiro - RJ - Cep:21535-502
www.fabrimar.com.br



**SERVIÇO DE
ATENDIMENTO
AO CONSUMIDOR
0800 022-1362**

51100364

ACABAMENTOS

Grupo 1

REGISTROS

Grupo 2

MISTURADORES

Grupo 3

TORNEIRAS

Grupo 4

CHUVEIROS

Grupo 5

DUCHAS

Grupo 6

VÁLVULAS DE DESCARGA

Grupo 7

ELETRÔNICOS

Grupo 8

AUTOMÁTICOS

Grupo 9

COMPLEMENTOS

Grupo 10

ACESSÓRIOS

Grupo 11

POSIÇÃO DOS REGISTROS

Página 1.01

ACABAMENTOS PARA OS REGISTROS

Página 1.02

SOLUÇÕES ESPECIAIS - POSIÇÃO SALIENTE

Página 1.21

SOLUÇÕES ESPECIAIS - POSIÇÃO ENTERRADO

Página 1.35

SOLUÇÕES ESPECIAIS - CONVERSORES

Página 1.45



Aquarius



Ascot



Chiara



Civic



Creato



Digital Line



Duello



Folk



Gyro



Goa



Gyro



Junior



Loft



Loft Design



Lyon



Misty



Oggi



Petra



Shiva



Soho



Vitra



Zeta

Acabamentos
Fora de Linha
após 2011



Adagio



Caprice



Classic



Image



Domani



Eixo



Innovare



Jolie



Levier



Lucca



Orion



Saga



Saga Cross



Sirius



Squadra



Trezzo



Vesper



Simetria

Acabamentos
Fora de Linha
Antigos



Cosmos



Firenze



Nobile



Spazio



Vega



Vesper

Registro em Posição Normal

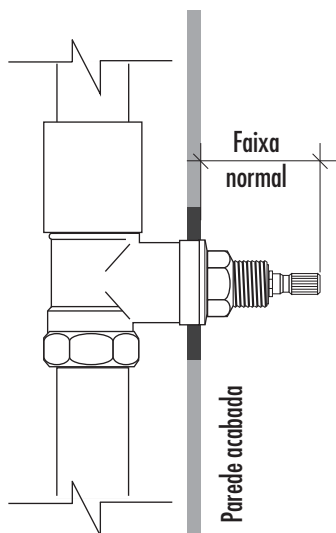

Bitola do Registro	Faixa Normal		Acabamento
	mín	máx	
Pressão 1/2"	37 mm	47 mm	A1
Pressão 3/4"	37 mm	47 mm	A1
Pressão 1"	37 mm	47 mm	A1
Gaveta 1/2"	37 mm	47 mm	A1
Gaveta 3/4"	37 mm	47 mm	A1
Gaveta 1"	47 mm	57 mm	A2
Gaveta 1 1/2"	61 mm	71 mm	A3
Gaveta 1 1/4"	61 mm	71 mm	A3

Registro em Posição Saliente

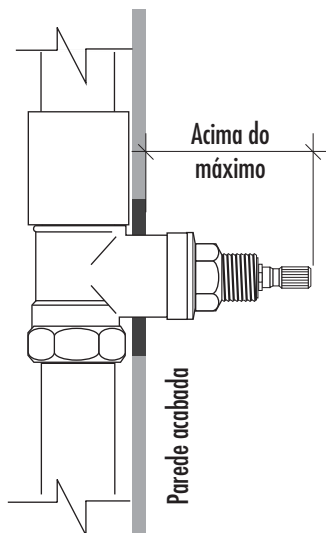

Registro em Posição Enterrada

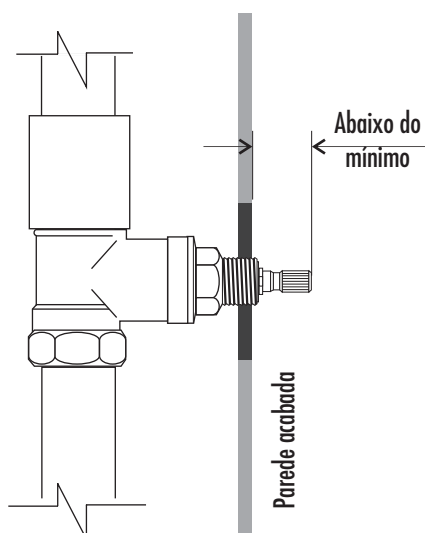

Componentes do acabamento: (exceto linhas Innovare e Saga que não possuem reparo)

ACABAMENTO A1 (para instalação em registros de pressão de 1/2", 3/4" e 1" e registros de gaveta 1/2" e 3/4"):

- volante
- prensa canopla
- canopla
- friso água quente e fria (opcional)

ACABAMENTO A2 (para instalação em registros de gaveta de 1"):

- volante
- prensa canopla
- canopla
- friso água quente e fria (opcional)
- saia

Observações.:

1- Os volantes não são vendidos separadamente, somente como parte integrante do acabamento.

2- Os acabamentos das linhas Folk, Zeta, Shiva e Vitra não utilizam as soluções "friso água quente e fria" e "saia".



Aquarius

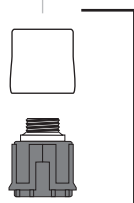

PRENSA CANOPLA
AQUARIUS
CR - CPD.01639



CANOPLA T1/T2
CR - CPD.04075



FRISO CANOPLA
CPD.00847
(ver página 1.12)



SAIA T2
CR - CPD.05249



Misty

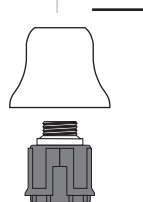

PRENSA CANOPLA
MISTY
CR - CPD.03152

 FORA DE LINHA



CANOPLA MISTY
CR - CPD.03146

 FORA DE LINHA



FRISO CANOPLA OGGI
CPD.02888
(ver página 1.12)



SAIA T2
CR - CPD.05249

Canopla e Prensa modificados em maio /2016
Página 1.06

Atualmente utiliza sistema Fabrieasy
Página 1.05



Eixo



Gyro



Soho



Squadra



PRENSA CANOPLA SOHO
CR - CPD.04282

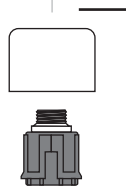

PRENSA CANOPLA SQUADRA
CR - CPD.00180

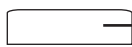

CANOPLA SOHO
CR - CPD.04280



CANOPLA SQUADRA
CR - CPD.03838



FRISO CANOPLA OGGI
CPD.02888
(ver página 1.12)



FRISO CANOPLA IMAGE
CPD.04080
(ver página 1.12)



SAIA T2
CR - CPD.05249



SAIA T2
CR - CPD.05249



Folk



Vitra



PRENSA CANOPLA
SOHO
CR - CPD.04282

CANOPLA FOLK
CR - CPD.06415



FORA DE LINHA

CANOPLA T2 VITRA
CR - CPD.06112



FORA DE LINHA

OBS: Para Registro de Gaveta 1"

SISTEMA FABRIEASY

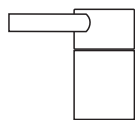

Chiara

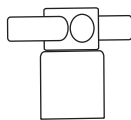

Soho

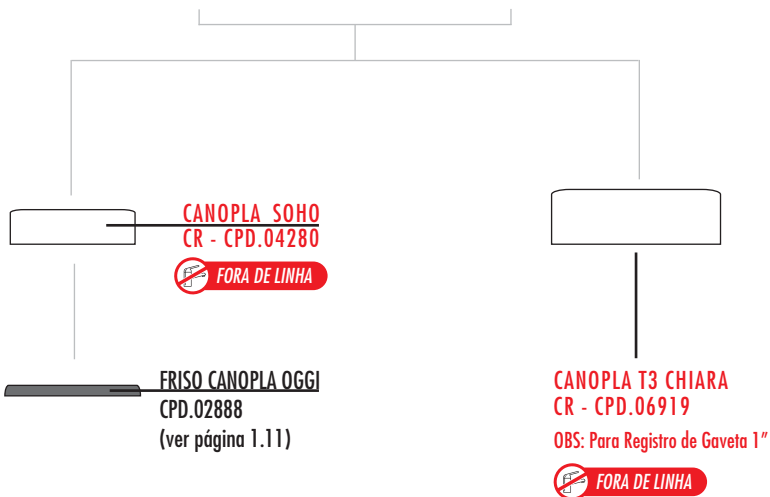

FRISO CANOPLA OGGI
CPD.02888
(ver página 1.11)

CANOPLA SOHO
CR - CPD.04280



CANOPLA T3 CHIARA
CR - CPD.06919

OBS: Para Registro de Gaveta 1"

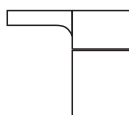

Creato

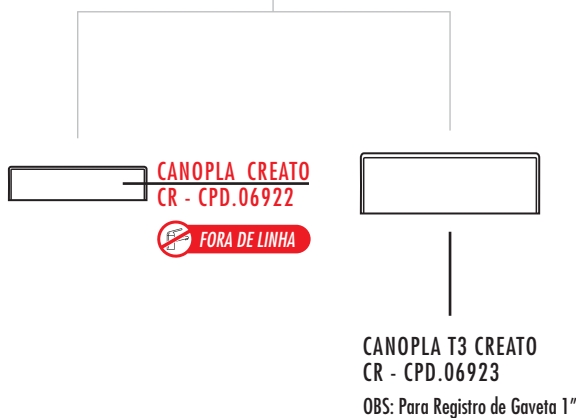

CANOPLA CREATO
CR - CPD.06922



CANOPLA T3 CREATO
CR - CPD.06923

OBS: Para Registro de Gaveta 1"

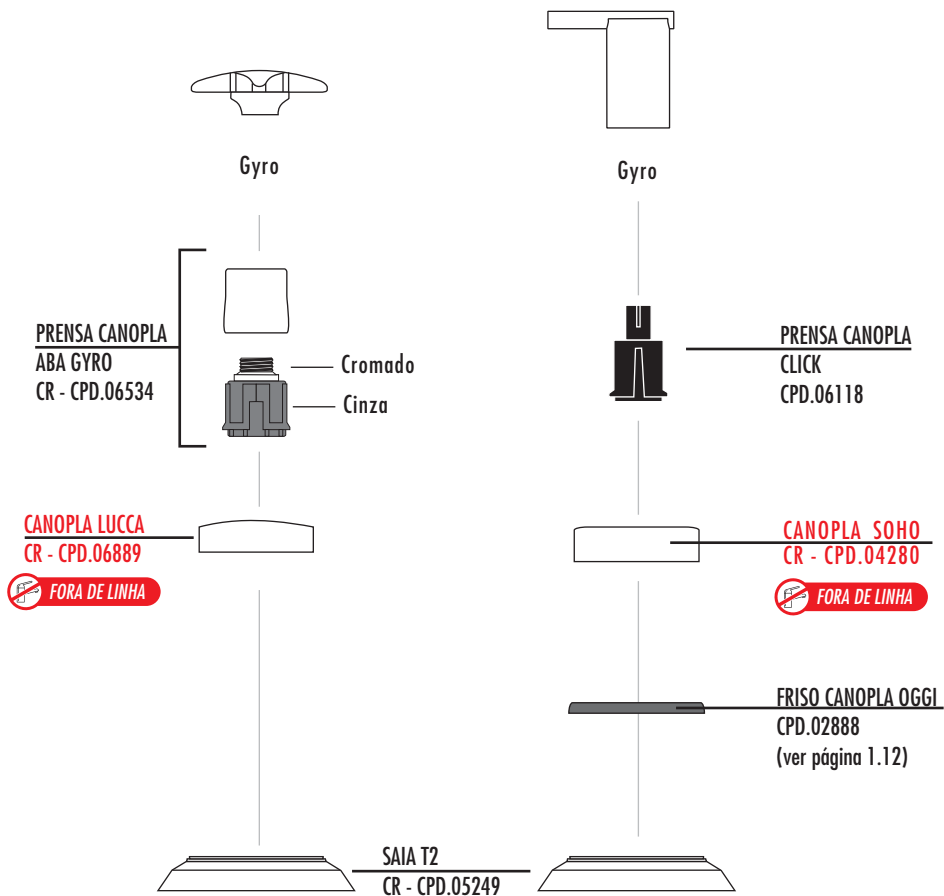



Junior



FRISO CANOPLA OGGI
CPD.02888
(ver página 1.12)

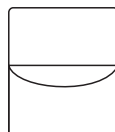

Goa



PRENSA CANOPLA
CLICK
CPD.06118



CANOPLA CREATO
CR - CPD.06922

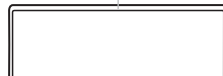

CANOPLA T3 CREATO
CR - CPD.06923

OBS: Para Registro de Gaveta 1"

O prensa canopla e a canopla do volante Júnior não são vendidos separadamente, somente como parte integrante do acabamento.



Ascot



PRENSA CANOPLA
ABA
CPD.03256

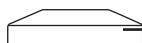

CANOPLA ASCOT
CR - CPD.03145



FORA DE LINHA



FRISO CANOPLA OGGI
CPD.02888
(ver página 1.12)



SAIA T2
CR - CPD.05249



Domani



Duello



Lyon



Oggi



PRENSA CANOPLA
ABA
CPD.03256

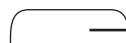

CANOPLA OGGI
CR - CPD.02578



FRISO CANOPLA OGGI
CPD.02888
(ver página 1.12)



SAIA T2
CR - CPD.05249



Image



PRENSA CANOPLA
ABA
CPD.03256



CANOPLA IMAGE
CR - CPD.04008



FRISO CANOPLA IMAGE
CPD.04080
(ver página 1.12)



SAIA T2
CR - CPD.05249



Adagio



Caprice



Digital Line



Jolie



Orion



Petra



Trezzo



PRENSA CANOPLA
ABA
CPD.03256



CANOPLA T1/T2
CR - CPD.04075



FRISO CANOPLA
CPD.00847
(ver página 1.12)



SAIA T2
CR - CPD.05249



Sirius



Vesper

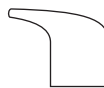

Civic



PRENSA CANOPLA
ABA
CPD.03256



PRENSA CANOPLA
MECANISMO CERÂMICO
CPD.02108

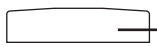

CANOPLA SIRIUS
BR - CPD.00464



CANOPLA OGGI
CR - CPD.02578



FRISO CANOPLA
CPD.00847
(ver página 1.12)



FRISO CANOPLA OGGI
CPD.02888
(ver página 1.12)

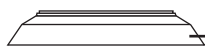

SAIA T2
BR - CPD.00468



SAIA T2
CR - CPD.05249

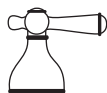

Levier



PRENSA CANOPLA
MECANISMO CERÂMICO
CPD.02108



CANOPLA T1/T2
CR - CPD.04075



FRISO CANOPLA
CPD.00847
(ver página 1.12)



SAIA T2
CR - CPD.05249

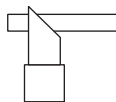

Loft

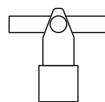

Loft Design



PRENSA CANOPLA
MECANISMO CERÂMICO
CPD.02108



CANOPLA SQUADRA
CR - CPD.03838



FORA DE LINHA



FRISO CANOPLA IMAGE
CPD.04080
(ver página 1.12)



FORA DE LINHA



SAIA T2
CR - CPD.05249



Innovare



Innovare Classic



Saga



Saga Cross

SAIA T2
CR - CPD.05249

Detalhamento dos Reparos

FRISO AZUL (indicador de água fria) / VERMELHO (indicador de água quente)	
 Vermelho - 6 unidades	 Azuis - 6 unidades
FRISO CANOPLA	CPD 00847
Adagio, Aquarius, Caprice, Digital Line, Jolie, Levier, Orion, Sirius, Trezzo e Vesper.	
FRISO CANOPLA OGGI	CPD 02888
Ascot, Civic, Domani, Duello, Eixo, Gioia, Gyro, Junior, Lyon, Misty, Oggi e Soho.	
FRISO CANOPLA IMAGE	CPD 04080
Image, Loft, Loft Design e Squadra.	



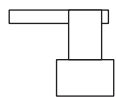

Shiva



Vitra



PRENSA CANOPLA
CLICK
CPD.06118

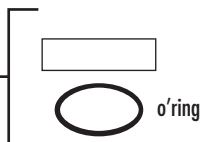

CANOPLA VITRA
CR - CPD.06111



CANOPLA T2 VITRA
CR - CPD.06112

OBS: Para Registro de Gaveta 1"





Adagio



Ascot



Caprice



Digital Line



Domani



Duello



Image



Jolie



Levier



Lyon



Oggi



Orion



Aquarius



Eixo



Gyro



Misty

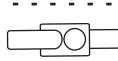

Soho



Petra



Sirius



Squadra



Trezzo



Vesper P

Atualmente utiliza sistema Fabrieasy
Página 1.17

PRENSA CANOPLA
SOHO T3
CR - CPD. 06175

FORA DE LINHA

cubo cromado

PRENSA CANOPLA T3
CPD.03834

CANOPLA T3
CR - CPD.08466



Folk

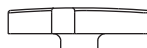

Vitra

**PRENSA CANOPLA
SOHO T3
CR - CPD. 06175**

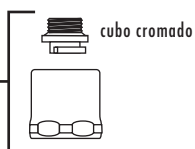

cubo cromado

**CANOPLA T3 VITRA
CR - CPD.06113**



SISTEMA FABRIEASY



CANOPLA T3 CHIARA
CR - CPD.06919

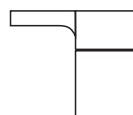

Creato

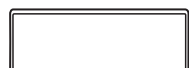

CANOPLA T3 CREATO
CR - CPD.06923

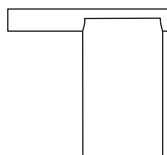

Gioia



PRENSA CANOPLA VITRA T3
CR - CPD.06120

 FORA DE LINHA



CANOPLA T3
CR - CPD.08466

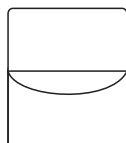

Goa



PRENSA CANOPLA GOA T3
CR - CPD.07210

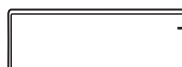

CANOPLA T3 CREATO
CR - CPD.06923

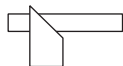

Loft

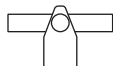

Loft Design



Innovare



Innovare Classic



Saga



Saga Cross

PRESA CANOPLA

LOFT T3

CR - CPD.06176



FORA DE LINHA

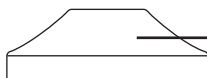

CANOPLA T3

CR - CPD.08466

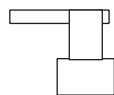

Shiva



Vitra

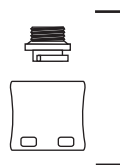

PRENSA CANOPLA VITRA T3
CR - CPD.06120



CANOPLA T3 VITRA
CR - CPD.06113



Posição Saliente

Registro de pressão 1/2", 3/4" e 1", gaveta base 1/2" e 3/4" - Posição saliente

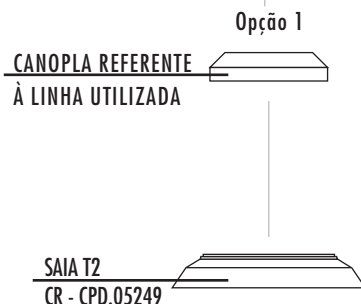
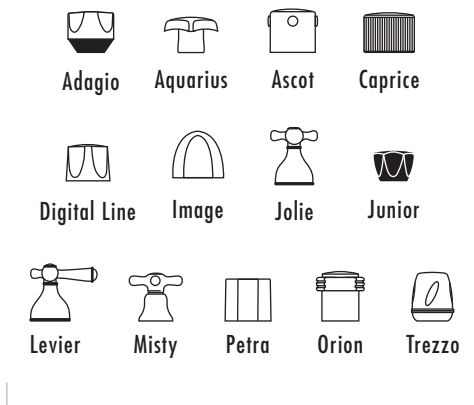
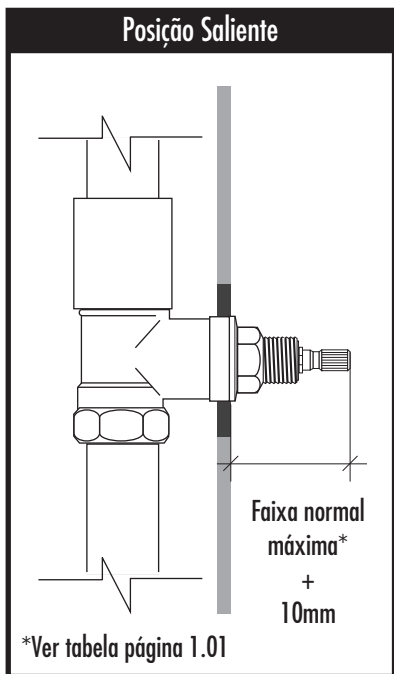

As soluções apresentadas nesta página atendem também a registros salientes de bases concorrentes.

Registro de pressão 1/2", 3/4" e 1" e gaveta base 1/2" e 3/4" - Posição saliente

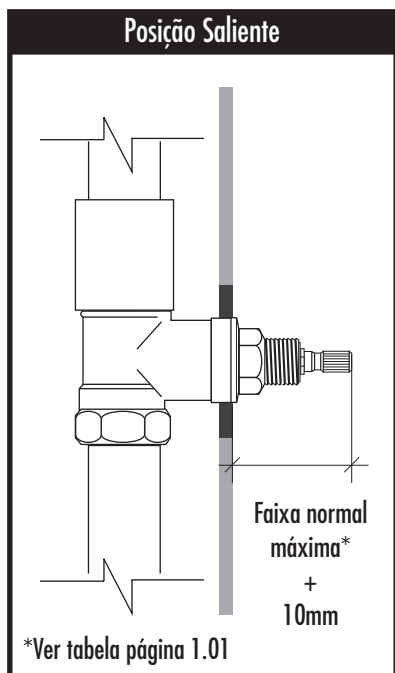

CANOPLA ALTA SOHO
CR - CPD.04837

As soluções apresentadas nesta página atendem também a registros salientes de bases concorrentes.
Esta solução substitui a canopla que acompanha o acabamento.

Registro de pressão 1/2", 3/4" e 1" e gaveta base 1/2" e 3/4" - Posição saliente

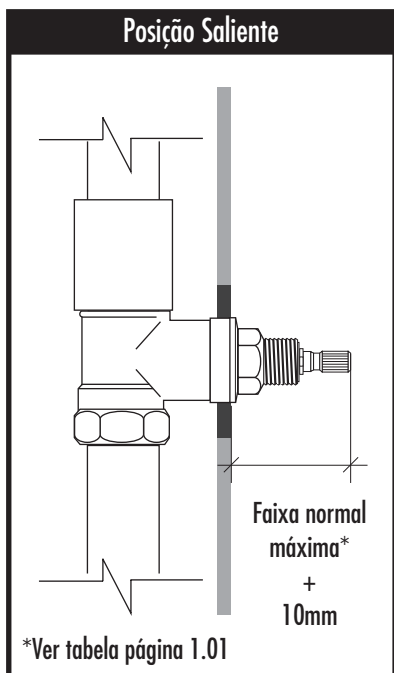

Innovare



Innovare Classic



Saga



Saga Cross

SAIA T2
CR - CPD.05249

As soluções apresentadas nesta página atendem também a registros salientes de bases concorrentes.

Registro de pressão 1/2", 3/4" e 1" e gaveta base 1/2" e 3/4" - Posição saliente

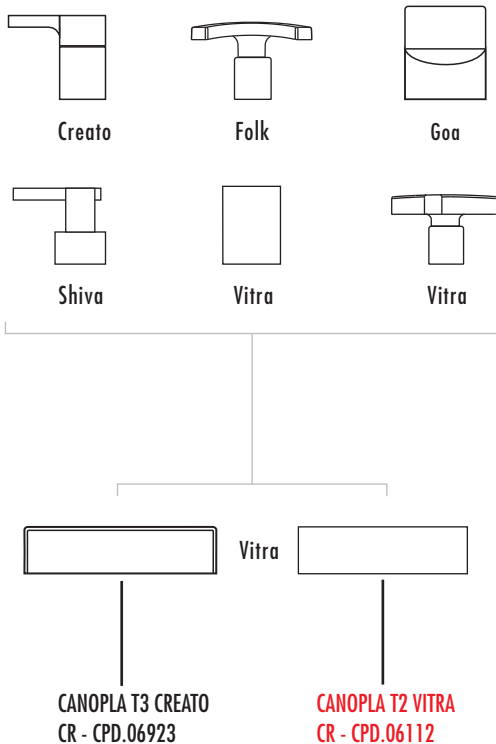
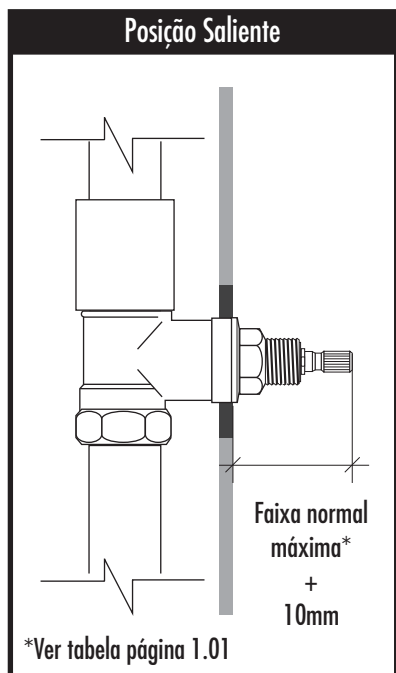

As soluções apresentadas nesta página atendem também a registros salientes de bases concorrentes.
Esta solução substitui a canopla que acompanha o acabamento.

Posição Saliente

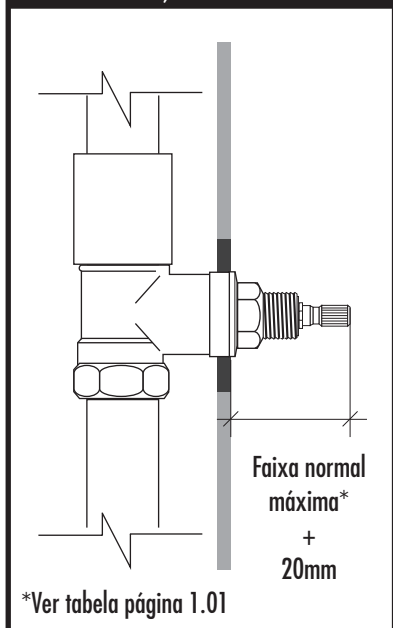

Registro de pressão 3/4" e 1" e Registro de gaveta base 3/4" - Posição saliente



Adagio



Aquarius



Ascot



Caprice



Digital Line



Image



Jolie



Junior



Levier



Misty



Petra



Orion



Trezzo

Opção 2

CANOPLA ALTA T1/T2
CR - CPD.08595

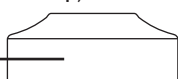

SAIA T2
CR - CPD.05249



Opção 1

CANOPLA REFERENTE
À LINHA UTILIZADA

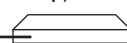

SAIA ALTA T2
CR - CPD.06293



As soluções apresentadas nesta página atendem também a registros salientes de bases concorrentes.

Posição Saliente

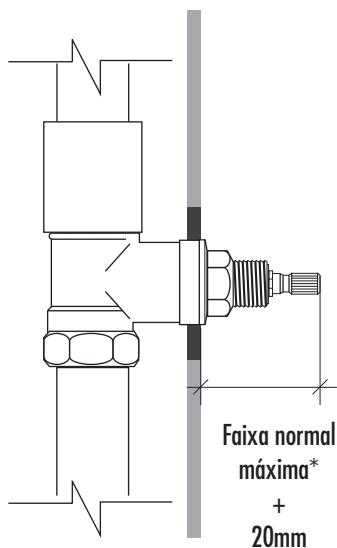

*Ver tabela página 1.01

Registro de pressão 3/4" e 1" e Registro de gaveta base 3/4" - Posição saliente

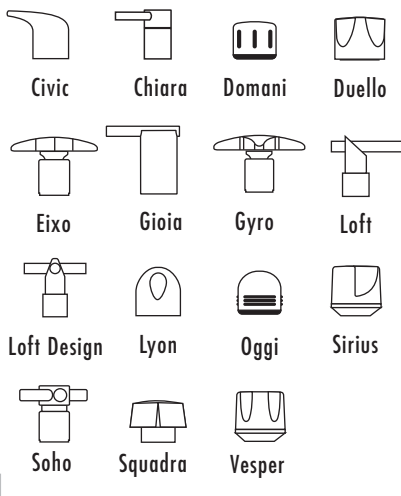
CANOPLA ALTA SOHO
CR - CPD.04837SAIA T2
CR - CPD.05249

As soluções apresentadas nesta página atendem também a registros salientes de bases concorrentes.

Esta solução substitui a canopla que acompanha o acabamento.

Posição Saliente

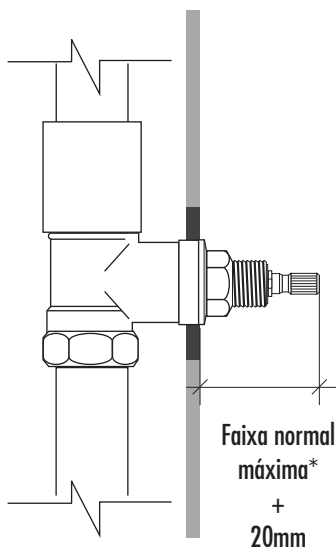

*Ver tabela página 1.01

Registro de pressão 3/4" e 1" e Registro de gaveta base 3/4" - Posição saliente



Innovare



Innovare Classic



Saga



Saga Cross

SAIA ALTA T2
CR - CPD.06293

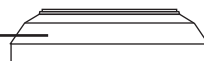

As soluções apresentadas nesta página atendem também a registros salientes de bases concorrentes.

Posição Saliente

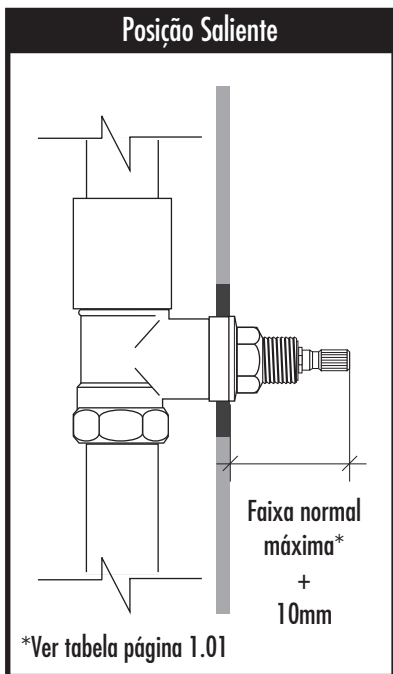

Registro gaveta base 1" - Posição saliente



Adagio



Aquarius



Ascot



Caprice



Digital Line



Image



Jolie



Junior



Levier



Misty



Petra



Orion



Trezzo

Opção 2

CANOPLA ALTA T1/T2
CR - CPD.08595

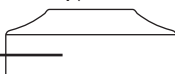

Opção 1

CANOPLA REFERENTE
À LINHA UTILIZADA

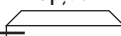

SAIA T2
CR - CPD.05249



SAIA ALTA T2
CR - CPD.06293



As soluções apresentadas nesta página atendem também a registros salientes de bases concorrentes.

Posição Saliente

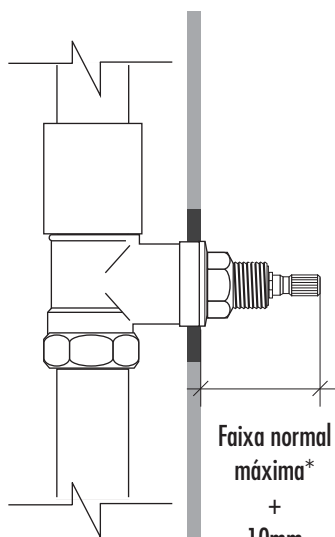

*Ver tabela página 1.01

Registro gaveta base 1" - Posição saliente

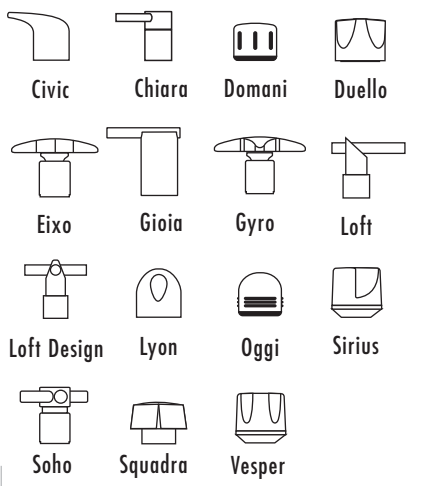
CANOPLA ALTA SOHO
CR - CPD.04837SAIA T2
CR - CPD.05249

As soluções apresentadas nesta página atendem também a registros salientes de bases concorrentes.
Esta solução substitui a canopla que acompanha o acabamento.

Posição Saliente

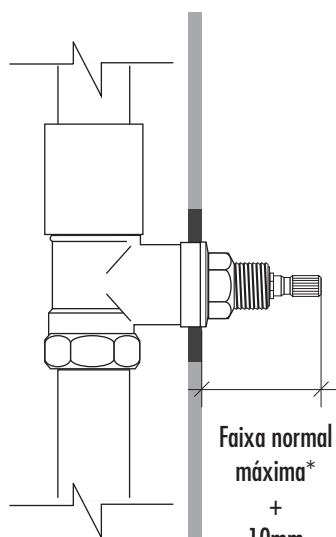

*Ver tabela página 1.01

Registro de gaveta base 1" - Posição saliente



Innovare



Innovare Classic



Saga



Saga Cross

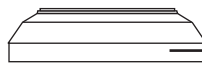

SAIA ALTA T2
CR - CPD.06293

As soluções apresentadas nesta página atendem também a registros salientes de bases concorrentes.

Posição Saliente

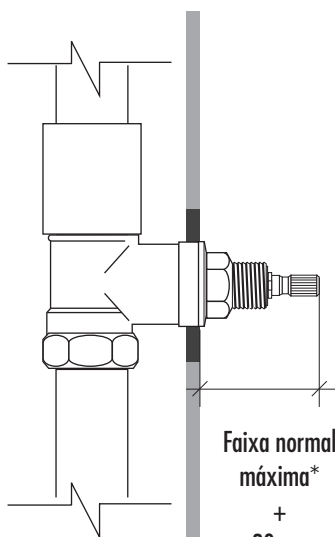

*Ver tabela página 1.01

Faixa normal
máxima*
+
20mm

Registro gaveta base 1" - Posição saliente



Adagio



Aquarius



Ascot



Caprice



Digital Line



Image



Jolie



Junior



Levier



Misty



Petra



Orion

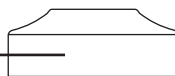

Trezzo

CANOPLA ALTA T1/T2
CR - CPD.08595SAIA ALTA T2
CR - CPD.06293

As soluções apresentadas nesta página atendem também a registros salientes de bases concorrentes.
Esta solução substitui a canopla que acompanha o acabamento.

Posição Saliente

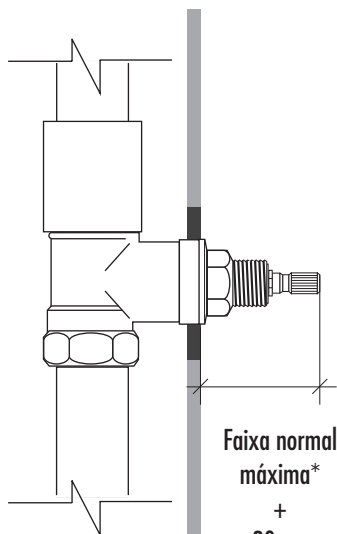

*Ver tabela página 1.01

Faixa normal
máxima*
+
20mm

Registro de gaveta base 1" - Posição saliente

CANOPLA ALTA SOHO
CR - CPD.04837SAIA ALTA T2
CR - CPD.06293

As soluções apresentadas nesta página atendem também a registros salientes de bases concorrentes.

Esta solução substitui a canopla que acompanha o acabamento.

Registro de gaveta base 1 1/4" e 1 1/2" - Posição saliente

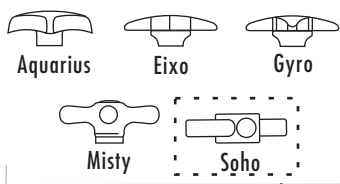

PRENSA CANOPLA SOHO T3
CR - CPD.06175



FORA DE LINHA

Atualmente utiliza sistema Fabrieasy Página 1.34

CANOPLA ALTA T3
CR - CPD.02508
AC - CPD.03998



FORA DE LINHA

Posição Saliente

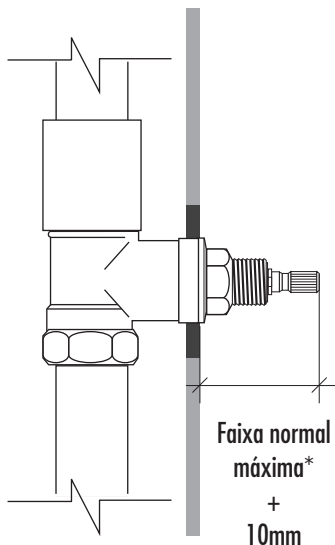

*Ver tabela página 1.01

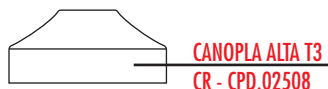

FORA DE LINHA

Esta solução substitui a canopla que acompanha o acabamento.

Registro de gaveta base 1 1/4" e 1 1/2" - Posição saliente



Innovare



Innovare Classic

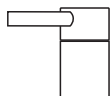

Chiara



Loft



Loft Design



Saga



Saga Cross



Soho

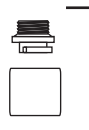

**PRENSA CANOPLA
LOFT T3
CPD.06176**

FORA DE LINHA

Posição Saliente

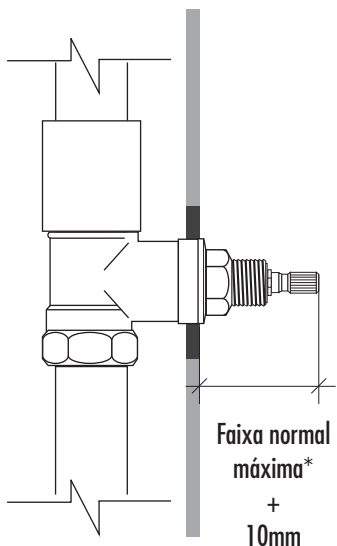

Faixa normal
máxima*
+
10mm

*Ver tabela página 1.01

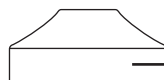

**CANOPLA ALTA T3
CR - CPD.02508**

FORA DE LINHA

As soluções apresentadas nesta página atendem também a registros salientes de bases concorrentes.

Registro de pressão/gaveta base 1/2", 3/4" e 1" - Posição enterrado



Atualmente utiliza sistema Fabrieasy
Página 1.36

Soho



Eixo



Adagio



Aquarius



Ascot



Caprice

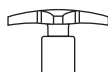

Folk



Zeta



Gyro



Digital Line



Domani



Duello



Image



Jolie



Lyon



Misty



Oggi



Orion



Petra



Sirius



Squadra



Trezzo



Vesper

PRENSA CANOPLA LONGO GYRO
CPD.07257

FORA DE LINHA

Cromado

Cinza

PRENSA CANOPLA LONGO SOHO
CR - CPD.04301



POSIÇÃO ENTERRADO

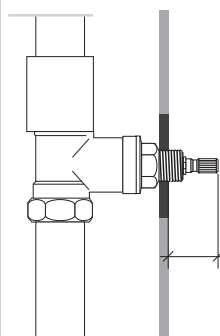

entre 24 e 37 mm - A1
entre 37 e 47 mm - A2



PRENSA CANOPLA LONGO
CPD.03257

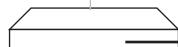

CANOPLA REFERENTE À LINHA UTILIZADA

Registro de pressão/gaveta base 1/2", 3/4" e 1" - Posição enterrado



Levier

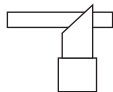

Loft



Loft Design



Civic



Chiara



Creato



Soho



PRENSA CANOPLA LONGO
CERÂMICO
CPD.03258

SALVA REGISTRO FABRIEASY
CPD.06884

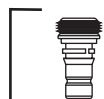

Chave saca volante



CANOPLA REFERENTE
À LINHA UTILIZADA

CANOPLA REFERENTE
À LINHA UTILIZADA

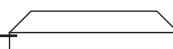

POSIÇÃO ENTERRADO

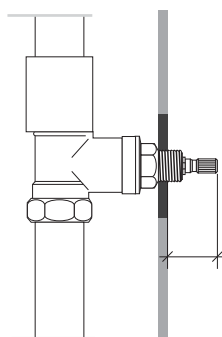

entre
24 e 37 mm - A1
entre
37 e 47 mm - A2

POSIÇÃO ENTERRADO

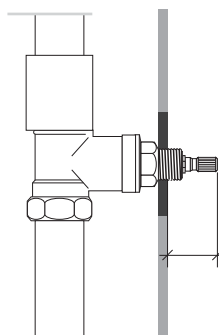

entre
24 e 37 mm - A1
entre
37 e 47 mm - A2

Registro de pressão/gaveta base 1/2", 3/4" e 1"
Posição enterrado



Gioia



Goa



Shiva



Vitra



Simetria



Lucca



PRESNA CANOPLA
CLICK LONGO
CPD.06320

CANOPLA REFERENTE
À LINHA UTILIZADA



POSIÇÃO ENTERRADO

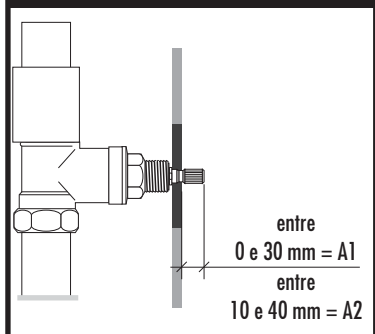

Registro de pressão/gaveta base 1/2", 3/4" e 1"
Posição enterrado

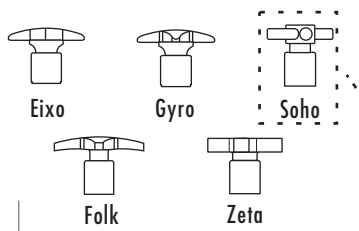
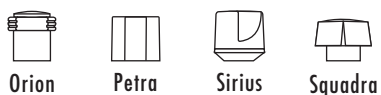
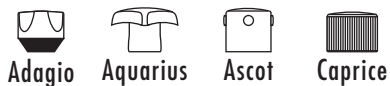

Atualmente utiliza sistema Fabrieasy
Página 1.39



PRENSA CANOPLA
SOHO
CR - CPD.04282



PRENSA CANOPLA
ABA
CPD.03256

EXTENSOR SALVA REGISTRO
CPD.03259

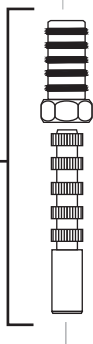

CANOPLA REFERENTE
À LINHA UTILIZADA



Para peças enterradas além deste limite utilize dois ou mais extensores em conjunto.

Registro de pressão/gaveta base 1/2", 3/4" e 1" - Posição enterrado

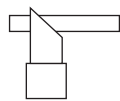

Loft

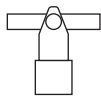

Loft Design



Chiara



Creato



Innovare



Innovare Classic

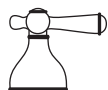

Levier

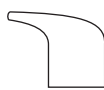

Civic



Soho



Saga



Saga Cross

PRENSA CANOPLA
MECANISMO CERÂMICO
CPD.02108



EXTENSOR SALVA REGISTRO
CPD.03259

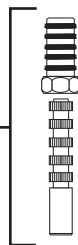

EXTENSOR SALVA
REGISTRO
CPD.03259

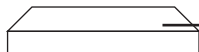
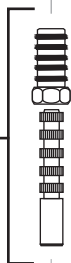

CANOPLA REFERENTE
À LINHA UTILIZADA

Para peças enterradas além deste limite
utilize duas ou mais peças em conjunto.

POSIÇÃO ENTERRADO

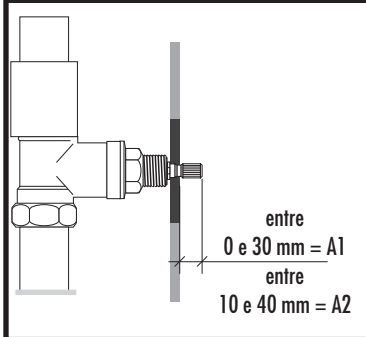

POSIÇÃO ENTERRADO

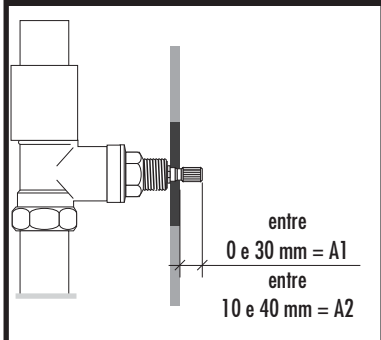
Registro de pressão/gaveta base 1/2", 3/4" e 1"
Posição enterrado

Gioia



Goa



Shiva



Vitra



Simetria

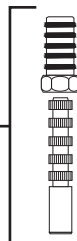

Lucca

PRENSA CANOPLA
CLICK
CPD.06118EXTENSOR SALVA REGISTRO
CPD.03259CANOPLA REFERENTE
À LINHA UTILIZADA

Para peças enterradas além deste limite
utilize duas ou mais peças em conjunto.

POSIÇÃO ENTERRADO

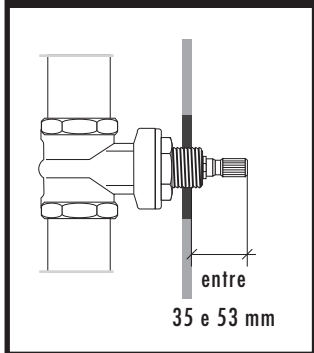

Registro de gaveta base 1 1/4" e 1 1/2"
Posição enterrado

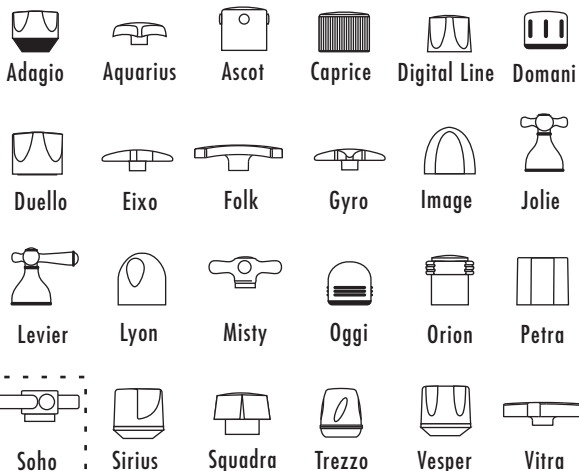

Atualmente utiliza sistema Fabrieasy
Página 1.43

CANOPLA REFERENTE
À LINHA UTILIZADA



Obs: para registros enterradas de 54 à 59 combinar esta solução com canopla alta T3.



SALVA REGISTRO
GAVETA
1 1/4" E 1 1/2"
CPD.03870

POSIÇÃO ENTERRADO

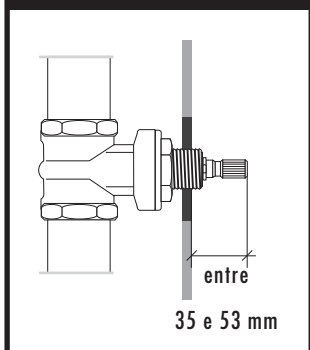
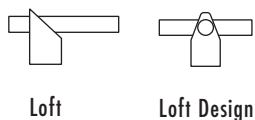
Registro de gaveta base 1 1/4" e 1 1/2"
Posição enterrado

CANOPLA REFERENTE
À LINHA UTILIZADA

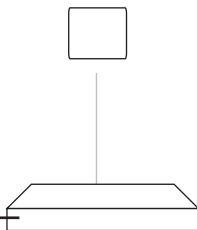

Obs: para registros enterradas de 54 à 59 combinar esta solução com canopla alta T3.

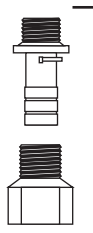

SALVA REGISTRO
GAVETA
1 1/4" E 1 1/2"
CPD.03870

POSIÇÃO ENTERRADO

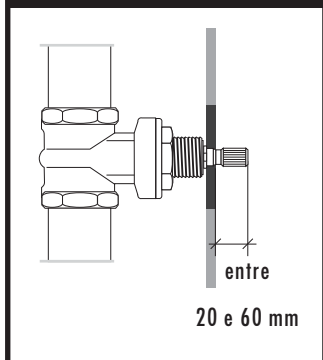
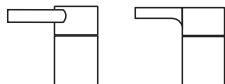
Registro de gaveta base 1 1/4" e 1 1/2"
Posição enterrado

Chiara

Creato

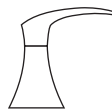

Innovare



Innovare Classic



Soho



Saga



Saga Cross

EXTENSOR SALVA
REGISTRO FABRIEASY T3
CPD.07176

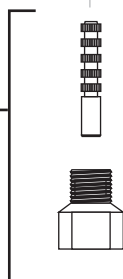

EXTENSOR SALVA
REGISTRO T3
CPD.04030



FORA DE LINHA

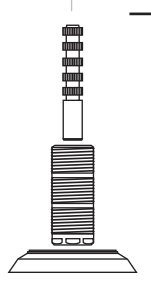

Para peças enterradas além desse limite utilize 2 ou mais peças em conjunto. Este modelo só serve para as linhas Innovare e Saga.

POSIÇÃO ENTERRADO

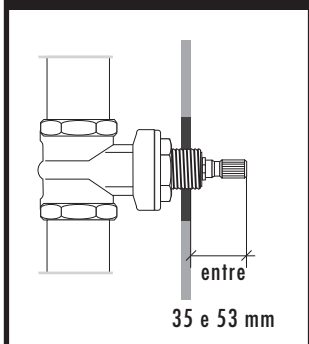

Registro de gaveta base 1 1/4" e 1 1/2"
Posição enterrado



Gioia



Shiva



Vitra



Simetria



CANOPLA REFERENTE
À LINHA UTILIZADA



Obs: para registros enterradas de 54 à 59 combinar esta solução com canopla alta T3.



SALVA REGISTRO
GAVETA
1 1/4" E 1 1/2"
CPD.03870

Conversores para registros da concorrência

Os conversores apresentados nas páginas seguintes se adaptam aos seguintes registros:

- pressão 1/2", 3/4" e 1" - tamanho 1
- gaveta 1/2 e 3/4" - tamanho 1
- gaveta 1" - tamanho 2
- gaveta 1 1/4 e 1 1/2 - tamanho 3

Obs: para acabamentos A3 a conversão só é possível com a troca do volante, portanto a solução mais simples é a devolução do acabamento e a troca por outro adequado a base instalada.

OBSERVAÇÕES SOBRE BASES DA CONCORRÊNCIA:

Para bases salientes: utilize as mesmas soluções das bases Fabrimar.

Para bases enterradas utilize:

- kit prolongador da base do concorrente + conversor Fabrimar.

Conversores para registros Deca



Adagio



Ascot



Caprice



Digital Line



Domani



Duello



Image



Jolie



Lyon



Oggi



Orion



Petra



Sirius



Squadra



Trezzo



Vesper P

CONVERSOR

DECA

CR - CPD.03156

BR - CPD.03356

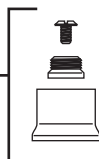

CONVERSOR

DECA LONGO

CR - CPD.03160

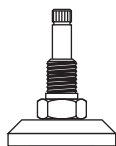
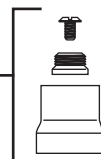

Acabamento 1
1/2" e 3/4"

CANOPLA REFERENTE
À LINHA UTILIZADA

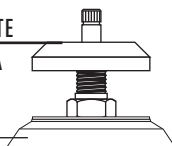

Acabamento 2
1"

SAIA T2
CR - CPD.05249

CANOPLA T3
CR - CPD.08466

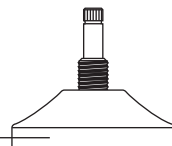

Acabamento 3
1 1/4" e 1 1/2"

CANOPLA REFERENTE
À LINHA UTILIZADA

Conversores para registros Docol



Adagio



Ascot



Caprice



Digital Line



Domani



Duello



Image



Jolie



Lyon



Oggi



Orion



Petra



Sirius



Squadra



Trezzo



Vesper P



CONVERSOR
DOCOL
CR - CPD.03158

CANOPLA REFERENTE
À LINHA UTILIZADA

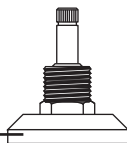

Acabamentos
Pequenos
1/2" e 3/4"

CANOPLA GRANDE DOCOL
CR - CPD.06179

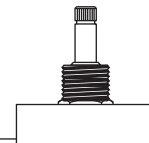

Acabamentos
Grandes
1", 1 1/4" e 1 1/2"

Conversores para registros Deca - Azul



Levier

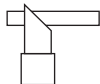

Loft



Loft Design

CONVERSOR DECA CERÂMICO
CR - CPD.03157

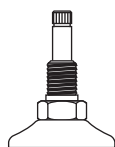
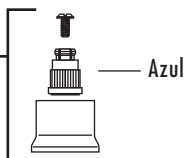

Acabamento 1
1/2" e 3/4"

CANOPLA REFERENTE
À LINHA UTILIZADA

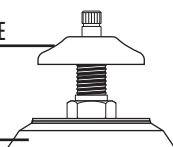

SAIA T2
CR - CPD.05249

Acabamento 2
1"

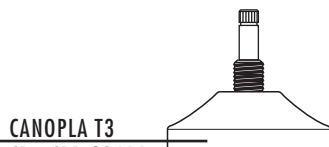

CANOPLA T3
CR - CPD.08466

Acabamento 3
1 1/4" e 1 1/2"

CANOPLA REFERENTE
À LINHA UTILIZADA

Conversores para registros Docol - Verde

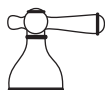

Levier

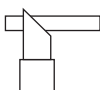

Loft



Loft Design

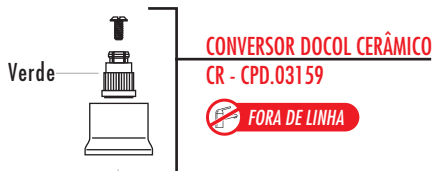

CANOPLA REFERENTE
À LINHA UTILIZADA

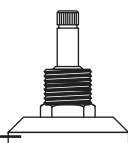

Acabamentos
Pequenos
1/2" e 3/4"

CANOPLA GRANDE
DOCOL
CR - CPD.06179

FORA DE LINHA

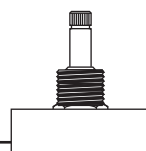

Acabamentos
Grandes
1", 1 1/4" e 1 1/2"

Conversores para registros Deca - Azul



Aquarius



Eixo



Gyro

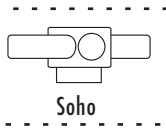

Soho

Atualmente utiliza sistema Fabrieasy
Página 1.57

CONVERSOR DECA FOLK
CR - CPD.07363

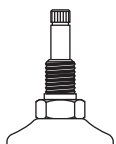

Acabamento 1
1/2" e 3/4"

CANOPLA REFERENTE
À LINHA UTILIZADA

CANOPLA REFERENTE
À LINHA UTILIZADA

SAIA T2
CR - CPD.05249

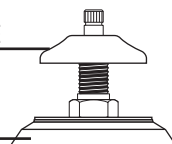

Acabamento 2
1"

Conversores para registros Docol - Verde



Aquarius



Eixo



Gyro



Soho

Atualmente utiliza sistema Fabrieasy
Página 1.58

CONVERSOR DOCOL SOHO
CR - CPD.04309



Verde

CANOPLA REFERENTE
À LINHA UTILIZADA

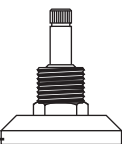

Acabamentos Pequenos
1/2" e 3/4"

CANOPLA GRANDE
DOCOL
CR - CPD.06179

FORA DE LINHA

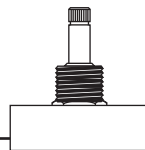

Acabamentos Grandes
1", 1 1/4" e 1 1/2"

Conversores para registros Deca - Azul

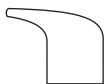

Civic

CONVERSION DECA CERÂMICO
CR - CPD.03157

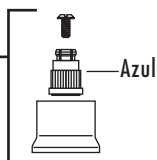

CANOPLA OGGI
CR - CPD.02578

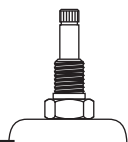

Acabamento 1
1/2", 3/4" e 1"

Conversores para registros Docol - Verde

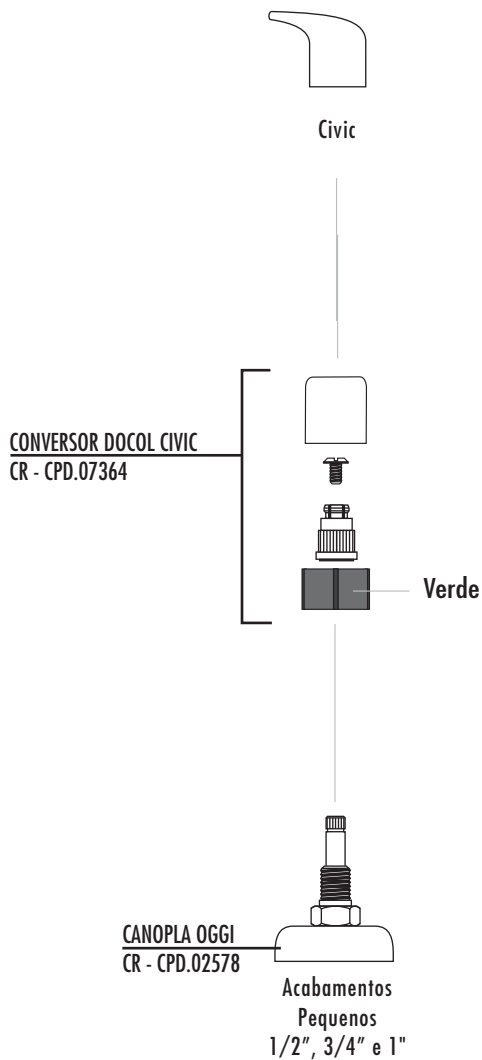

Conversores para registros Deca



Misty

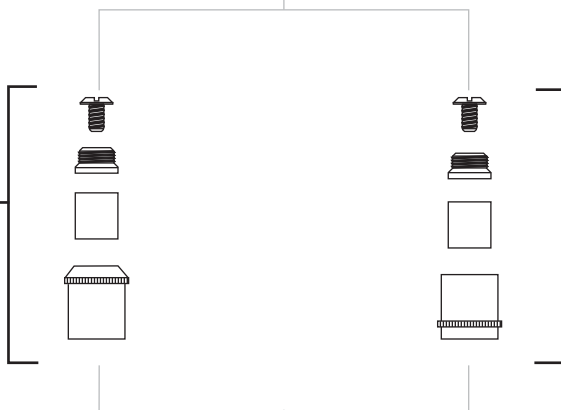

CONVERSOR
DECA MISTY
CR - CPD.04818



CONVERSOR
DECA MISTY T3
CR - CPD.06177

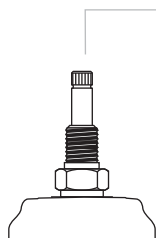
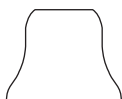

Acabamento 1
1/2" e 3/4"

CANOPLA MISTY
CR - CPD.03146

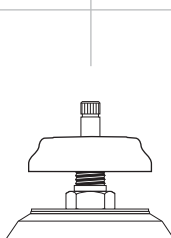

Acabamento 2
1"

SAIA T2
CR - CPD.05249

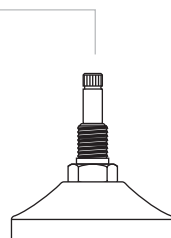

Acabamento 3
1 1/4" e 1 1/2"

CANOPLA T3
CR - CPD.08466

Conversores para registros Deca - Azul



Folk



Vitra

CONVERSOR DECA FOLK
CR - CPD.07363



CANOPLA FOLK
CR - CPD.06415



FORA DE LINHA

Acabamentos
Pequenos
1/2", 3/4" e 1"

Conversores para registros Docol - Verde



Folk

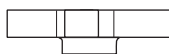

Zeta

CONVERSOR DOCOL SOHO
CR - CPD.04309



Verde

CANOPLA FOLK
CR - CPD.06415



FORA DE LINHA

Acabamentos Pequenos
1/2" e 3/4"

CANOPLA GRANDE
DOCOL VITRA
CR - CPD.06210



FORA DE LINHA

Acabamentos Grandes
1", 1 1/4" e 1 1/2"

Acabamentos convertidos para registros Deca

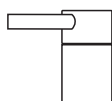

Chiara

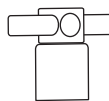

Soho

CANOPLA SQUADRA
CR - CPD.03838



FORA DE LINHA

Acabamentos
Pequenos
1/2", 3/4" e 1"

CANOPLA T3 CHIARA
CR - CPD.06919



FORA DE LINHA

Acabamentos
Grandes
1 1/4" e 1 1/2"

Acabamentos convertidos para registros Docol

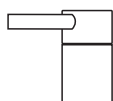

Chiara

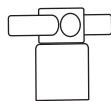

Soho

CANOPLA SQUADRA
CR - CPD.03838

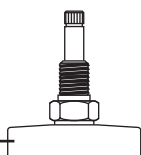

Acabamentos
Pequenos
1/2", 3/4" e 1"

**CANOPLA GRANDE
DOCOL**

CR - CPD.06179

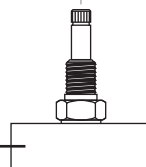

Acabamentos
Grandes
1 1/4" e 1 1/2"

Acabamentos convertidos
para registros Deca

Conversor para registros Deca

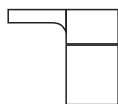

Creado

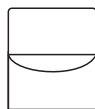

Goa

CONVERSOR DECA GOA PEQ
CR - CPD.07211



CONVERSOR DECA GOA GR
CR - CPD.07212

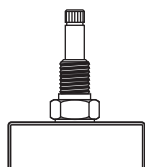
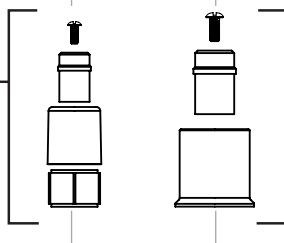

Acabamentos
Pequenos
1/2", 3/4" e 1"

CANOPLA DECA CREADO
CR - CPD.06924

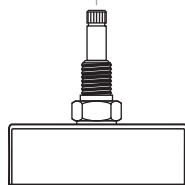

Acabamentos
Grandes
1 1/4" e 1 1/2"

CANOPLA T3 CREADO
CR - CPD.06923

Acabamentos convertidos para registros Docol

Conversor para registros Docol

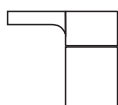

Creato

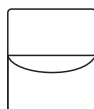

Goa



CONVERSOR DOCOL GOA GR
CR - CPD.07213

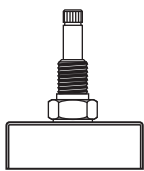

Acabamentos Pequenos
1/2", 3/4" e 1"

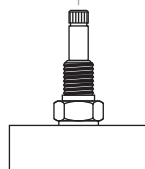

Acabamentos Grandes
1 1/4" e 1 1/2"

CANOPLA DECA CREATO
CR - CPD.06924



CANOPLA GRANDE DOCOL
CR - CPD.06179



Acabamentos convertidos para registros Deca

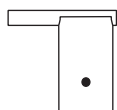

Gioia



Usar chave Allen 3/32"
(não inclusa)

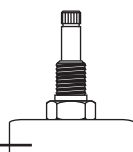
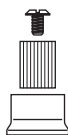

CANOPLA SOHO
CR - CPD.04280



FORA DE LINHA

Acabamentos
Pequenos
1/2", 3/4" e 1"

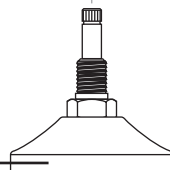

CANOPLA T3
CR - CPD.08466

Acabamentos
Grandes
1 1/4" e 1 1/2"

Acabamentos convertidos para registros Docol

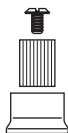
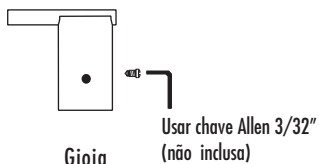

CANOPLA SOHO
CR - CPD.04280



FORA DE LINHA

Acabamentos
Pequenos
1/2" e 3/4"

**CANOPLA GRANDE
DOCOL**

CR - CPD.06179



FORA DE LINHA

Acabamentos
Grandes
1", 1 1/4" e 1 1/2"

Acabamentos convertidos para registros Deca e Docol

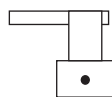

Shiva

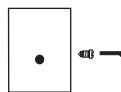

Vitra

Usar chave Allen 3/32"
(não inclusa)

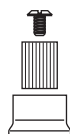

Deca

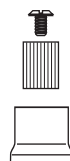

Docol

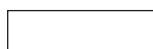

Acabamentos Pequenos
1/2", 3/4" e 1"

CANOPLA PEQUENA
DECA VITRA
CR - CPD.06209



Acabamentos Grandes
1 1/4" e 1 1/2"

CANOPLA GRANDE
DECA VITRA
CR - CPD.06212

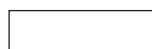

Acabamentos Pequenos
1/2" e 3/4"

CANOPLA TI VITRA
CR - CPD.06111



Acabamentos Grandes
1", 1 1/4" e 1 1/2"

CANOPLA GRANDE
DOCOL VITRA
CR - CPD.06210



GAVETA BRUTO

Página 2.01

GAVETA BASE

Página 2.02

PRESSÃO BASE

Página 2.06

BORBOLETA

Página 2.10

MECANISMO CERÂMICO

Página 2.11

GAVETA BRUTO 1510 B 1/2" a 2"

Volante Plástico - Verde
(compatível com registros com volante metálico)

CASTELO 1510 B

1/2" - CPD.01198

3/4" - CPD.01199

1" - CPD.01200

1 1/4" - CPD.01201

1 1/2" - CPD.01202

2" - CPD.01203*

* vem com duas gavetas

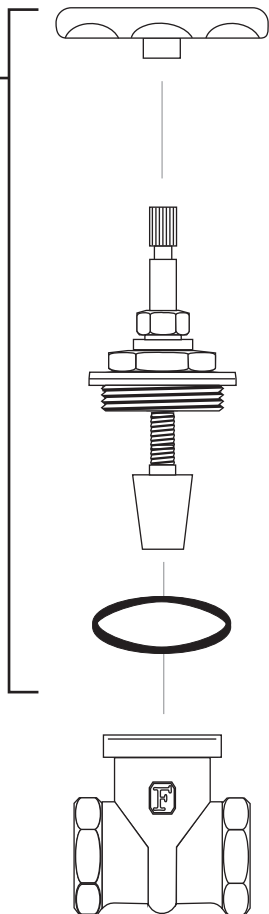

ACIONADOR 1510 B VOLANTE PLÁSTICO VERDE

1/2", 3/4" e 1"

CPD.01779

1 1/4" a 2"

CPD.01781

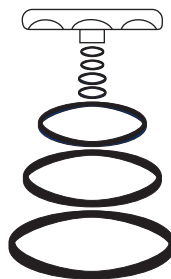

GAVETA BASE 1/2" à 1 1/2"

Atual

CASTELO B 1509

1/2" - CPD.01118

3/4" - CPD.06353*

1" - CPD.00892

1 1/4" - CPD.00891

1 1/2" - CPD.00890

* Vem com duas gavetas



Obs.: Para facilitar a identificação, neste modelo o castelo possui sextavado baixo e largo.

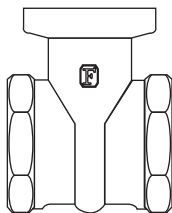

Atual 1/2" a 1"

Atual 1 1/4" a 1 1/2"

Antigo 1/2" a 1"

Antigo 1 1/4" a 1 1/2"



VEDAÇÃO REGISTRO GAVETA 1/2" A 1 1/2"

CPD.01122

GAVETA BASE 1" a 1 1/2"

Antigo

CASTELO B 1509 ANTIGO

1" - CPD.08837

1 1/4" - CPD.08844

1 1/2" - CPD.08851

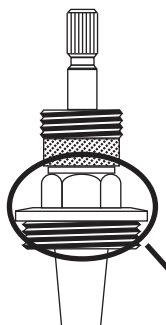

Obs.: Para facilitar a identificação, neste modelo o castelo possui sextavado alto e estreito.

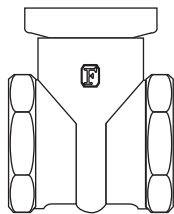

Atual 1/2" a 1"

Atual 1 1/4" a 1 1/2"

Antigo 1/2" a 1"

Antigo 1 1/4" a 1 1/2"



VEDAÇÃO REGISTRO GAVETA 1/2" A 1 1/2"

CPD.01122

GAVETA BASE LONGO 1/2", 3/4" e 1"

Indicado para uso em paredes de gesso acartonado ("Dry-wall")

CASTELO B 1509 LG

1/2" - CPD.03346

3/4" - CPD.03347

1" - CPD.03348

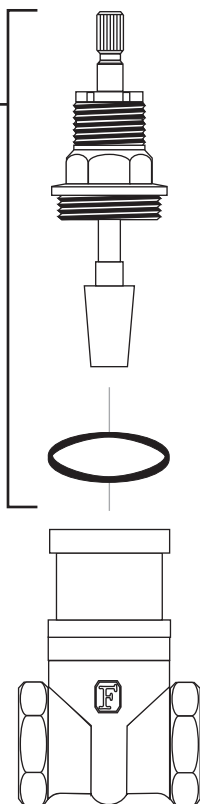

Atual 1/2" a 1"

Atual 1 1/4" a 1 1/2"

Antigo 1/2" a 1"

Antigo 1 1/4" a 1 1/2"

VEDAÇÃO REGISTRO GAVETA 1/2" A 1 1/2"

CPD.01122

GAVETA BASE FABRIWALL 3/4"

Indicado para uso em paredes de gesso acartonado ("Dry-wall")

CASTELO COMPLETO
REGISTRO GAVETA FW
CPD.04386

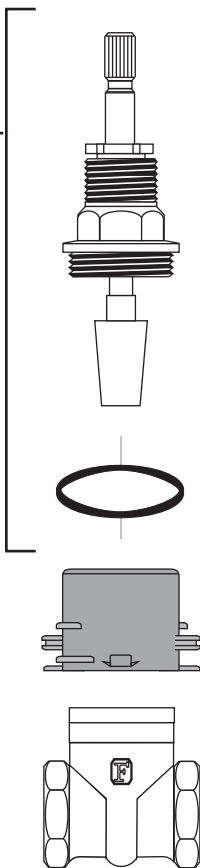

Atual 1/2" a 1"

Atual 1 1/4" a 1 1/2"

Antigo 1/2" a 1"

Antigo 1 1/4" a 1 1/2"

VEDAÇÃO REGISTRO GAVETA 1/2" A 1 1/2"

CPD.01122

PRESSÃO 1/2", 3/4"

CASTELO REGISTRO
PRESSÃO 1/2" e 3/4"
CPD.02373

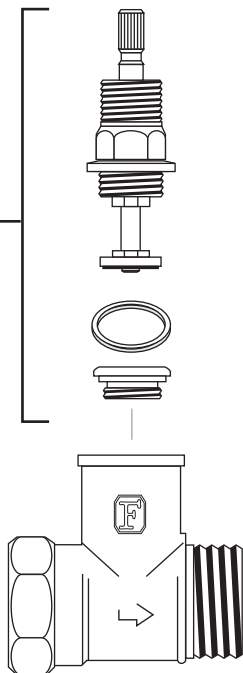

Sede M14
usar chave Allen 3/8"
(não inclusa)

VEDAÇÃO CASTELOS 1/2", 3/4"

CPD.01109

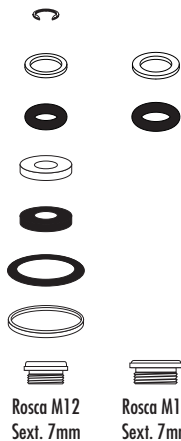

SEDE M14 VAZÃO REDUZIDA

CPD.03989



Substitui sede M14 e reduz a vazão de água.

Utilizar chave Allen 3/8"

PRESSÃO 1"

CASTELO REGISTRO PRESSÃO 1"
CPD.01588

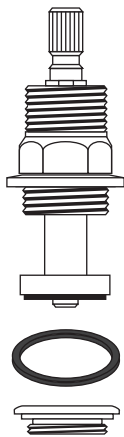

Sede M20
usar chave Allen 14mm
(não inclusa)

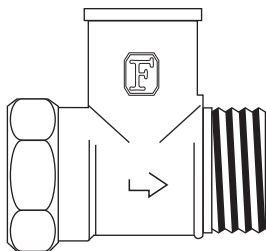

PRESSÃO LONGO 1/2", 3/4"

Indicado para uso em paredes de gesso acartonado ("Dry-wall")

CASTELO REGISTRO
PRESSÃO 1/2" e 3/4" LG
CPD.03344

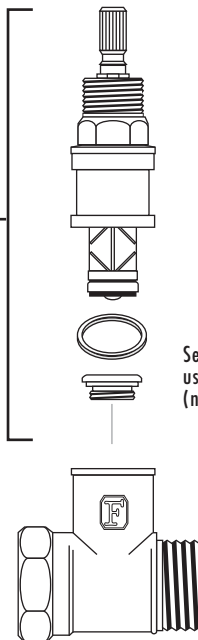

Sede M14
usar chave Allen 3/8"
(não inclusa)

VEDAÇÃO CASTELOS 1/2", 3/4"

CPD.01109

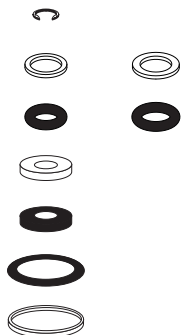

Rosca M12
Sext. 7mm

Rosca M14
Sext. 7mm

Rosca M14
Sext. 3/8"

SEDE M14 VAZÃO REDUZIDA

CPD.03989



Substitui sede M14 e reduz a vazão de água.

Utilizar chave Allen 3/8"

PRESSÃO FABRIWALL 3/4"

Indicado para uso em paredes de gesso acartonado ("Dry-wall")

CASTELO COMPLETO REGISTRO
PRESSÃO FW
CPD.04381

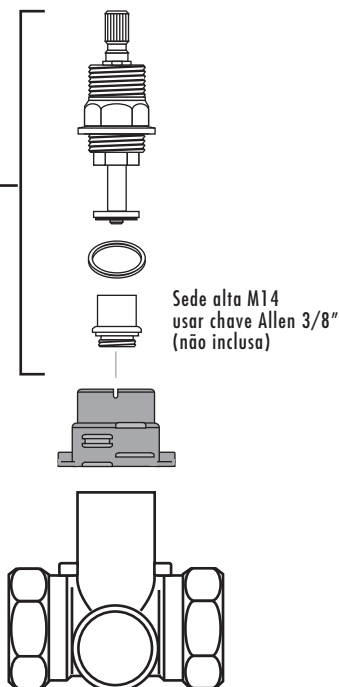

VEDAÇÃO CASTELOS 1/2", 3/4"

CPD.01109

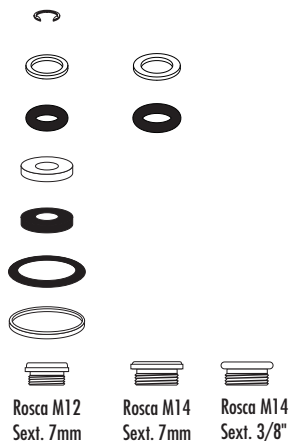

SEDE M14 VAZÃO REDUZIDA

CPD.03989



Substitui sede M14 e reduz a vazão de água.

Utilizar chave Allen 3/8"

BORBOLETA DE 1/2" E 3/4"

CASTELO REGISTRO PRESSÃO
BORBOLETA
CPD.01101

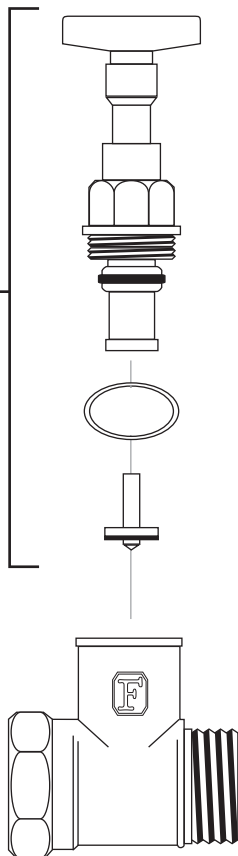

MECANISMO CERÂMICO
3/4" FECHAMENTO HORÁRIO
CPD.02084

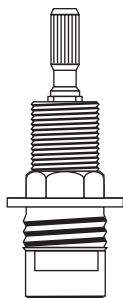

sede M22
usar chave Allen 14mm
(não inclusa)

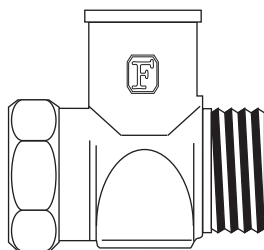

MECANISMO CERÂMICO
3/4" FECHAMENTO
ANTI-HORÁRIO
CPD.02060

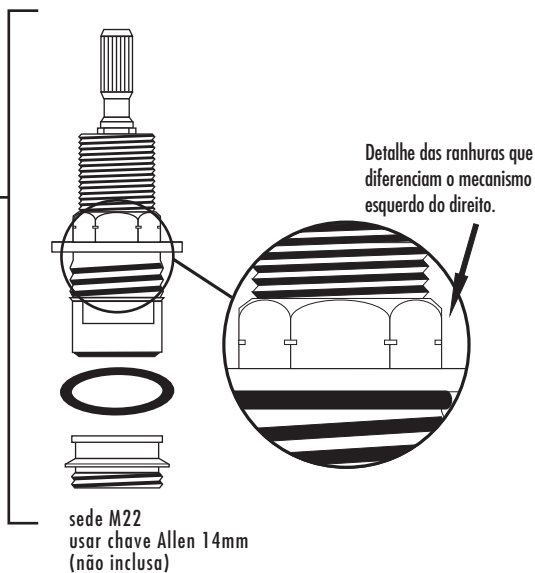

Obs.: Abre no sentido horário.

Solução para inverter o sentido de abertura

MECANISMO CERÂMICO
3/4" FECHAMENTO HORÁRIO
AJUSTÁVEL
CPD.06117

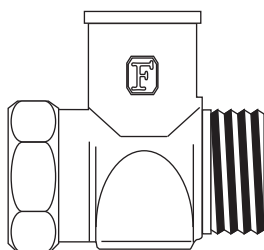
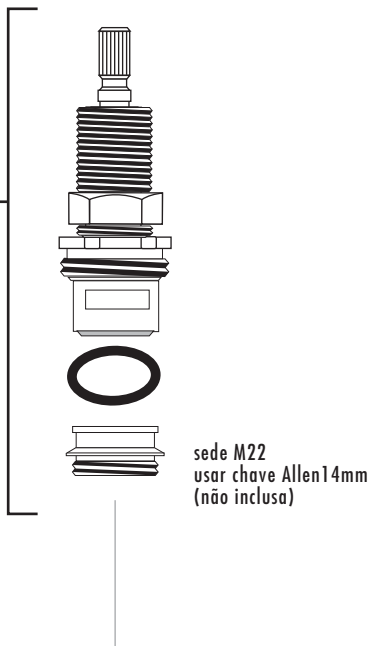

MECANISMO CERÂMICO
3/4" FECHAMENTO
ANTI-HORÁRIO
AJUSTÁVEL
CPD.06116

 **FORA DE LINHA**

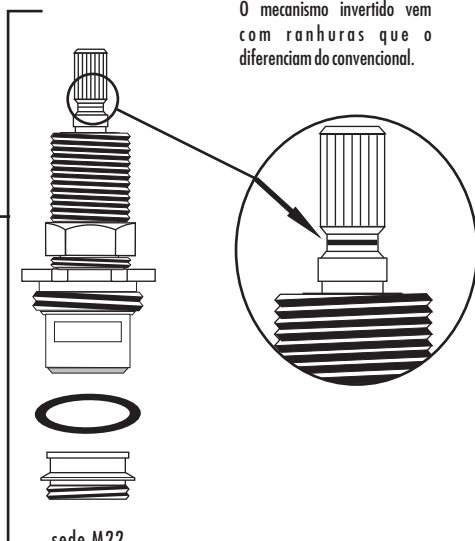

O mecanismo invertido vem com ranhuras que o diferenciam do convencional.

sede M22
usar chave Allen 14mm
(não inclusa)

Obs.: Abre no sentido horário.

Solução para inverter o sentido de abertura

MONOBLOCO PARA COZINHA

Página 3.42

TEMPERFIX

Página 3.45

MONOCOMANDOS PARA LAVATÓRIO

Página 3.46

MONOCOMANDOS PARA BIDÊ

Página 3.50

MONOCOMANDOS PARA COZINHA

Página 3.51

MONOCOMANDOS PARA CHUVEIRO

Página 3.56

ESTRUTURAS DOS MISTURADORES LAVATÓRIO BANCA EM LINHA - MAIO / 2017

ESTRUTURAS DOS MISTURADORES LAVATÓRIO BANCA					
LINHA	REF.: 1876 (Página)	REF.: 1875 (Página)	REGISTRO LATERAL	TÊ CENTRAL	VÁLVULA ESCOAMENTO
AQUARIUS	3.02		PLÁSTICO	1/2"	
ASCOT			PLÁSTICO	1/2"	
DIGITAL LINE			PLÁSTICO	1/2"	
DUELLO			PLÁSTICO	1/2"	
LYON			PLÁSTICO	1/2"	
OGGI			PLÁSTICO	1/2"	
PETRA			PLÁSTICO	1/2"	
GYRO	3.02		PLÁSTICO	1/2"	
MISTY			PLÁSTICO	1/2"	
MISTY		3.04	METÁLICO	BASECLIC	
CHIARA	3.03		METÁLICO	1/2"	SIM
GIOIA			METÁLICO	1/2"	SIM
SOHO			METÁLICO	1/2"	SIM
FOLK			METÁLICO	1/2"	SIM
ZETA			METÁLICO	1/2"	SIM
GOA			METÁLICO	1/2"	SIM
CREATO	3.04		METÁLICO	BASECLIC	SIM
DESIGN			METÁLICO	BASECLIC	SIM
LOFT			METÁLICO	BASECLIC	SIM
SHIVA	3.05		METÁLICO	BASECLIC	SIM
VITRA			METÁLICO	BASECLIC	SIM

OBS: Todas as linhas atuais são equipadas com mecanismos cerâmicos 1/4 de volta.

LINHAS COM REGISTRO LATERAL PLÁSTICO, ACIONAMENTO 1/4 DE VOLTA E TÊ CENTRAL DE 1/2".

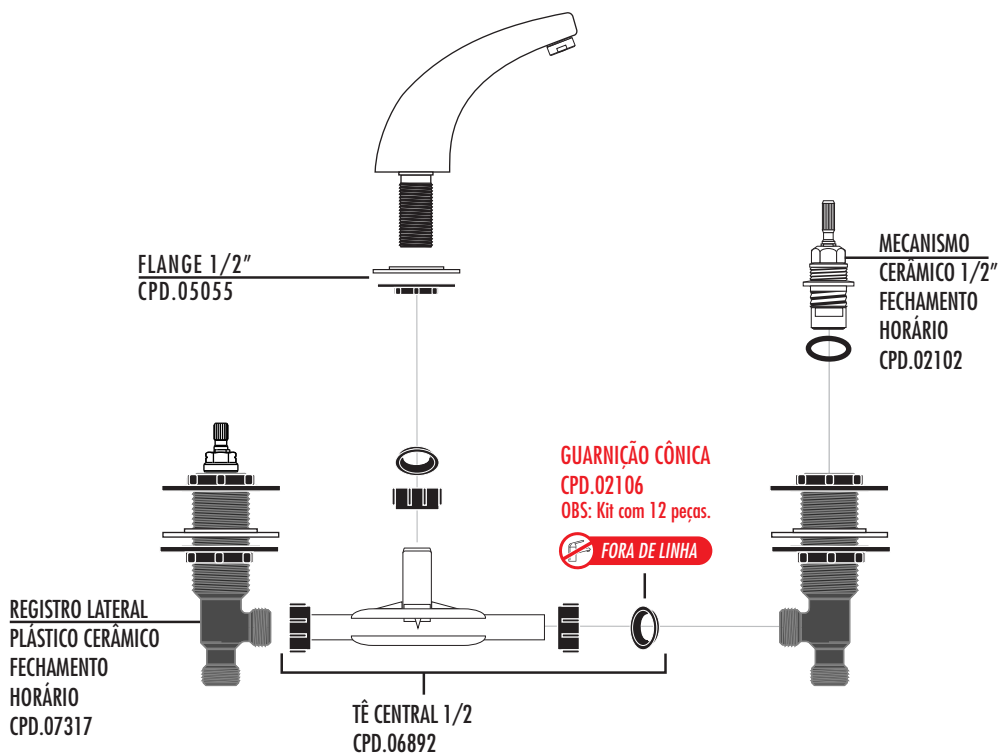

FLANGE 7/8"

CPD.07275

FORA DE LINHA



**LINHAS COM REGISTRO LATERAL METÁLICO, ACIONAMENTO 1/4 DE VOLTA
E TÊ CENTRAL DE 1/2".**

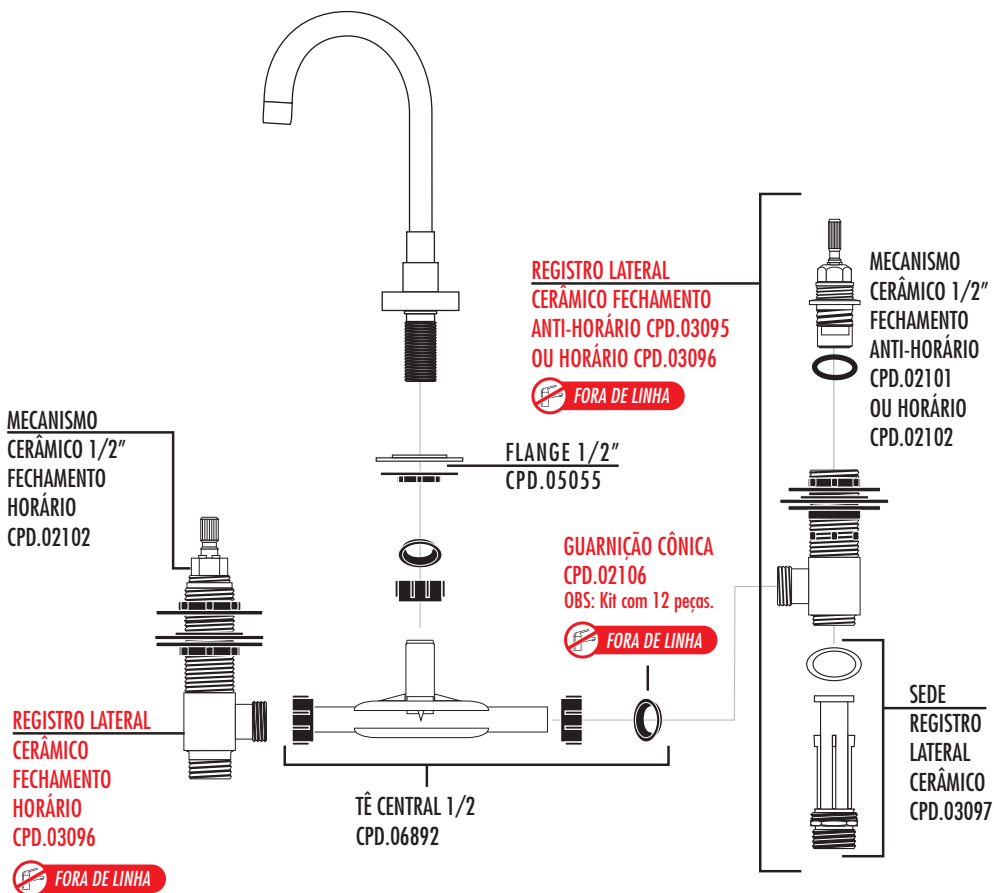

**MECANISMO CERÂMICO 1/2" FECHAMENTO ANTI-HORÁRIO
CPD.02101**

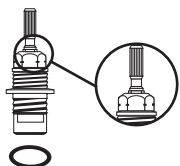

O mecanismo invertido vem com ranhuras que o diferenciam do convencional.

**LINHAS COM REGISTRO LATERAL METÁLICO, ACIONAMENTO 1/4 DE VOLTA
E TÊ CENTRAL BASECLIC.**

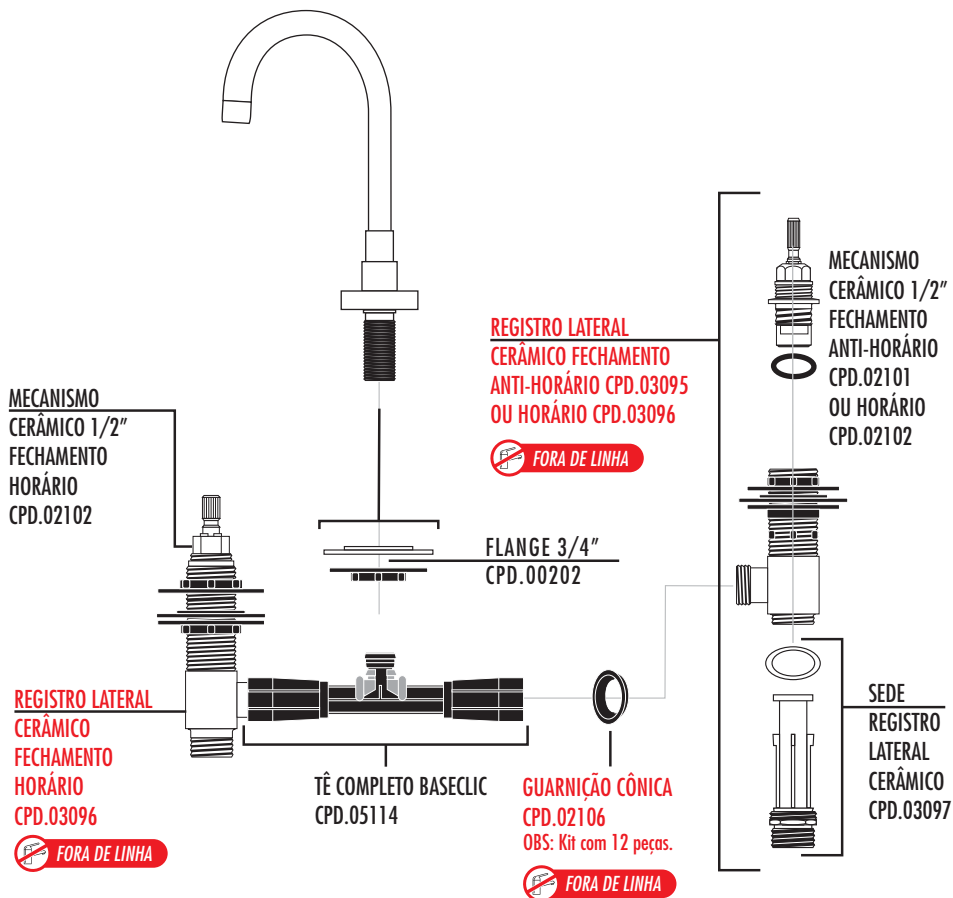

**MECANISMO CERÂMICO 1/2" FECHAMENTO ANTI-HORÁRIO
CPD.02101**

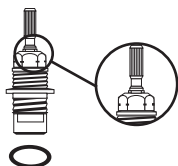

O mecanismo invertido vem com ranhuras que o diferenciam do convencional.

LINHAS COM REGISTRO LATERAL METÁLICO, ACIONAMENTO 1/4 DE VOLTA AJUSTÁVEL E TÊ CENTRAL BASECLIC.

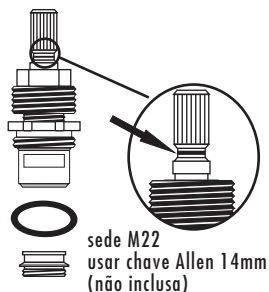
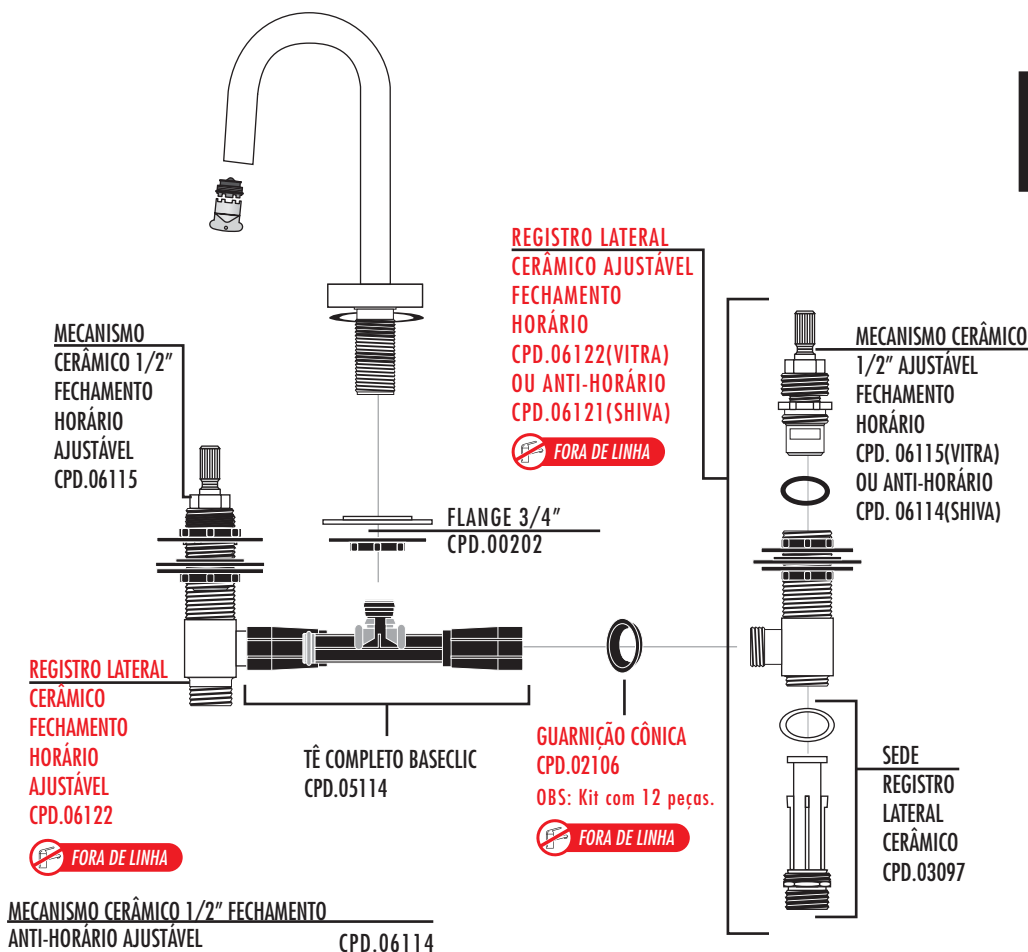

O mecanismo invertido vem com ranhuras que o diferenciam do convencional.
 Obs.: Abre no sentido horário.

DETALHAMENTO DE REPAROS

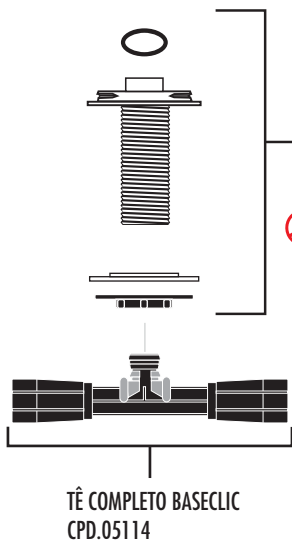

FLANGE
DE BICO
CPD.00183

FORA DE LINHA

REGISTRO
LATERAL
BASECLIC
CPD.00513

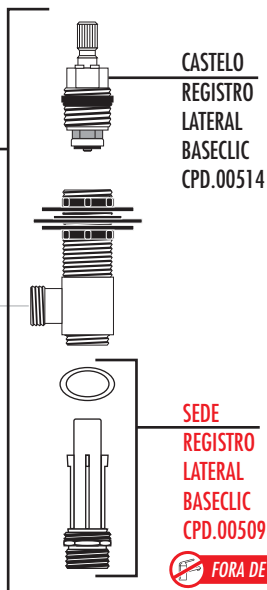

CASTELO
REGISTRO
LATERAL
BASECLIC
CPD.00514

SEDE
REGISTRO
LATERAL
BASECLIC
CPD.00509

FORA DE LINHA

GUARNIÇÃO
CÔNICA
CPD.02106
OBS: Kit com 12 pç.

FORA DE LINHA

VEDAÇÃO CASTELOS 1/2" E 3/4"

CPD.01109

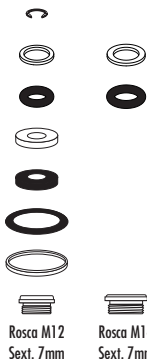

Rosca M12
Sext. 7mm

Rosca M14
Sext. 7mm

Rosca M14
Sext. 3/8"

VEDAÇÃO BICO MISTURADOR LAVATÓRIO

CPD.04006

FORA DE LINHA



Chave Allen 3/32"
(inclusa)

FLANGE 3/4"

CPD.00202



DETALHAMENTO DE REPAROS

TÊ CENTRAL MISTURADOR LAVATÓRIO

CPD.04031

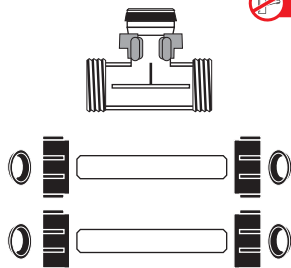

TÊ CENTRAL MISTURADOR LAVATÓRIO ANTIGO

CPD.00182

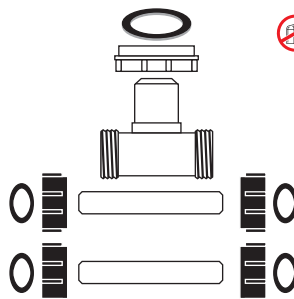

OBS: Para bases convencionais anteriores a set/2001, utilizar este Tê Central.

TUBO LIGAÇÃO MISTURADOR LAVATÓRIO

CPD.00014

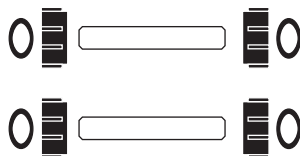

CRUZETA CENTRAL AJET

CPD.05062

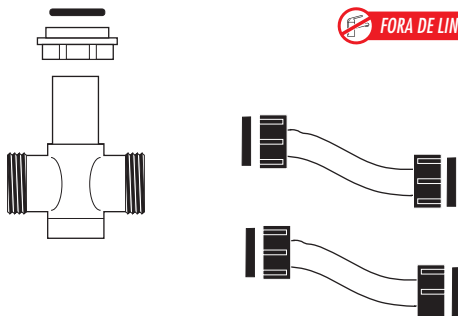

TÊ BASECLIC CURVO

CPD.04615

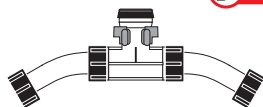

OBS: Para instalar a Baseclik em banca com furação em curva.



DETALHAMENTO DE REPAROS

CASTELO REGISTRO LATERAL ANTIGO

CPD.09006

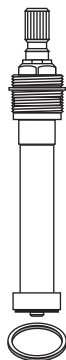

Usado até 1982

CASTELO REGISTRO LATERAL CONVENCIONAL

CPD.01090

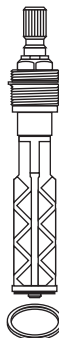

Obs.: Usado entre 1982 e 2001

SEDE REGISTRO LATERAL/CENTRAL

CPD.01184



Obs.: Usado entre 1982 e 2001

ACABAMENTO MISTURADOR LAVATÓRIO TUBO GOA

CR - CPD.07224

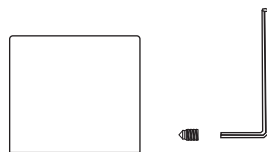

Chave Allen 3/32"
(inclusa)

BICOS

BICO OGGI

CR - CPD.00501

AREJADOR CURTO
T2 MACHO
CR - CPD.07225



FORA DE LINHA

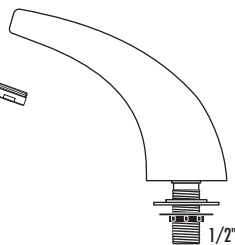

Obs.: Aquarius, Digital Line, Duello e Petra.

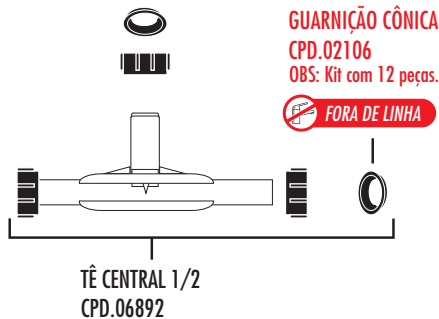

GUARNIÇÃO CÔNICA
CPD.02106
OBS: Kit com 12 peças.



FORA DE LINHA

BICO ASCOT

CR-CPD.03142



FORA DE LINHA

AREJADOR T2
MACHO
CR - CPD.07101

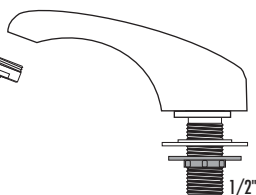

Obs: Lyon.

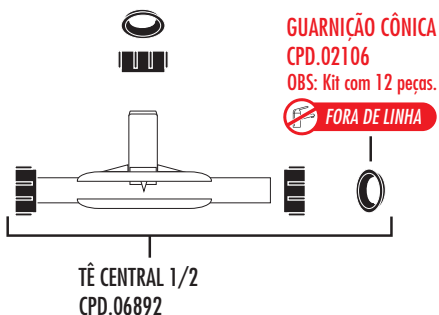

GUARNIÇÃO CÔNICA
CPD.02106
OBS: Kit com 12 peças.



FORA DE LINHA

BICO MISTY

CR - CPD.03144



FORA DE LINHA

AREJADOR T1
MACHO
CR - CPD.03085

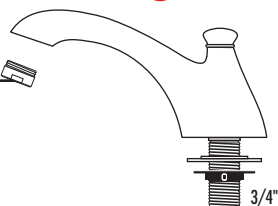

Opções de arejadores ver grupo 10.

TUBOS

TUBO MISTURADOR LAVATÓRIO BANCA OGGI

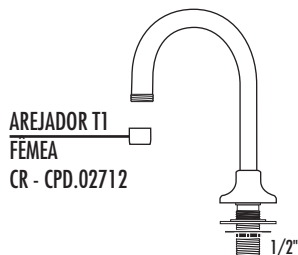

Obs: Ascot, Aquarius, Digital Line,
Lyon, Misty e Petra.

CR - CPD.03063

FORA DE LINHA

GUARNIÇÃO CÔNICA

CPD.02106

OBS: Kit com 12 peças.

FORA DE LINHA

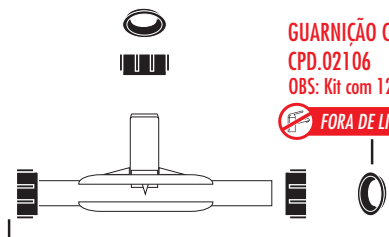

TÊ CENTRAL 1/2
CPD.06892

TUBO MISTURADOR LAVATÓRIO BANCA GYRO

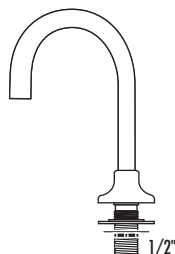

CR - CPD.06156

FORA DE LINHA

GUARNIÇÃO CÔNICA

CPD.02106

OBS: Kit com 12 peças.

FORA DE LINHA

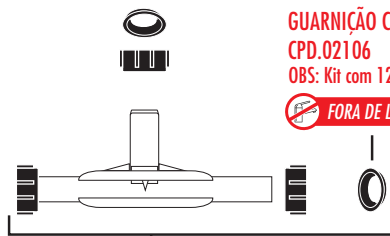

TÊ CENTRAL 1/2
CPD.06892

TUBO MISTURADOR LAVATÓRIO BANCA SOHO

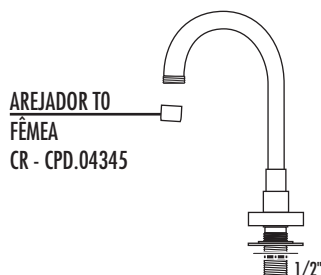

Obs: Chiara, Duello e Gioia.

CR - CPD.04298

FORA DE LINHA

GUARNIÇÃO CÔNICA

CPD.02106

OBS: Kit com 12 peças.

FORA DE LINHA

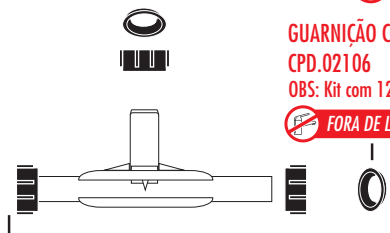

TÊ CENTRAL 1/2
CPD.06892

Opções de arejadores ver grupo 10.

TUBOS

TUBO MISTURADOR LAVATÓRIO BANCA FOLK

AREJADOR EMBUTIDO

M 16,5

CR - CPD.06409

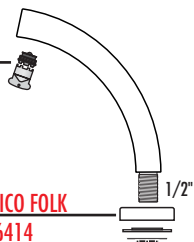

CANOPLA BICO FOLK

CR - CPD.06414



CR - CPD.06410



GUARNIÇÃO CÔNICA

CPD.02106

OBS: Kit com 12 peças.

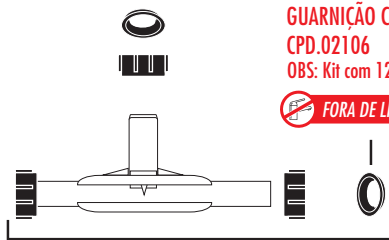

TÊ CENTRAL 1/2

CPD.06892

TUBO MISTURADOR LAVATÓRIO BANCA ZETA

AREJADOR EMBUTIDO

M 16,5

CR - CPD.06409

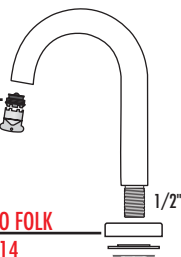

CANOPLA BICO FOLK

CR - CPD.06414



CR - CPD.06411



GUARNIÇÃO CÔNICA

CPD.02106

OBS: Kit com 12 peças.

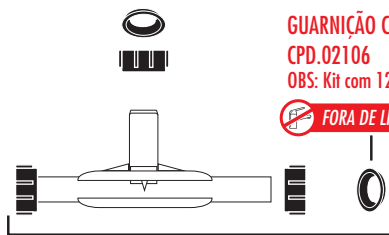

TÊ CENTRAL 1/2

CPD.06892

Obs: Utilizado também na linha Creato.

Opções de arejadores ver grupo 10.

TUBOS

TUBO MISTURADOR LAVATÓRIO BANCA LOFT

CR - CPD.03061

FORA DE LINHA

AREJADOR T1
FÊMEA
CR - CPD.02712

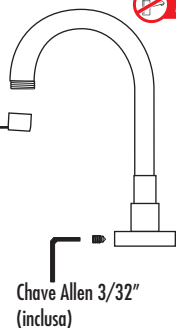

Obs: Design

Chave Allen 3/32"
(inclusa)

TUBO MISTURADOR LAVATÓRIO BANCA GOA

CR - CPD.07219

FORA DE LINHA

AREJADOR EMBUTIDO
RETANGULAR 28 x 7
CPD.07316

FORA DE LINHA

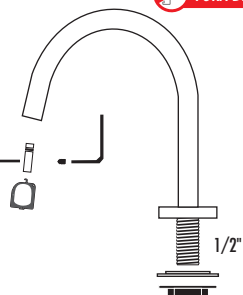

TUBO LAVATÓRIO BANCA SHIVA

CR-CPD.06124

FORA DE LINHA

AREJADOR EMBUTIDO
RETANGULAR 32 x 8
CPD.06110

FORA DE LINHA

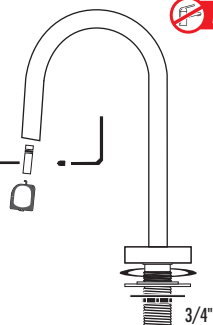

TUBO LAVATÓRIO BANCA VITRA

CR-CPD.06125

FORA DE LINHA

AREJADOR
EMBUTIDO M18,5
CPD.05333

FORA DE LINHA

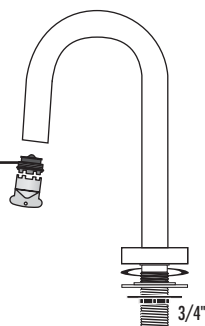

TUBO JOLIE

CR - CPD.03053

FORA DE LINHA

AREJADOR T2
FÊMEA
CR - CPD.07116

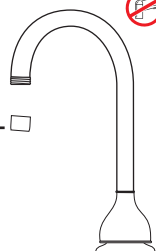
Chave Allen 3/32"
(inclusa)

Opções de arejadores ver grupo 10.

 LINHAS COM ACIONAMENTO 1/4 DE VOLTA

MECANISMO CERÂMICO 3/4"
FECHAMENTO HORÁRIO
CPD.02084

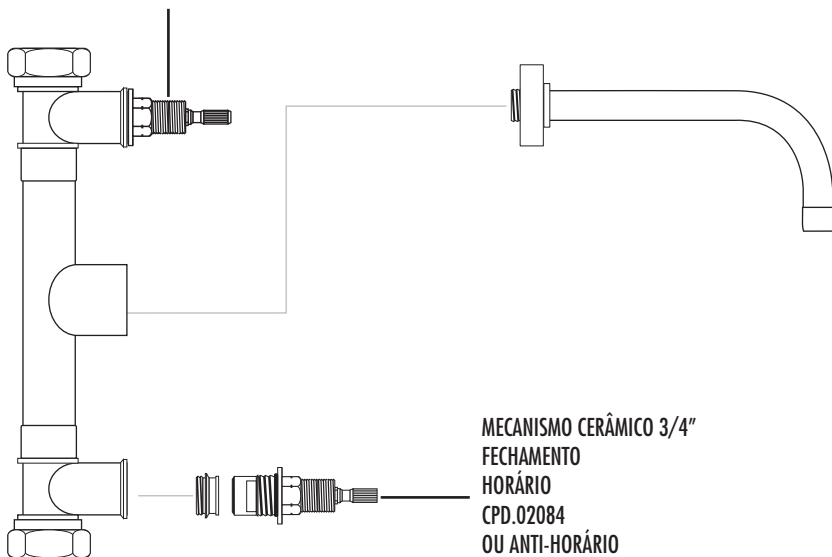

MECANISMO CERÂMICO 3/4"
FECHAMENTO
HORÁRIO
CPD.02084
OU ANTI-HORÁRIO
CPD.02060

Sede M22
Usar chave Allen 14 mm
(não inclusa)

 MECANISMO CERÂMICO 3/4" FECHAMENTO

ANTI-HORÁRIO

CPD.02060

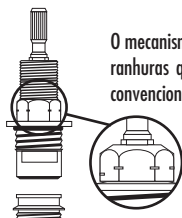

O mecanismo invertido vem com
ranhuras que o diferenciam do
convencional.

sede M22
usar chave Allen 14mm
(não inclusa)

LINHAS COM ACIONAMENTO 1/4 DE VOLTA AJUSTÁVEL

MECANISMO CERÂMICO 3/4"
FECHAMENTO HORÁRIO AJUSTÁVEL
CPD.06117

 FORA DE LINHA

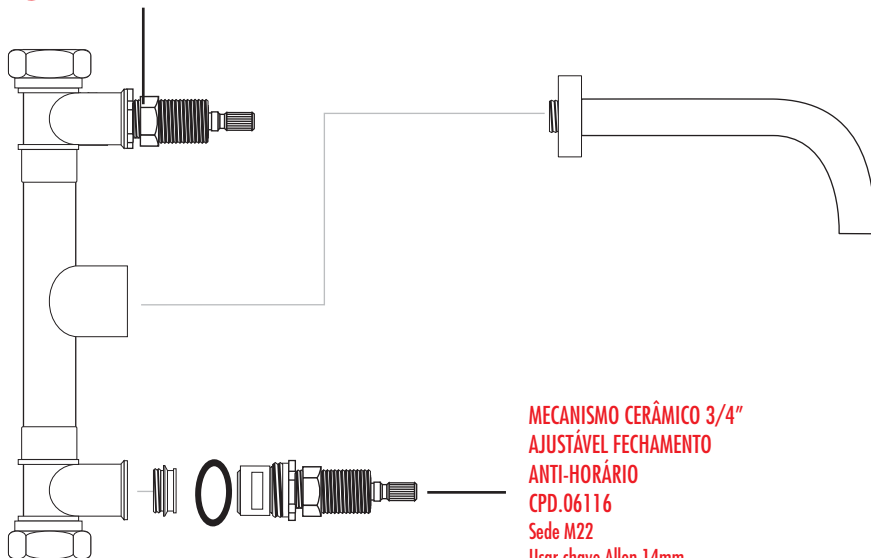

MECANISMO CERÂMICO 3/4"
AJUSTÁVEL FECHAMENTO
ANTI-HORÁRIO
CPD.06116

Sede M22
Usar chave Allen 14mm
(não inclusa)

 FORA DE LINHA

MECANISMO CERÂMICO 3/4" FECHAMENTO
ANTI-HORÁRIO AJUSTÁVEL

CPD.06116

 FORA DE LINHA

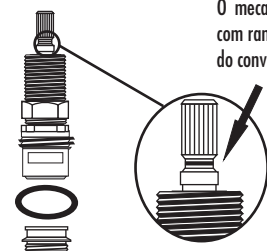

O mecanismo anti-horário vem com ranhuras que o diferenciam do convencional.

sede M22
usar chave Allen 14mm
(não inclusa)

Solução para inverter
o sentido de abertura
Obs.: Abre no sentido horário.

LINHAS COM ACIONAMENTO CONVENCIONAL

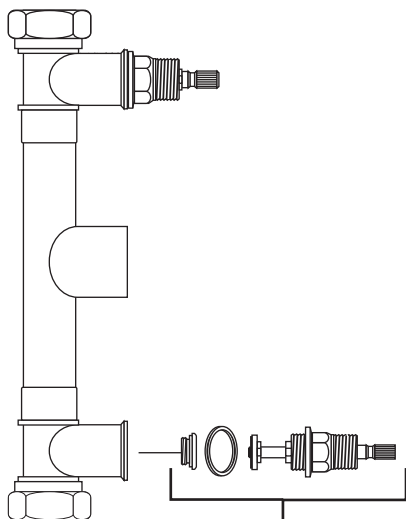

CASTELO REGISTRO
PRESSÃO 1/2" e 3/4"
CPD.02373

Sede M14
Usar chave Allen 3/8"
(não inclusa)

VEDAÇÃO CASTELOS 1/2", 3/4"

CPD.01109

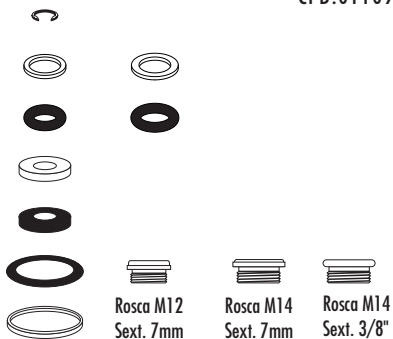

TUBOS

TUBO MISTURADOR LAVATÓRIO PAREDE LEVIER



AREJADOR T2
FÊMEA
CR - CPD.07116

CR - CPD.02623



TUBO MISTURADOR LAVATÓRIO PAREDE LOFT

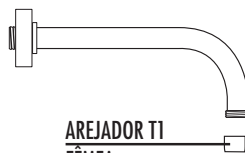

AREJADOR T1
FÊMEA
CR - CPD.02712

CR-CPD.02709



Obs.: Utilizado também nas linhas Duello, Chiara, Gioia e Soho.

TUBO MISTURADOR LAVATÓRIO PAREDE SHIVA

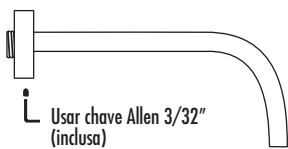

Usar chave Allen 3/32"
(inclusa)

AREJADOR EMBUTIDO
RETANGULAR 32 x 8
CPD.06110



CR-CPD.06139



Usar chave Allen 1,5mm
(inclusa)

TUBO MISTURADOR LAVATÓRIO PAREDE VITRA



Usar chave Allen 3/32"
(inclusa)

AREJADOR
EMBUTIDO M18,5
CPD.05333



CR-CPD. 06140



TUBO MISTURADOR LAVATÓRIO PAREDE FOLK

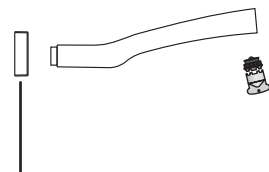

CANOPLA BICO FOLK
CR - CPD.06414



CR - CPD. 06412



AREJADOR EMBUTIDO

M 16,5
CR - CPD.06409



Obs.: Utilizado também nas linhas Creato e Zeta.

TUBO MISTURADOR LAVATÓRIO PAREDE GOA

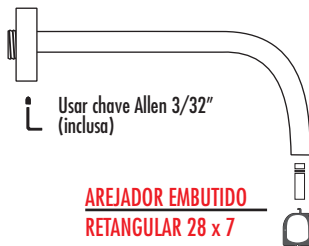

Usar chave Allen 3/32"
(inclusa)

AREJADOR EMBUTIDO
RETANGULAR 28 x 7
CPD.07316



CR - CPD. 07220

Usar chave Allen
1,5mm (inclusa)

ACABAMENTO
TORNEIRA GYRO
CPD. 05391

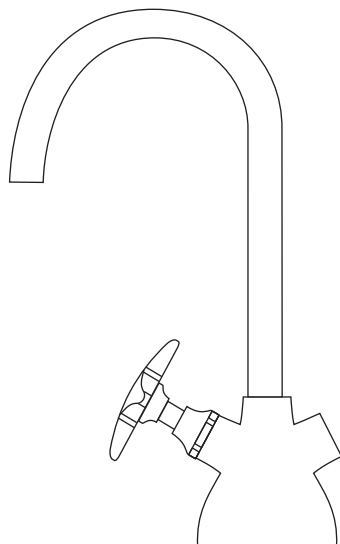
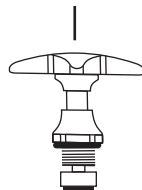

FIXAÇÃO MONOCOMANDO
CIVIC / CONCEPT
CPD. 04017

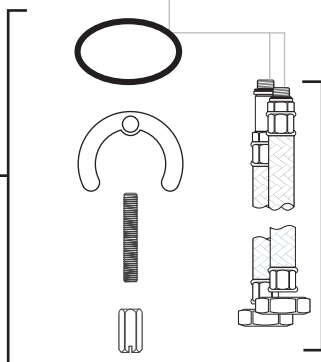

FLEXÍVEIS MONOCOMANDO
40 cm - CPD.03151
60 cm - CPD.03454
(par de flexíveis)

CARRAPETA GYRO

CPD.05393



OBS: ESTE REPARO É COMPATÍVEL COM
O MONOBLOCO DA LINHA EIXO.

LINHAS COM ACIONAMENTO CONVENCIONAL

REGISTRO CENTRAL BASECLIC

CPD.00511



FORA DE LINHA

DUCHA BIDÊ

CR - CPD.03978



FORA DE LINHA

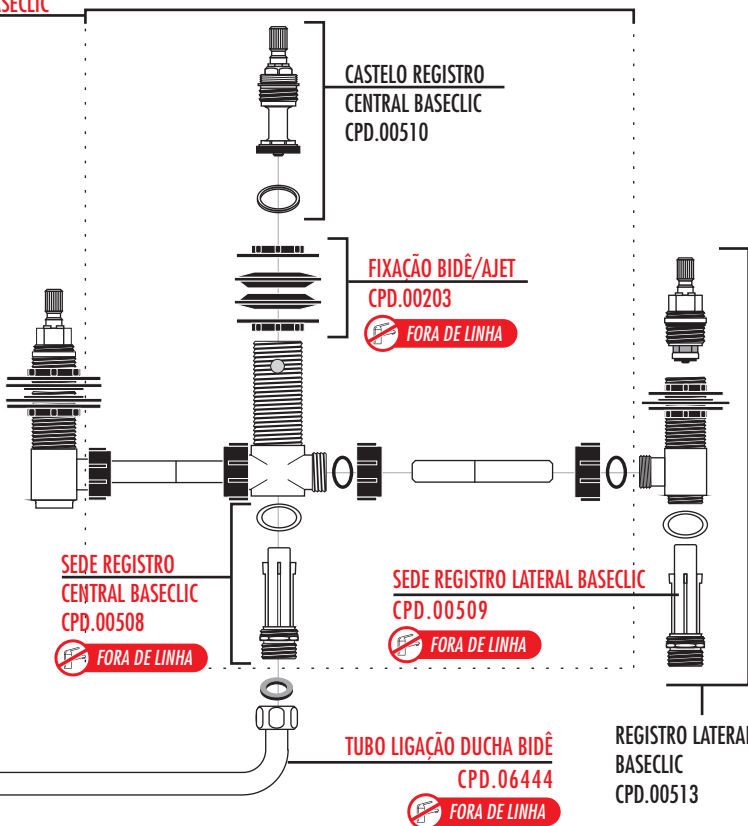
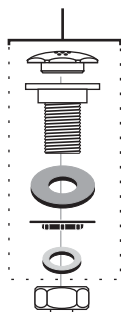

CASTELO REGISTRO LATERAL BASECLIC

CPD.00514



sede M12
usar chave Allen 7mm



sede M14 BV
usar chave Allen 7 mm
(não inclusa)

VEDAÇÃO CASTELOS 1/2", 3/4"

CPD.01109

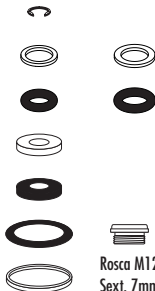

Rosca M12
Sext. 7mm

Rosca M14
Sext. 7mm

Rosca M14
Sext. 3/8"



Recursos especiais para casos específicos procure nas páginas de detalhamento dos reparos.

LINHAS COM ACIONAMENTO 1/4 DE VOLTA

REGISTRO CENTRAL BASECLIC
CPD.00511

FORA DE LINHA

DUCHA BIDÊ
CR - CPD.03978

FORA DE LINHA

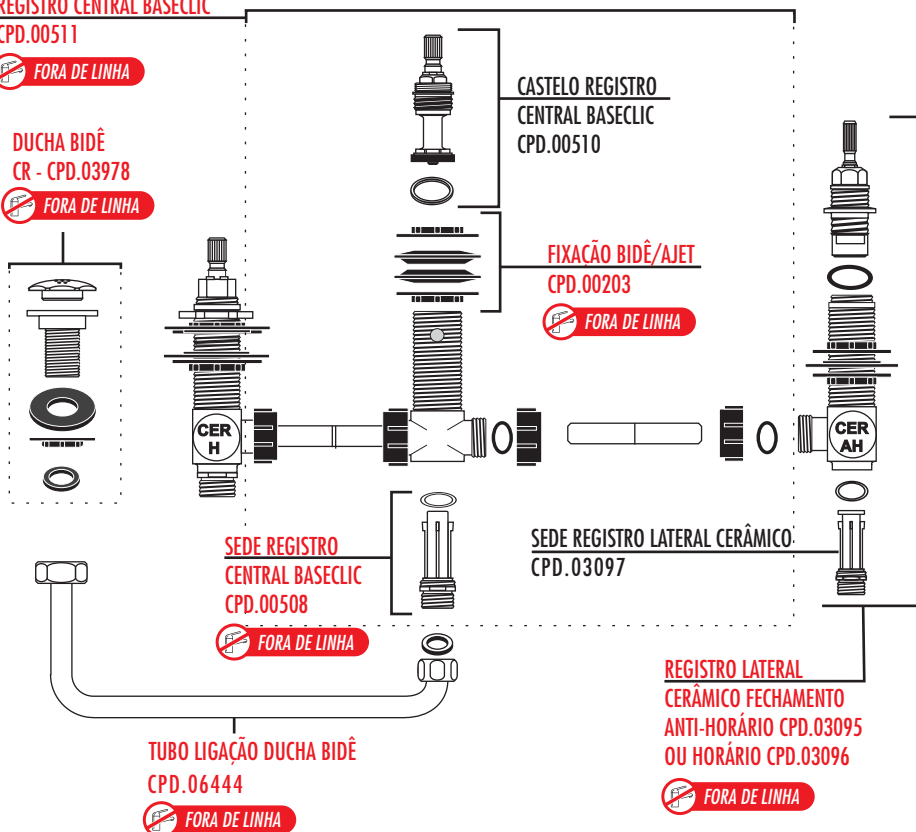

MECANISMO CERÂMICO 1/2" FECHAMENTO HORÁRIO

CPD.02102



MECANISMO CERÂMICO 1/2" FECHAMENTO ANTI-HORÁRIO

CPD.02101

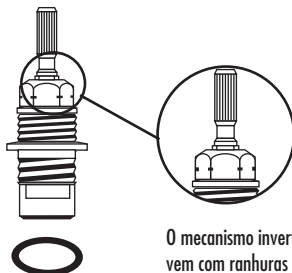

O mecanismo invertido vem com ranhuras que o diferenciam do convencional.



Recursos especiais para casos específicos procure nas páginas de detalhamento dos reparos.

LINHAS COM ACIONAMENTO 1/4 DE VOLTA AJUSTÁVEL

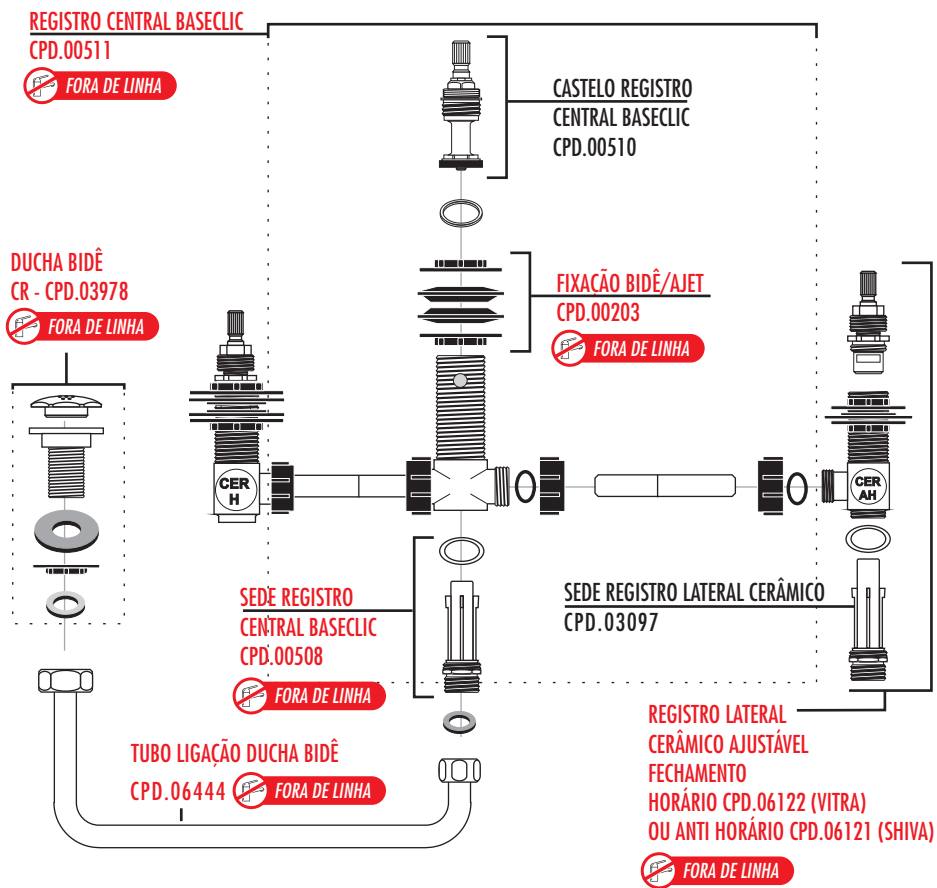

MECANISMO CERÂMICO 1/2" FECHAMENTO HORÁRIO AJUSTÁVEL
CPD.06115



MECANISMO CERÂMICO 1/2" FECHAMENTO ANTI-HORÁRIO AJUSTÁVEL
CPD.06114



O mecanismo invertido vem com ranhuras que o diferenciam do fechamento horário.



Recursos especiais para casos específicos procure nas páginas de detalhamento dos reparos.

DETALHAMENTO DE REPAROS

TUBO LIGAÇÃO LATERAL BIDÊ

CPD.00015



FORA DE LINHA

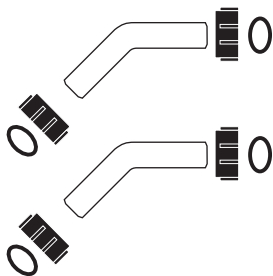

FLANGE 3/4"

CPD.00202



GUARNIÇÃO 1/2"

CPD.00179



OBS: Kit com 12 unidades

DETALHAMENTO DE REPAROS

CASTELO REGISTRO LATERAL CONVENCIONAL

CPD.01090

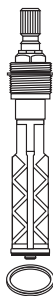

Usados entre 1982 e 2001

CASTELO REGISTRO CENTRAL CONVENCIONAL

CPD.01088



Usados entre 1982 e 2001

SEDE REGISTRO LATERAL / CENTRAL

CPD.01184



Usados entre 1982 e 2001

CASTELO REGISTRO LATERAL ANTIGO

CPD.09006



Obs.: Não há reparo
para este castelo.
Deve ser substituído
por novo

Usados até 1982

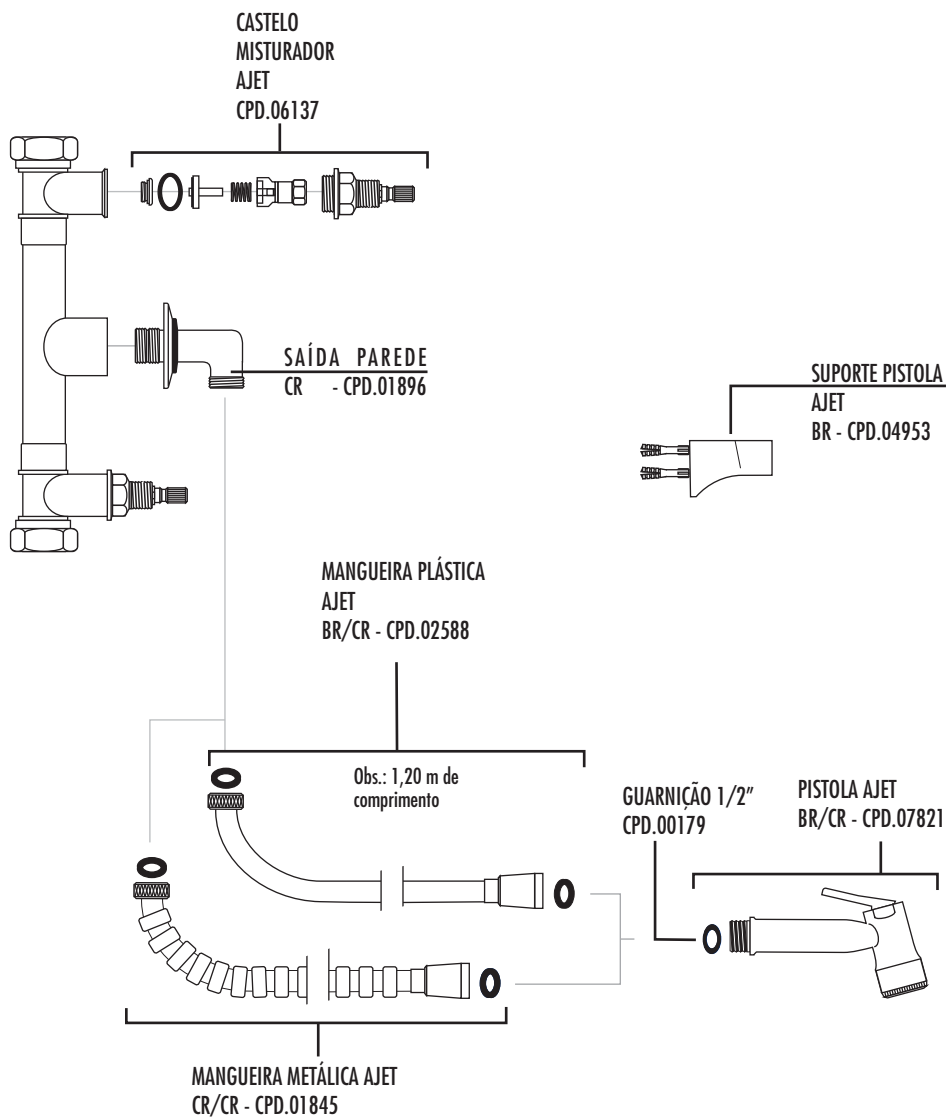

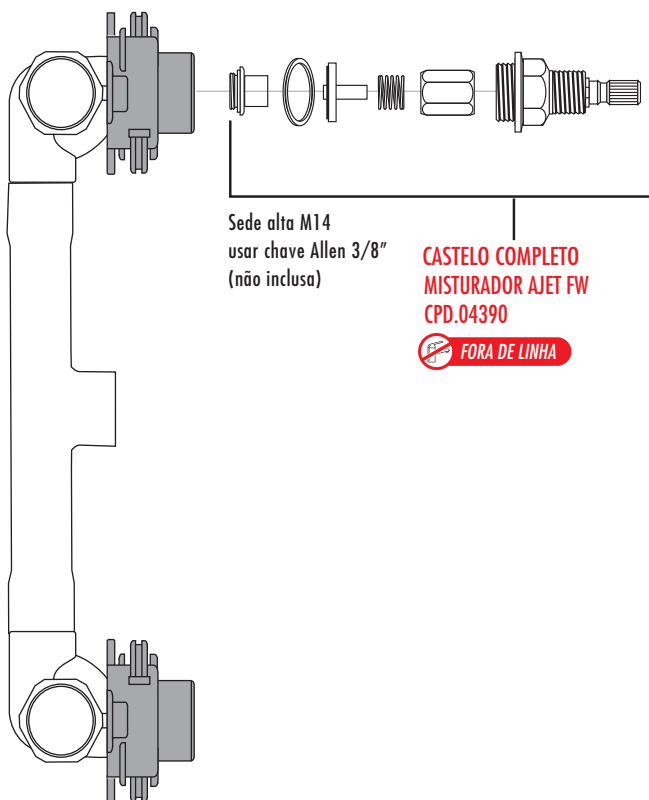

 LINHAS COM ACIONAMENTO 1/4 DE VOLTA

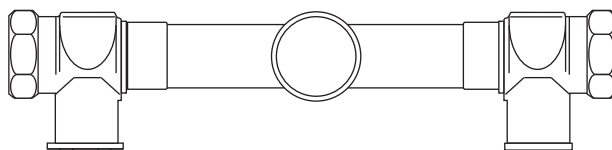

MECANISMO CERÂMICO
 3/4" FECHAMENTO
 HORÁRIO
 CPD.02084
 OU ANTI-HORÁRIO
 CPD 02060
 sede M22
 usar chave Allen 14mm
 (não inclusa)



MECANISMO CERÂMICO 3/4"
FECHAMENTO HORÁRIO
 CPD.02084
 sede M22
 usar chave Allen 14mm
 (não inclusa)

MECANISMO CERÂMICO 3/4" FECHAMENTO
ANTI-HORÁRIO CPD.02060

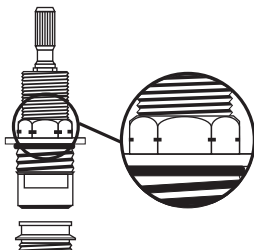

sede M22
 usar chave Allen 14mm
 (não inclusa)

LINHAS COM ACIONAMENTO 1/4 DE VOLTA AJUSTÁVEL

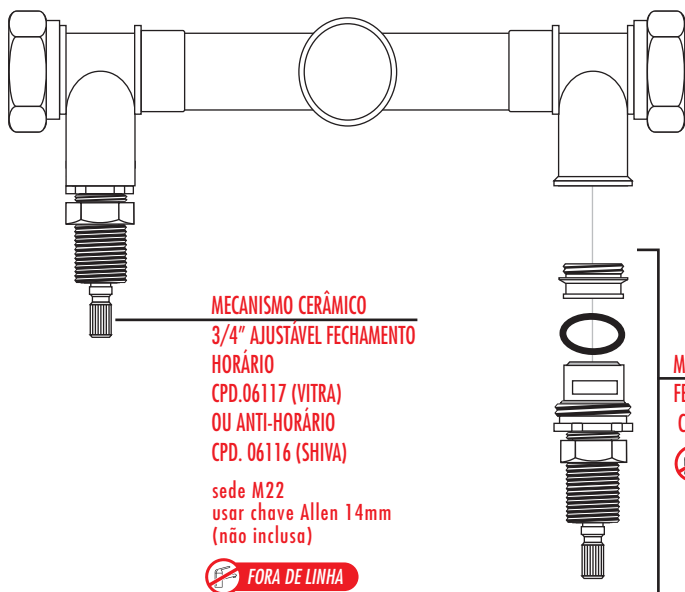

MECANISMO CERÂMICO
 3/4" AJUSTÁVEL FECHAMENTO
 HORÁRIO
 CPD.06117 (VITRA)
 OU ANTI-HORÁRIO
 CPD. 06116 (SHIVA)

sede M22
 usar chave Allen 14mm
 (não inclusa)

FORA DE LINHA

MECANISMO CERÂMICO 3/4"
FECHAMENTO HORÁRIO AJUSTÁVEL
 CPD.06117

FORA DE LINHA

MECANISMO CERÂMICO 3/4" FECHAMENTO
ANTI-HORÁRIO AJUSTÁVEL CPD.06116

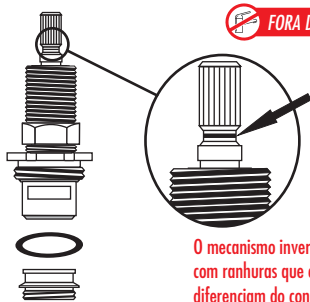

O mecanismo invertido vem
 com ranhuras que o
 diferenciam do convencional.

sede M22
 usar chave Allen 14mm
 (não inclusa)

LINHAS COM ACIONAMENTO CONVENCIONAL

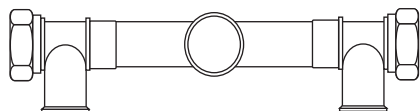

CASTELO REGISTRO
DE PRESSÃO 1/2" E 3/4"
CPD.02373
 sede M14
 usar chave Allen 3/8"
 (não inclusa)

PARA PAREDE DRYWALL

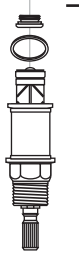
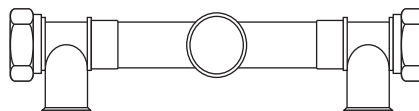

CASTELO REGISTRO
DE PRESSÃO 1/2" E 3/4"
LONGO
CPD.03344
 sede M14
 usar chave Allen 3/8"
 (não inclusa)

VEDAÇÃO CASTELOS 1/2", 3/4"

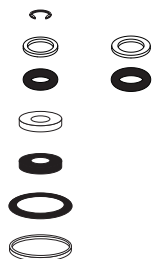

CPD.01109

		
Rosca M12 Sext. 7mm	Rosca M14 Sext. 7mm	Rosca M14 Sext. 3/8"

LINHAS COM ACIONAMENTO CONVENCIONAL FABRIWALL

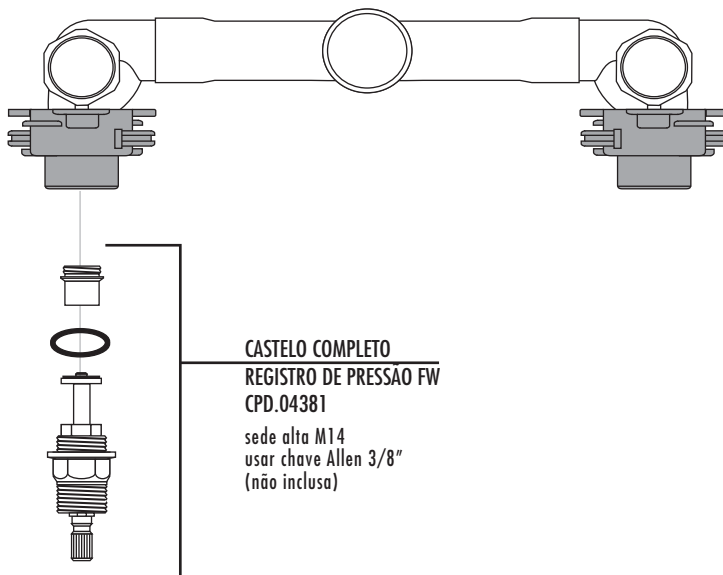

VEDAÇÃO CASTELOS 1/2", 3/4"

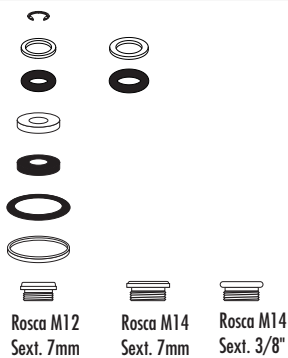

CPD.01109

LINHAS COM ACIONAMENTO 1/4 DE VOLTA
TERCEIRO VOLANTE

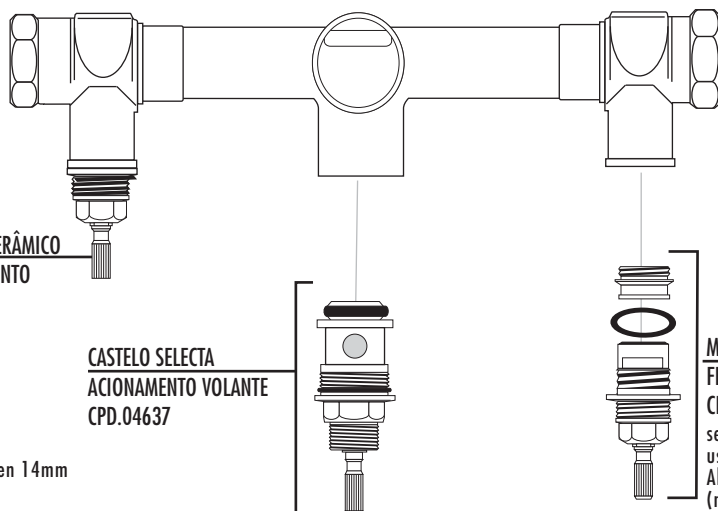
**MECANISMO CERÂMICO**

3/4" FECHAMENTO

HORÁRIO

CPD.02084

OU

ANTI-HORÁRIO

CPD.02060

sede M22

usar chave Allen 14mm

(não inclusa)

CASTELO SELECTA

ACIONAMENTO VOLANTE

CPD.04637

MECANISMO CERÂMICO 3/4"

FECHAMENTO HORÁRIO

CPD.02084

sede M22

usar chave

Allen 14mm

(não inclusa)

MECANISMO CERÂMICO 3/4" FECHAMENTO

ANTI-HORÁRIO

CPD.02060

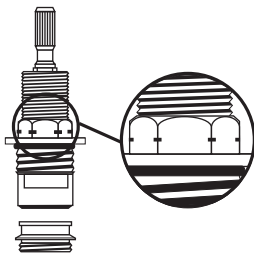

sede M22

usar chave Allen 14mm

(não inclusa)

LINHAS COM ACIONAMENTO 1/4 DE VOLTA AJUSTÁVEL
TERCEIRO VOLANTE

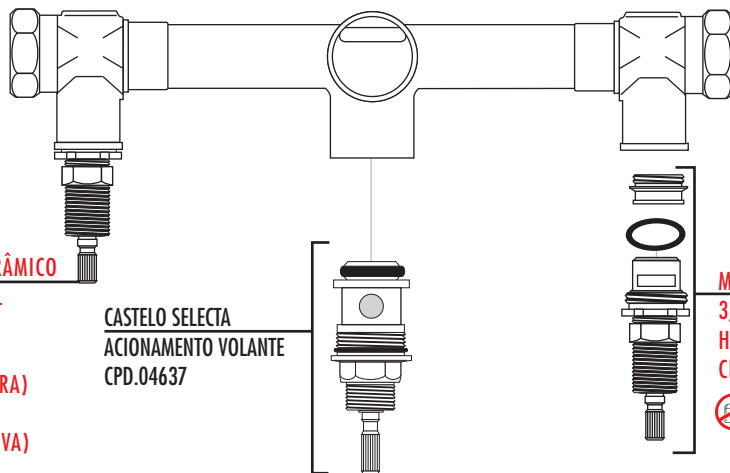

MECANISMO CERÂMICO
3/4" AJUSTÁVEL
FECHAMENTO
HORÁRIO
CPD.06117 (VITRA)
ANTI-HORÁRIO
CPD.06116 (SHIVA)

sede M22
usar chave
Allen 14mm
(não inclusa)

 FORA DE LINHA

MECANISMO CERÂMICO
3/4" FECHAMENTO
HORÁRIO AJUSTÁVEL
CPD.06117

 FORA DE LINHA

MECANISMO CERÂMICO 3/4" FECHAMENTO
ANTI-HORÁRIO CPD.02060

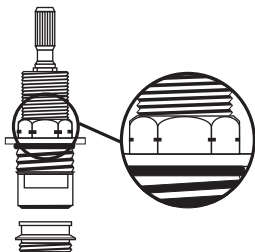

sede M22
usar chave Allen 14mm
(não inclusa)

**LINHAS COM ACIONAMENTO CONVENCIONAL FABRIWALL
BOTÃO DESVIADOR OU TERCEIRO VOLANTE**

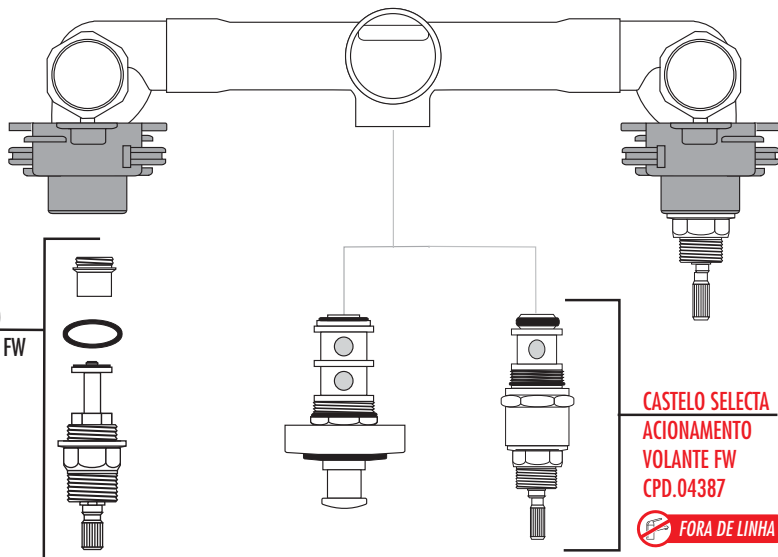

CASTELO COMPLETO
REGISTRO PRESSÃO FW
CPD.04381

sede alta M14
usar chave
Allen 3/8"
(não inclusa)

CASTELO SELECTA
ACIONAMENTO
VOLANTE FW
CPD.04387

FORA DE LINHA

CASTELO SELECTA

CR/CR - CPD.09002

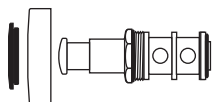

Usado a partir de abril 2002,
compatível com a base antiga

BOTÃO SELECTA

CR - CPD.07352



Atende aos dois modelos de mecanismo Selecta

CANOPLA SELECTA

CR - CPD.01094



LINHA PRATIKA

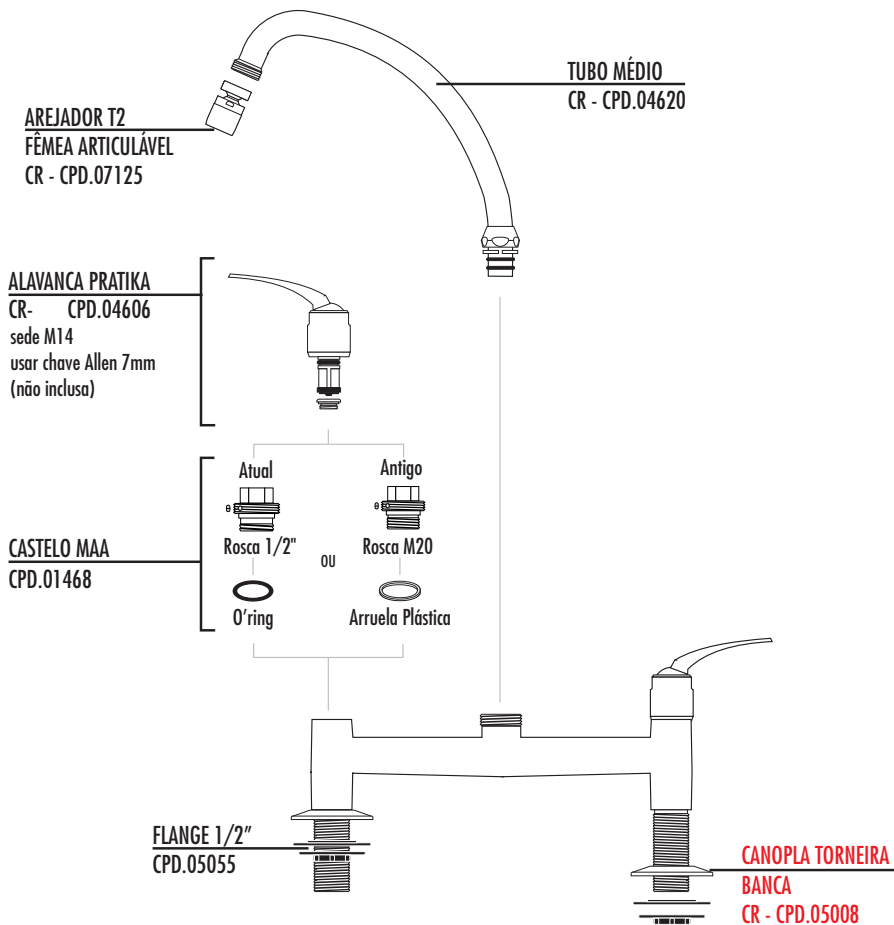

FORA DE LINHA

VEDAÇÃO TORNEIRA PRATIKA

CPD.09312



Rosca M12
Sext. 7mm

Rosca M14
Sext. 7mm



Recursos especiais para casos específicos procure nas páginas de detalhamento dos reparos.

LINHAS COM ACIONAMENTO 1/4 DE VOLTA

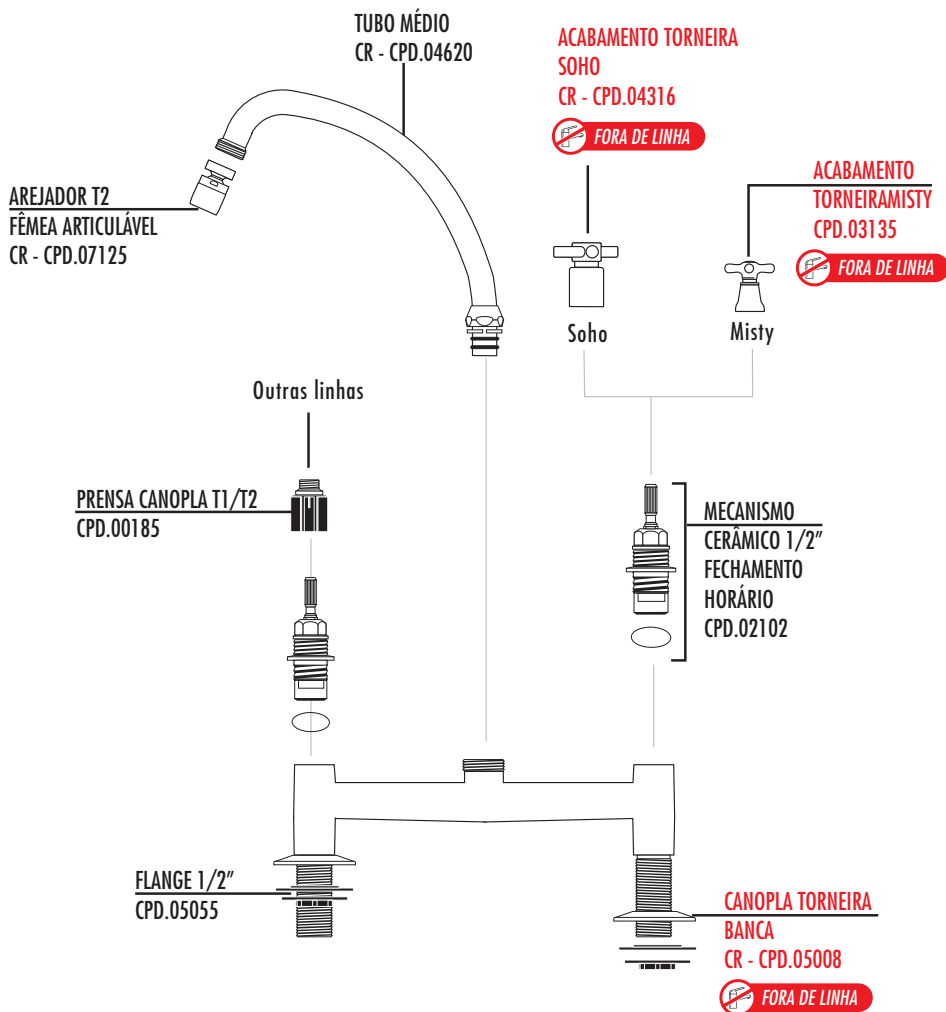

Recursos especiais para casos específicos procure nas páginas de detalhamento dos reparos.

LINHAS COM ACIONAMENTO CONVENCIONAL

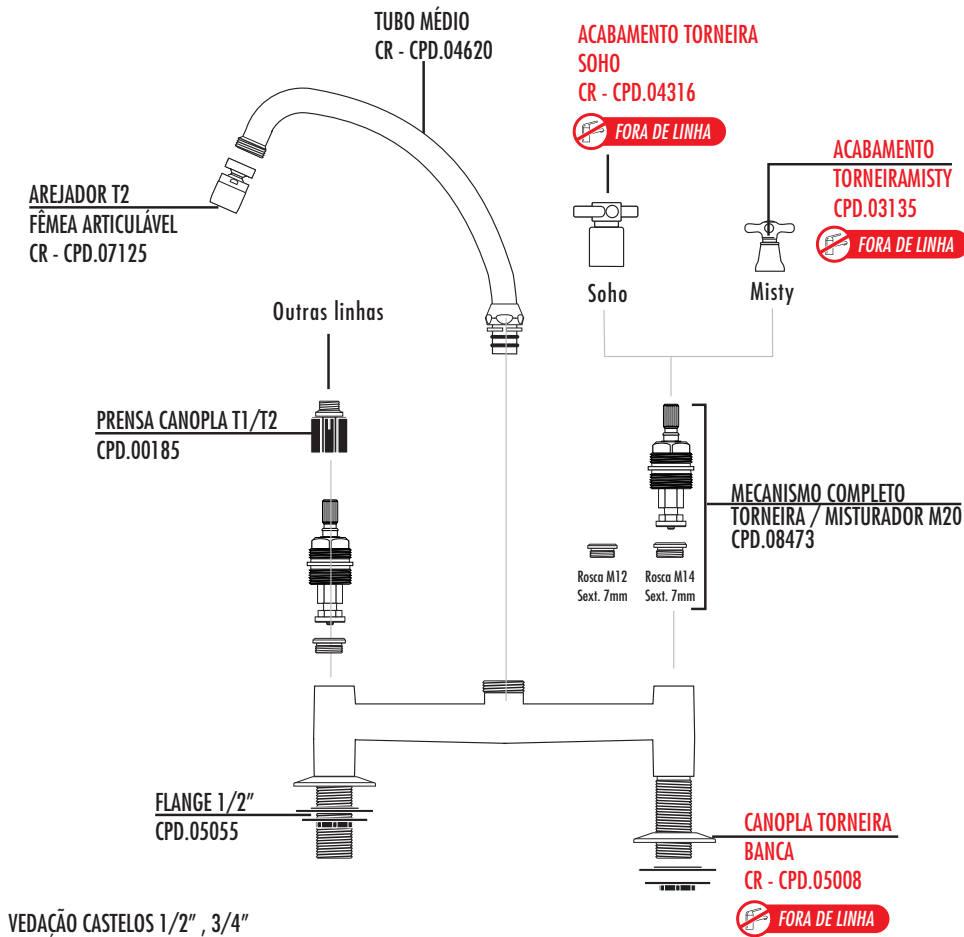

VEDAÇÃO CASTELOS 1/2", 3/4"

CPD.01109

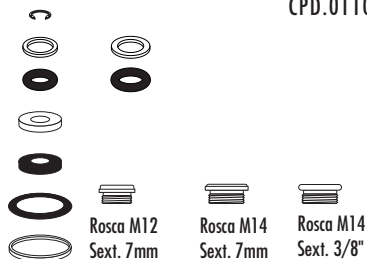

Recursos especiais para casos específicos procure nas páginas de detalhamento dos reparos.

LINHAS COM ACIONAMENTO LINEAR E CORPO ROSCA INTERNA

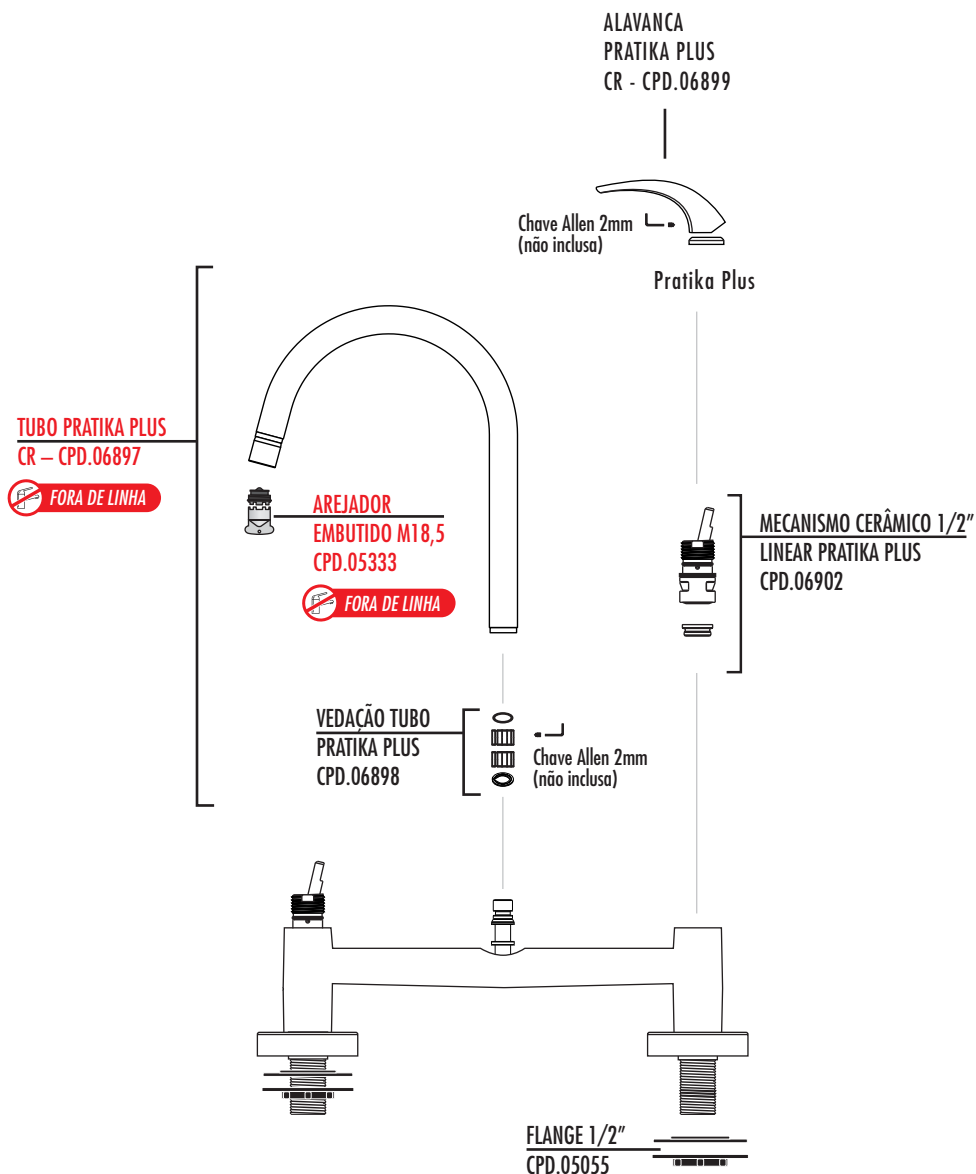

LINHAS COM ACIONAMENTO 1/4 DE VOLTA E CORPO ROSCA INTERNA

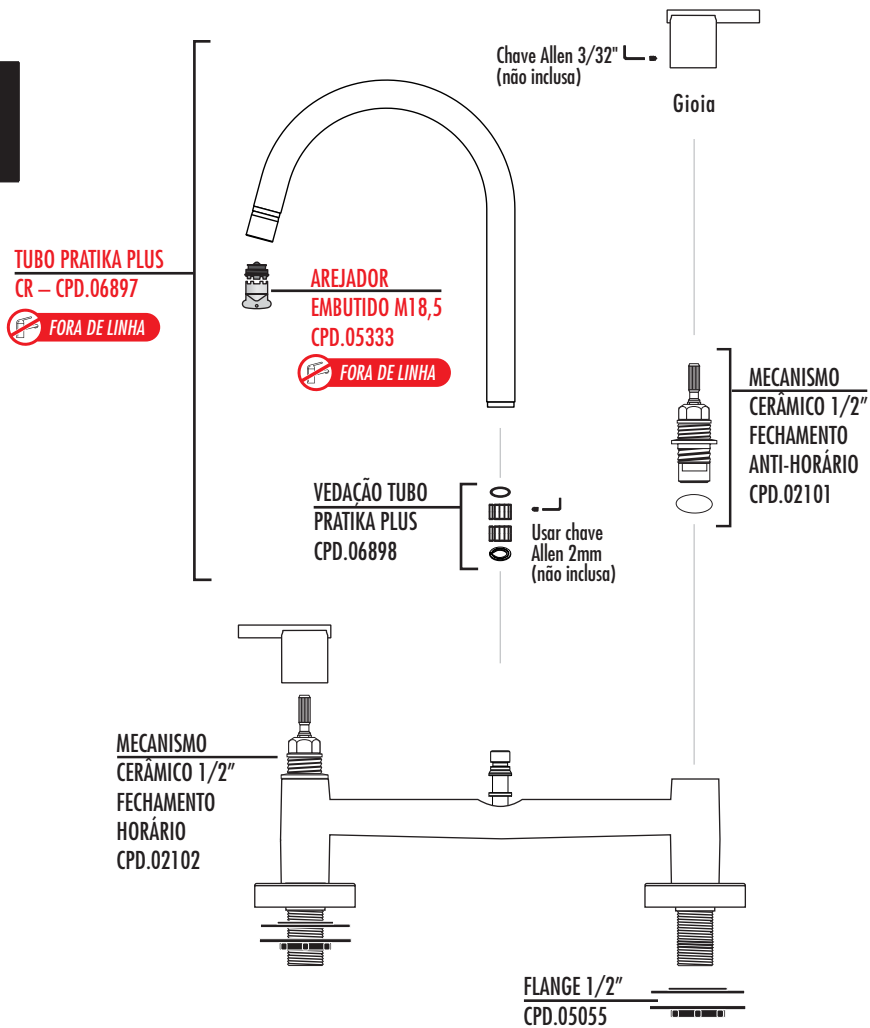

**LINHAS COM ACIONAMENTO CONVENCIONAL (CARRAPETA)
E CORPO LIGH**

TUBO COZINHA GYRO
CR - CPD.05395

 FORA DE LINHA

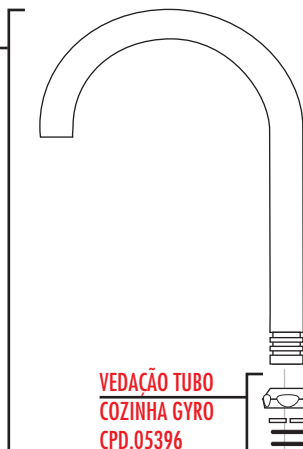

VEDAÇÃO TUBO
COZINHA GYRO
CPD.05396

 FORA DE LINHA

ACABAMENTO
TORNEIRA GYRO
CPD. 05391

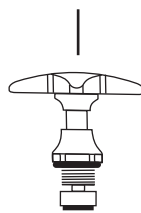

CORPO LIGHT

FLANGE 1/2"
CPD.05055

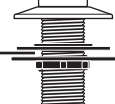

CANOPLA TORNEIRA
MISTURADOR BANCA
CR - CPD.05008

 FORA DE LINHA

CARRAPETA GYRO

CPD.05393

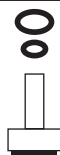

**CANOPLA TORNEIRA PAREDE
PRATIKA PLUS
CR - CPD.06903**

OBS: Utilizada nas linhas
Pratika Pluse e Gioia.

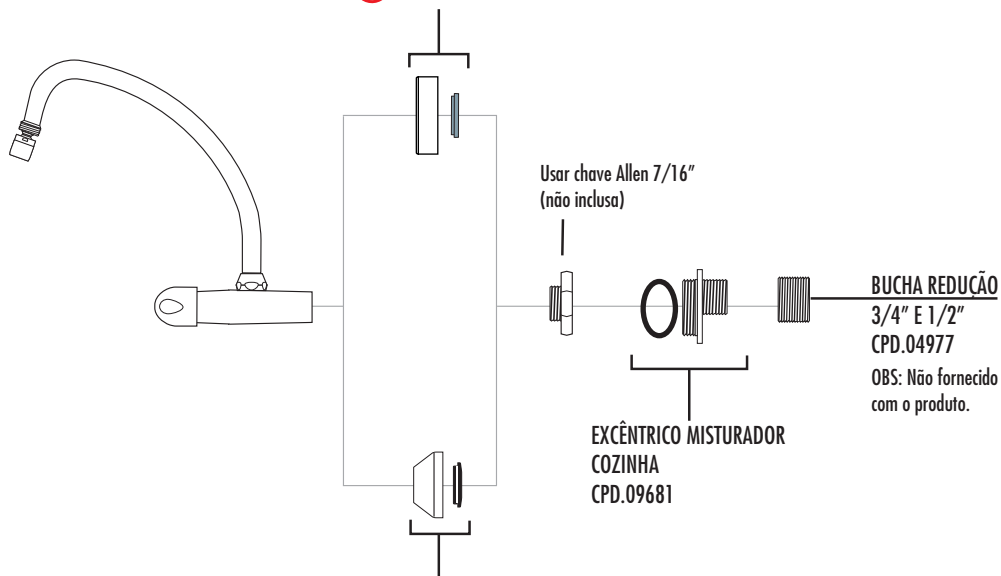

Usar chave Allen 7/16"
(não inclusa)

**BUCHA REDUÇÃO
3/4" E 1/2"
CPD.04977**

OBS: Não fornecido
com o produto.

**EXCÊNTRICO MISTURADOR
COZINHA
CPD.09681**

**CANOPLA TORNEIRA/
MISTURADOR PAREDE
CR - CPD.05040**

OBS: Utilizada nas demais linhas



Os misturadores de parede se adaptam as mesmas linhas das torneiras de banca e recebem os mesmos reparos para as de banca, com exceção dos reparos mostrados nas imagens acima.



Recursos especiais para casos específicos procure nas páginas de detalhamento dos reparos.

DETALHAMENTO DE REPAROS

TUBO LONGO

CR - CPD.04621

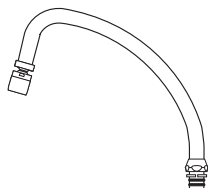

BICA LONGA

CR - CPD.04619

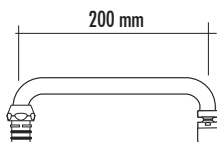

TUBO CURTO

CR - CPD.03153

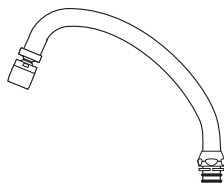

UNIÃO TUBO BICA ANTIGA

CR - CPD.01518

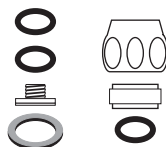

mais antiga

antiga

VEDAÇÃO TUBO BICA DE COZINHA

CPD.04622



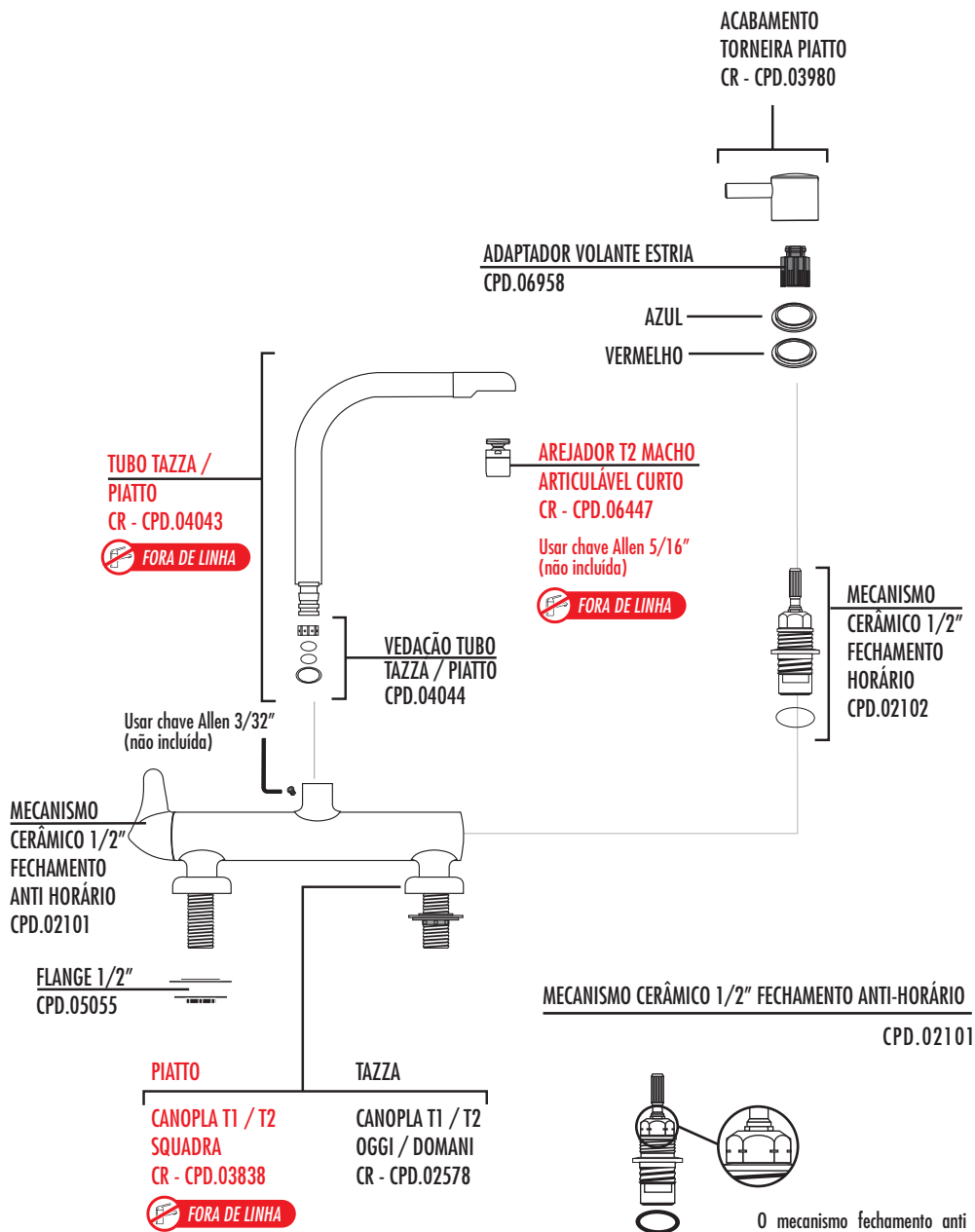

O mecanismo fechamento anti horário vem com ranhuras que o diferencia do fechamento horário.

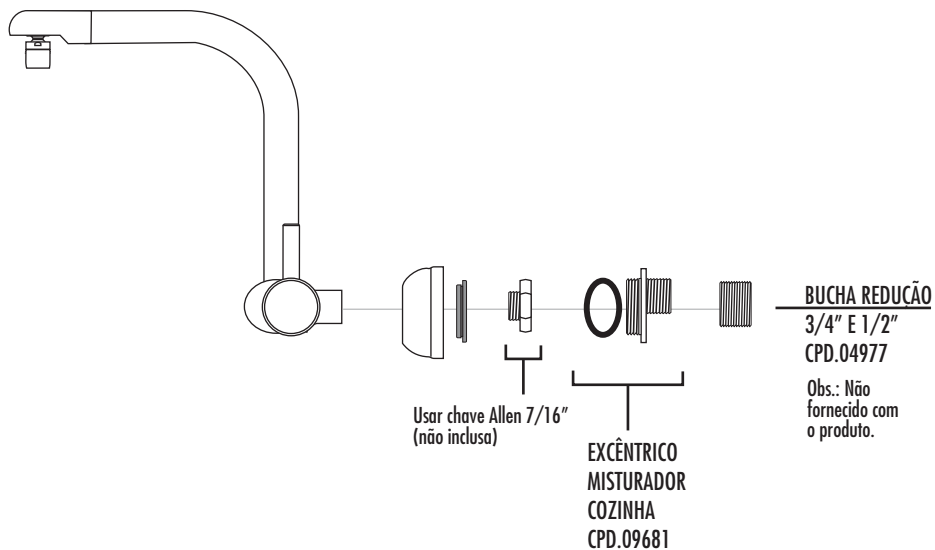

Os misturadores de parede se adaptam as mesmas linhas das torneiras de banca e recebem os mesmos reparos para as de banca, com exceção dos reparos acima.

ACABAMENTO
TORNEIRA PIATTO
CR - CPD.03980

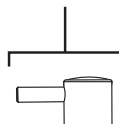

ADAPTADOR VOLANTE ESTRIA
CPD.06958



AZUL



VERMELHO



TUBO TAZZA /
PIATTO
CR - CPD.04043

FORA DE LINHA

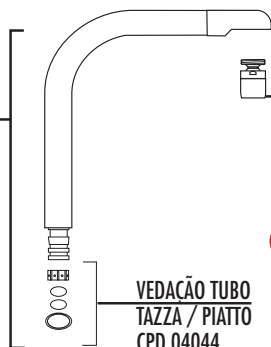

VEDAÇÃO TUBO
TAZZA / PIATTO
CPD.04044

AREJADOR T2 MACHO
ARTICULÁVEL CURTO
CR - CPD.06447

Usar chave Allen 5/16"
(não incluída)

FORA DE LINHA



MECANISMO
CERÂMICO 1/2"
FECHAMENTO
HORÁRIO
CPD.02102



Usar chave Allen 3/32"
(não incluída)

MECANISMO CERÂMICO 1/2"
FECHAMENTO ANTI HORÁRIO
CPD.02101

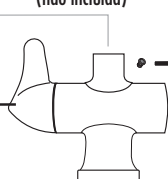

MECANISMO CERÂMICO 1/2" FECHAMENTO ANTI-HORÁRIO

CPD.02101

FIXAÇÃO
MONOCOMANDO
CIVIC / CONCEPT
CPD.04017

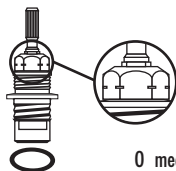

O mecanismo fechamento anti horário vem com ranhuras que o diferencia do fechamento horário.

FLEXÍVEIS
MONOCOMANDO
40 cm - CPD.03151
60 cm - CPD.03454
(Par de flexíveis)

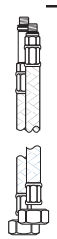

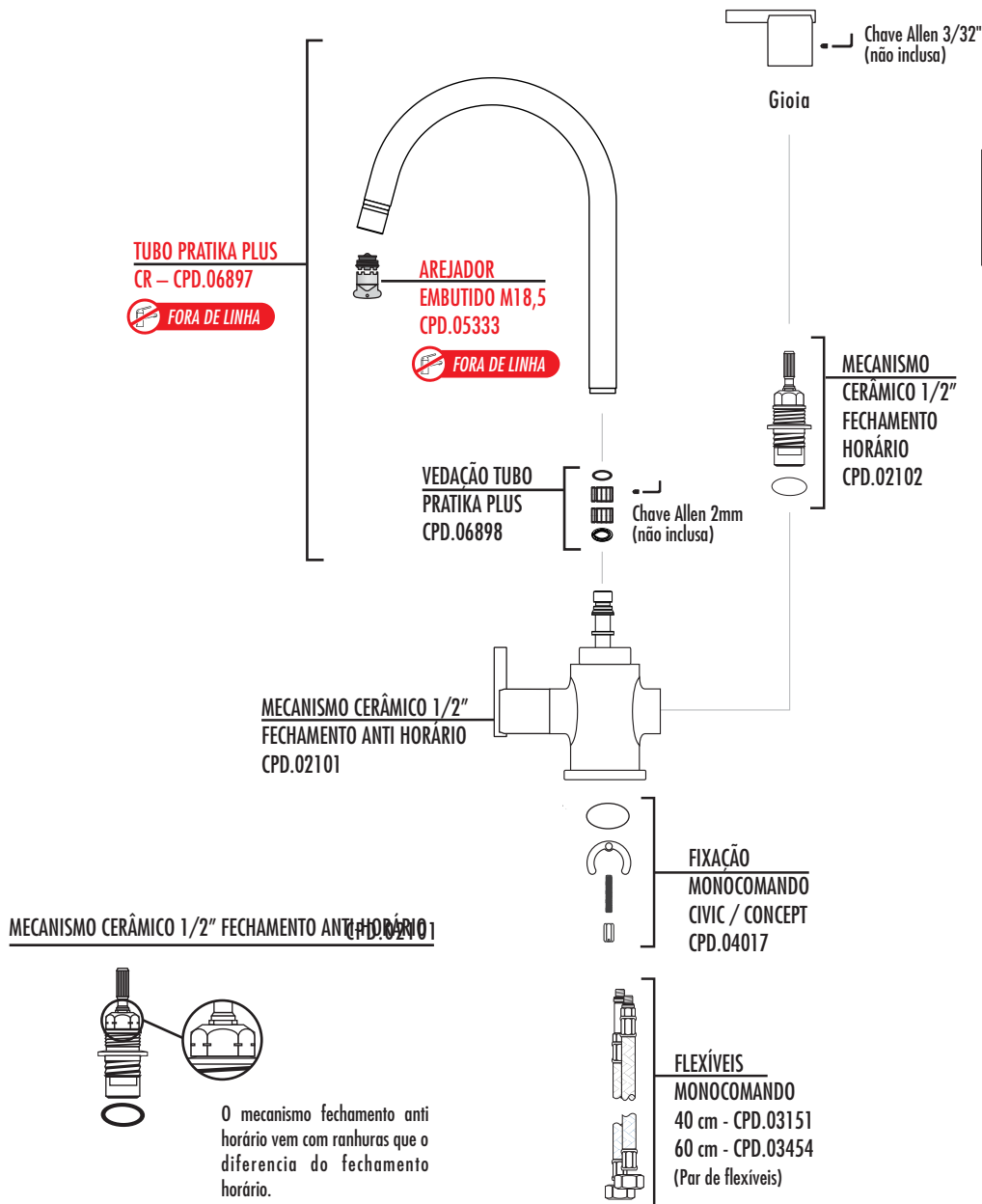

TUBO COZINHA
GYRO
CR - CPD.05395

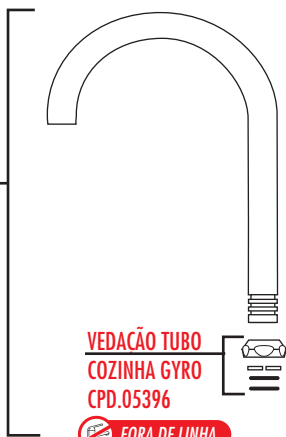

VEDAÇÃO TUBO
COZINHA GYRO
CPD.05396



ACABAMENTO
TORNEIRA GYRO
CPD. 05391

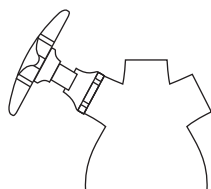
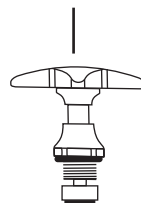

FIXAÇÃO MONOCOMANDO
CIVIC / CONCEPT
CPD. 04017

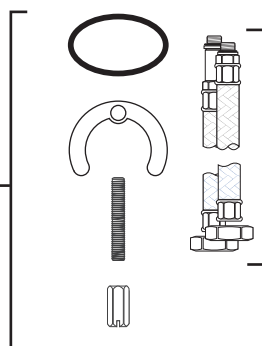

FLEXÍVEIS MONOCOMANDO
40 cm - CPD.03151
60 cm - CPD.03454
(par de flexíveis)

CARRAPETA GYRO

CPD.05393



Fora de linha

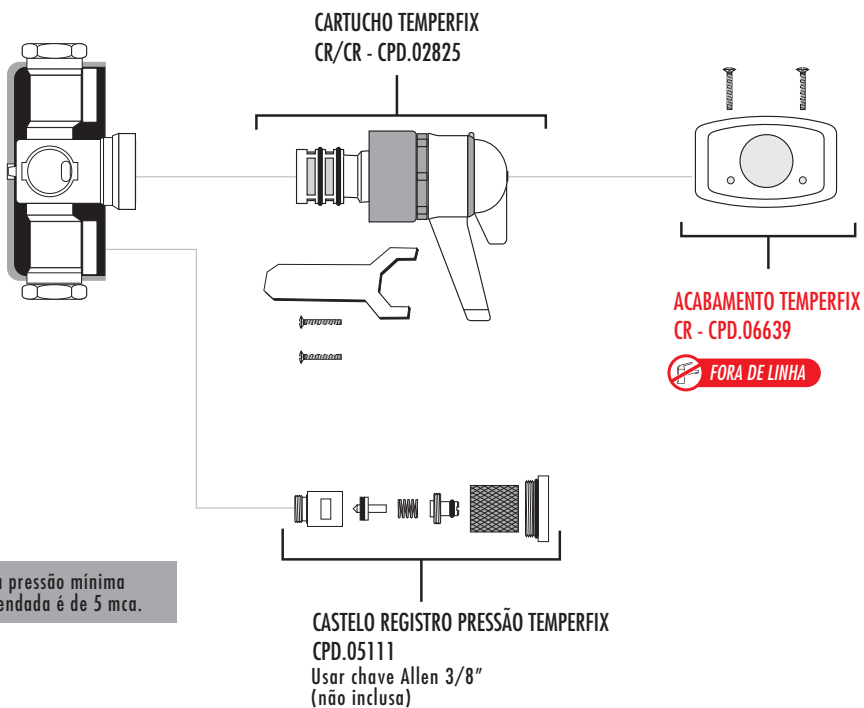

Acabamentos: tabela de produtos

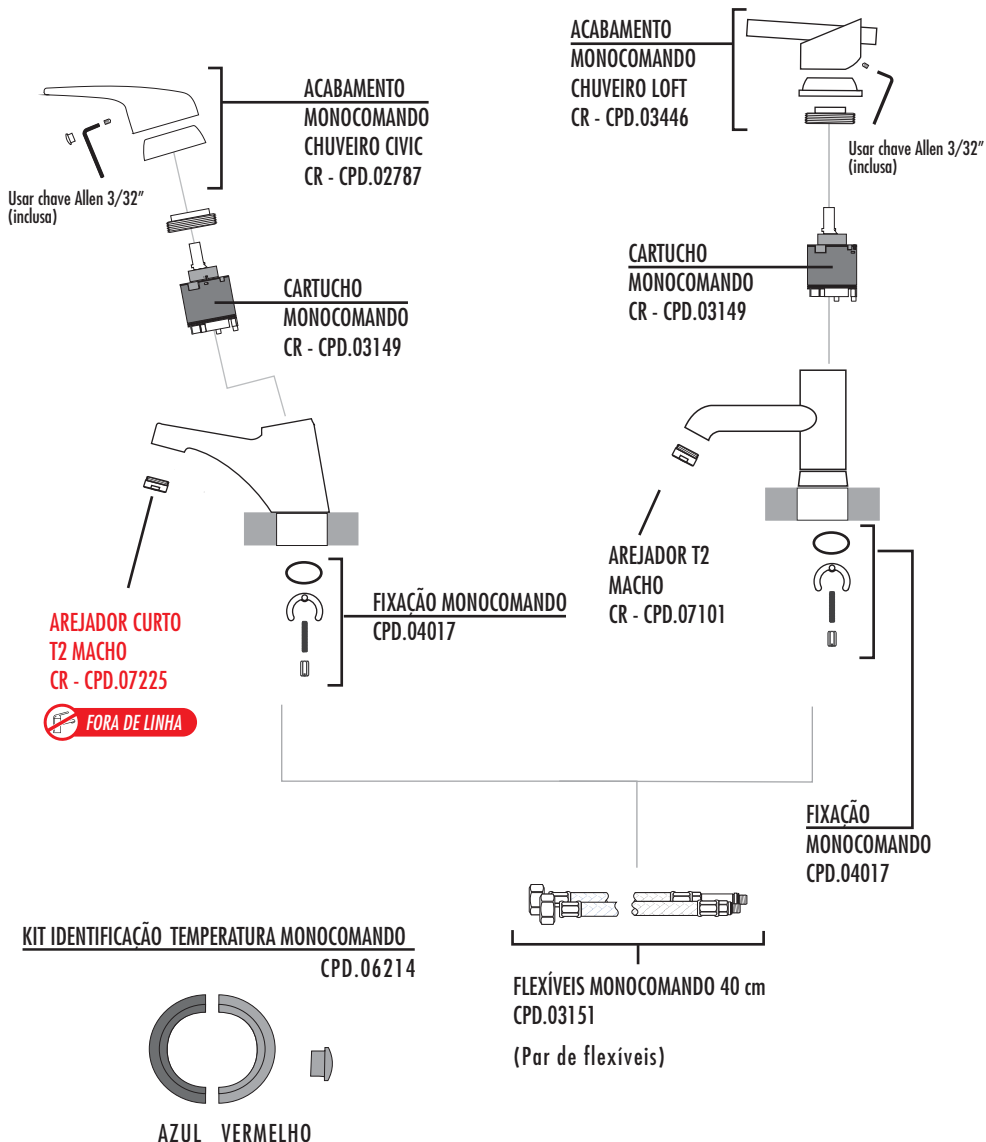

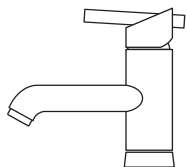

ref. 2875

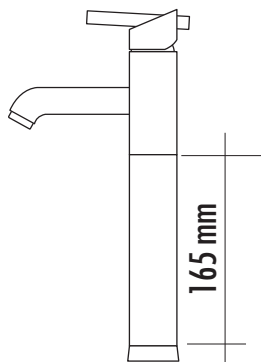

ref. 2877

Os monocomandos Loft possuem duas versões para lavatório, com alturas diferentes. Os sobressalentes apresentados na página anterior são os mesmos para os dois modelos, exceto os flexíveis, que para o modelo ref. 2877 são vistos abaixo:

FLEXÍVEIS MONOCOMANDO 60 cm

CPD.03454

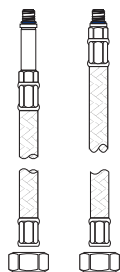

(Par de flexíveis)

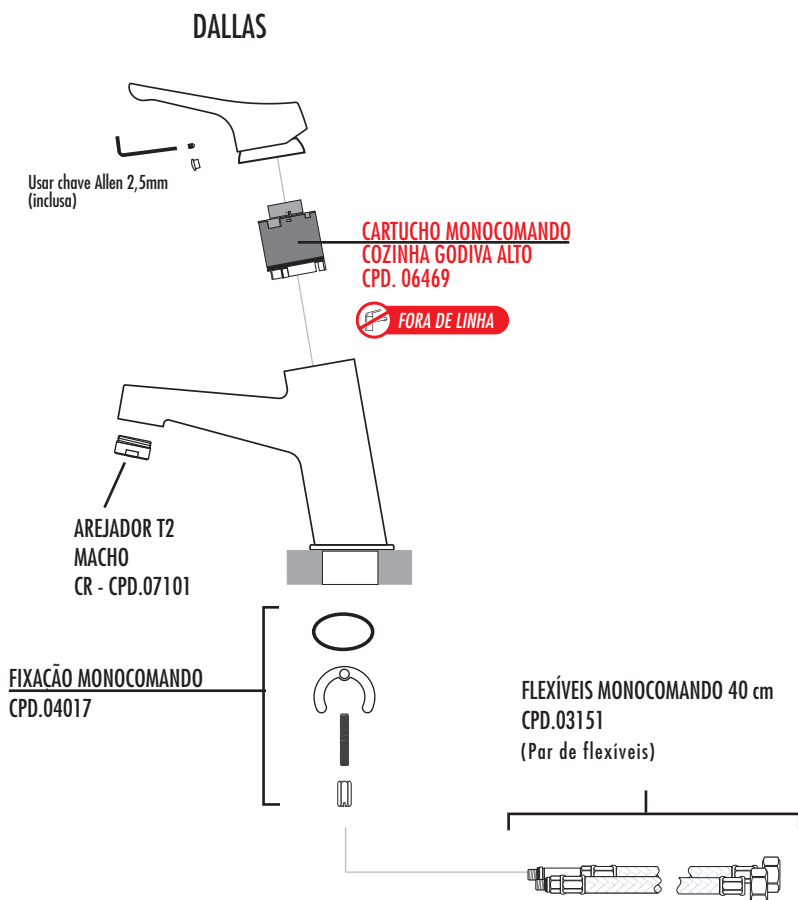

PAOLA

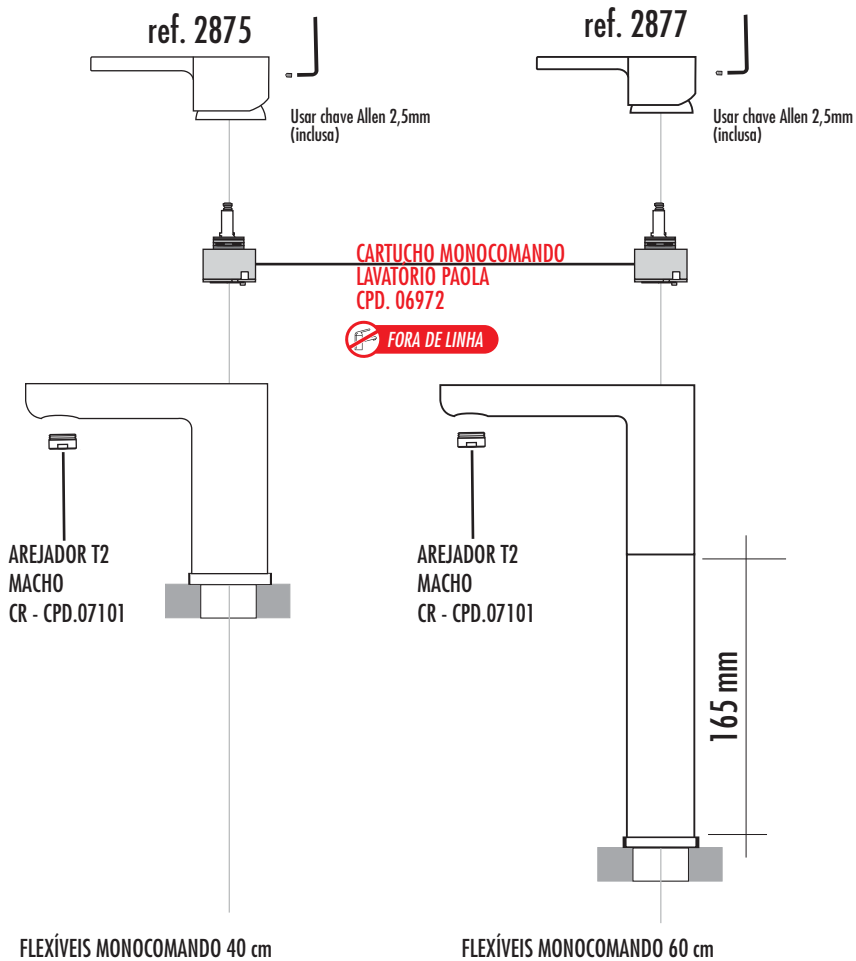

CPD.03151

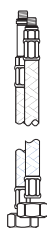

(Par de flexíveis)

CPD.03454

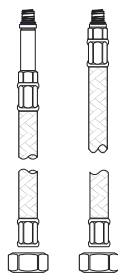

(Par de flexíveis)

Fora de linha

Acabamentos: tabela de produtos

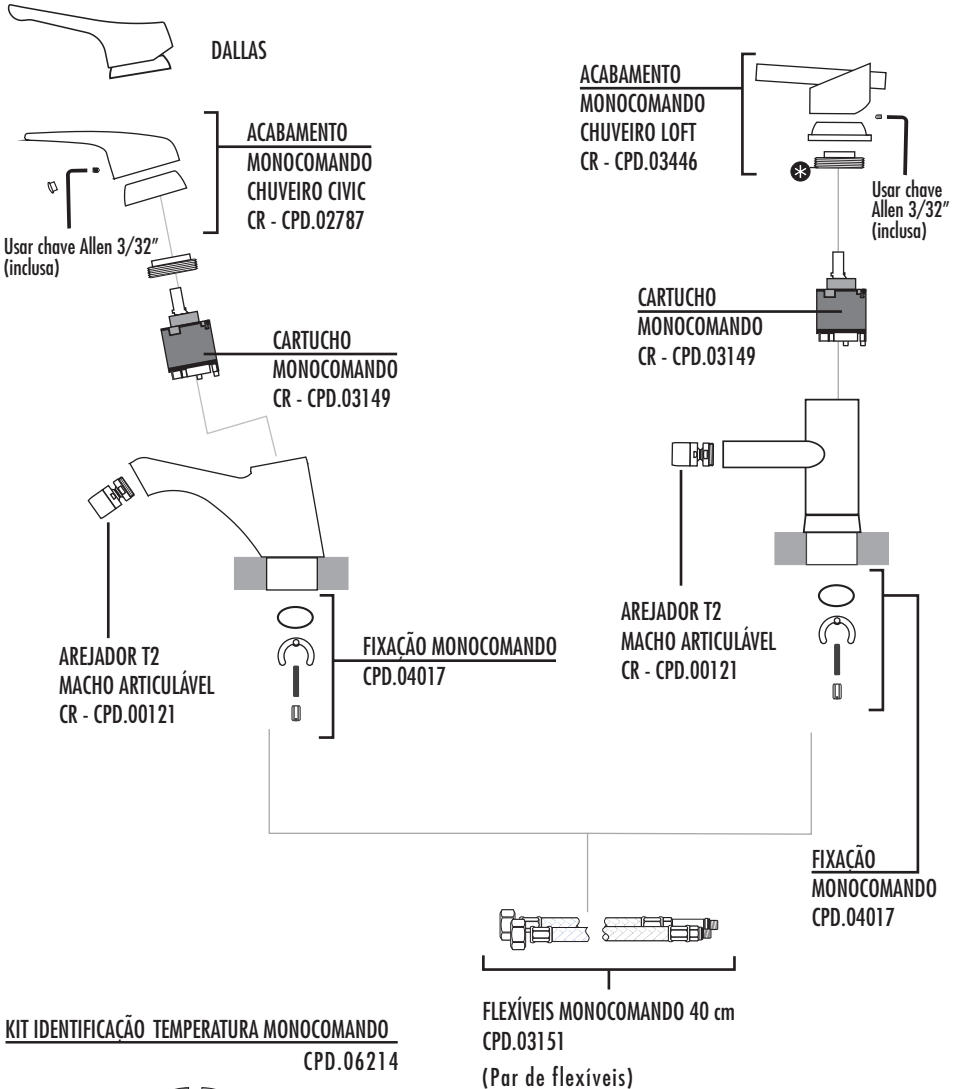

AZUL VERMELHO

Acabamentos: tabela de produtos

ACABAMENTO
MONOCOMANDO
CHUVEIRO CIVIC
CCR - CPD.02787

Usar chave Allen 3/32"
(inclusa)

CARTUCHO
MONOCOMANDO
COZINHA
CPD.04046

AREJADOR CURTO
T2 MACHO
CR - CPD.07225

 FORA DE LINHA

VEDAÇÃO MONOCOMANDO
COZINHA
CPD.06455

 FORA DE LINHA

FIXAÇÃO MONOCOMANDO
CPD.04017

FLEXÍVEIS MONOCOMANDO 40 cm
CPD.03151
(Par de flexíveis)

KIT IDENTIFICAÇÃO TEMPERATURA MONOCOMANDO
CPD.06214

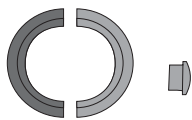

AZUL VERMELHO

PAOLA PULL OUT

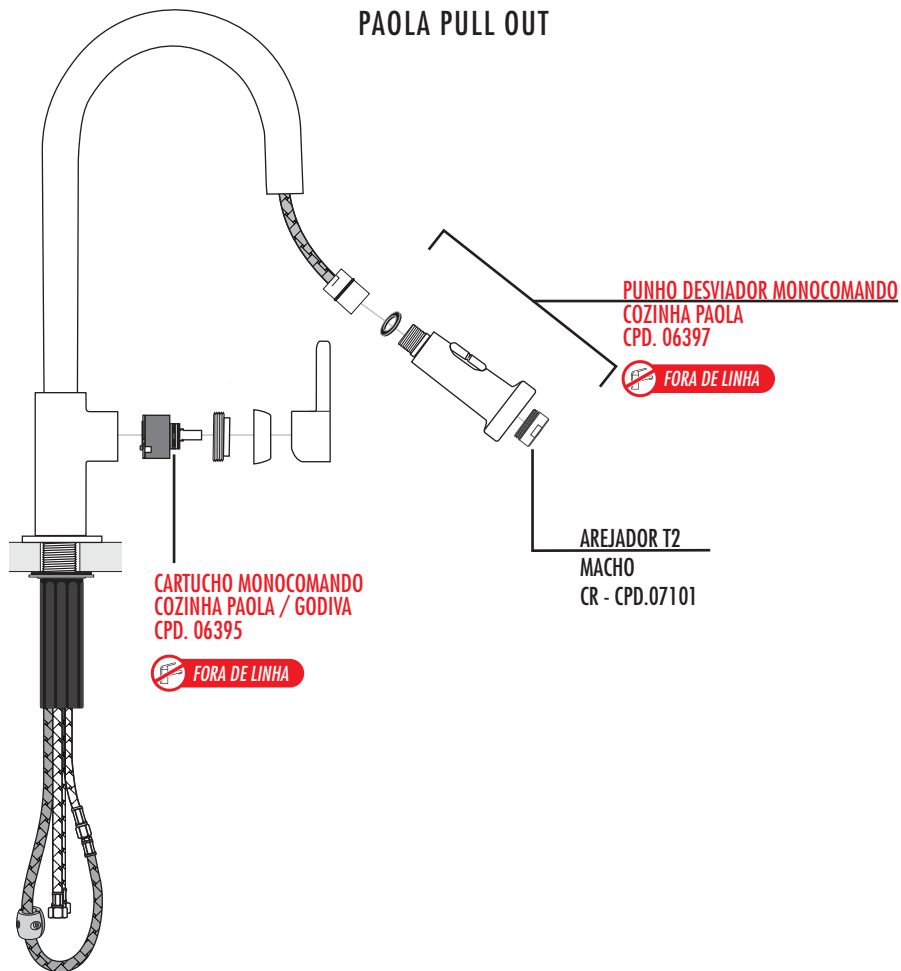

FLEXÍVEIS MONOCOMANDO 60 cm

CPD.03454

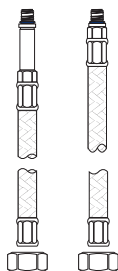

(Par de flexíveis)

MANGUEIRA PULL OUT MONOCOMANDO COZINHA PAOLA

CPD.06396

(FORA DE LINHA)



GODIVA PULL OUT

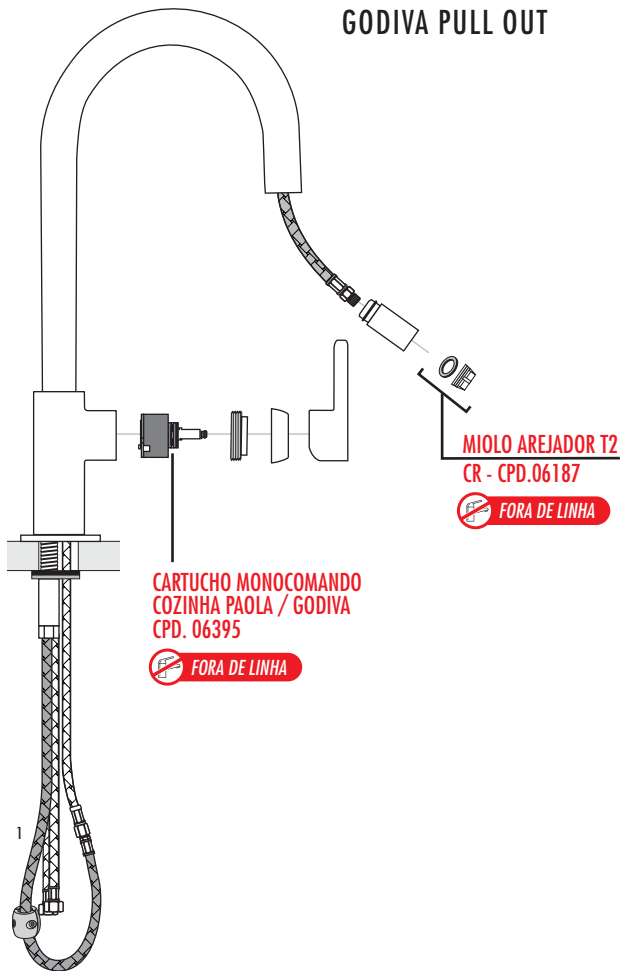

MIOLO AREJADOR T2
CR - CPD.06187

FORA DE LINHA

CARTUCHO MONOCOMANDO
COZINHA PAOLA / GODIVA
CPD. 06395

FORA DE LINHA

FLEXÍVEIS MONOCOMANDO 60 cm

CPD.03454

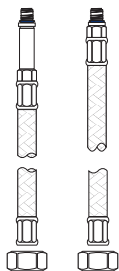

(Par de flexíveis)

MANGUEIRA PULL OUT MONOCOMANDO
COZINHA GODIVA

CPD.06468

FORA DE LINHA



GODIVA COZINHA

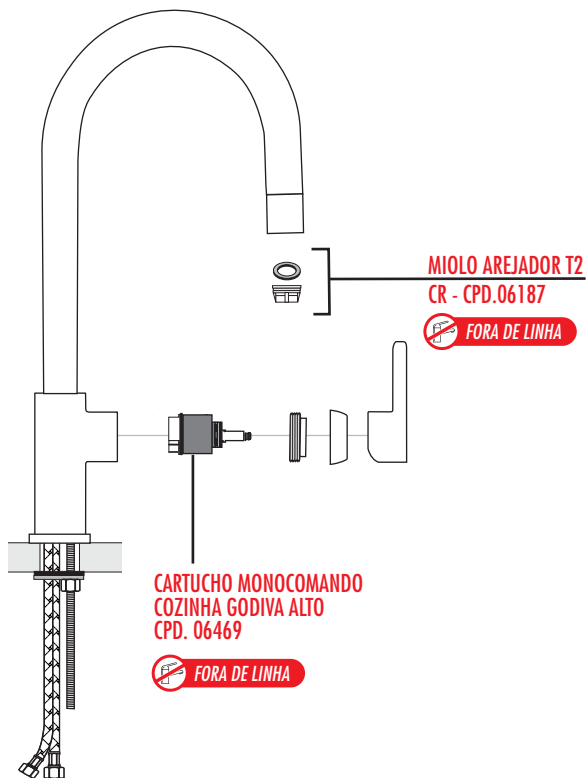

FLEXÍVEIS MONOCOMANDO 60 cm

CPD.03454

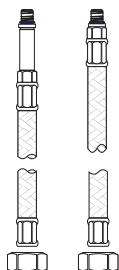

(Par de flexíveis)

GODIVA BRAÇO MÓVEL

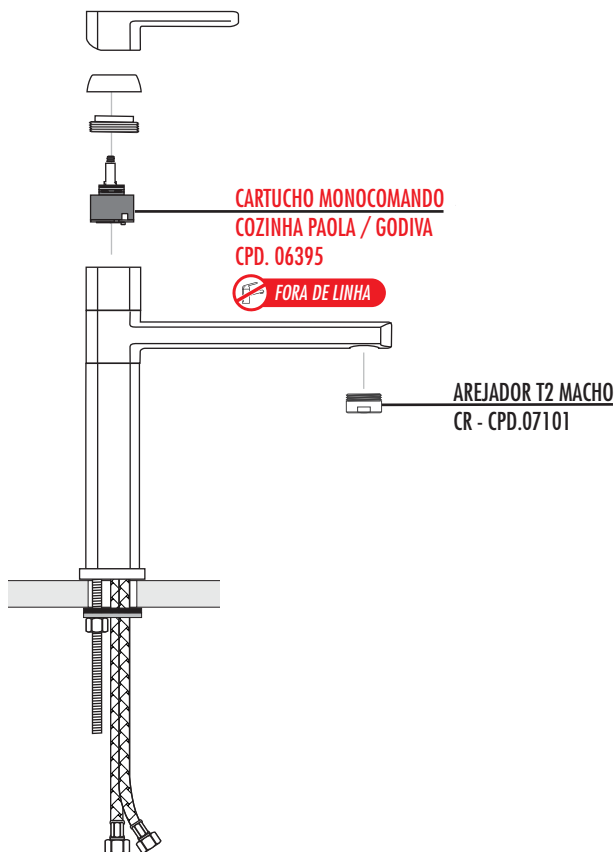

FLEXÍVEIS MONOCOMANDO 60 cm

CPD.03454

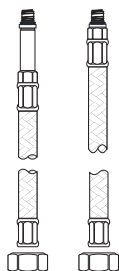

(Par de flexíveis)

Acabamentos: tabela de produtos

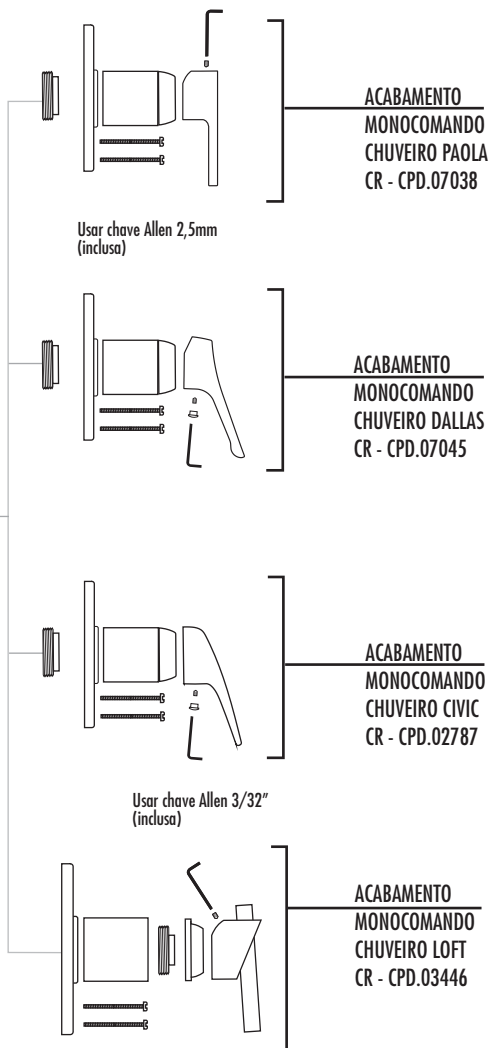
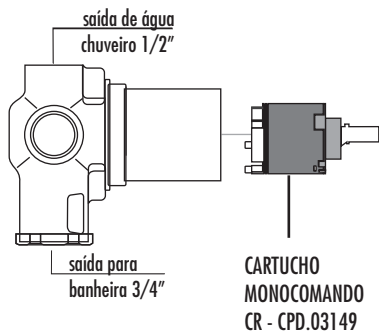

KIT IDENTIFICAÇÃO TEMPERATURA MONOCOMANDO
CPD.06214



AZUL VERMELHO

Acabamentos: tabela de produtos

Os Misturadores Monocomando com Desviador devem ser instalados em locais com pressão mínima de 5 mca.

VEDAÇÃO BOTÃO
DESVIADOR
MONOCOMANDO
CHUVEIRO
CPD.03520

 FORA DE LINHA

ACABAMENTO
MONOCOMANDO
DESVIADOR CIVIC
CR - CPD.04056

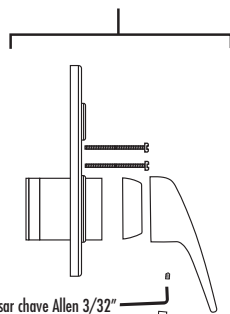

Usar chave Allen 3/32" (inclusa)

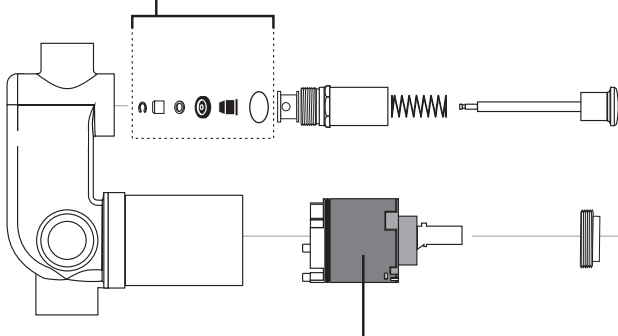

CARTUCHO
MONOCOMANDO
CR - CPD.03149

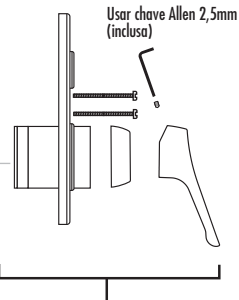

Usar chave Allen 2,5mm (inclusa)

KIT IDENTIFICAÇÃO TEMPERATURA MONOCOMANDO

CPD.06214



AZUL VERMELHO

ACABAMENTO
MONOCOMANDO
DESVIADOR DALLAS
CR - CPD.07046

LAVATÓRIO - BANCA

Página 4.01

- Detalhamento de Reparos

Página 4.11

LAVATÓRIO - PAREDE

Página 4.21

LAVATÓRIO/COZINHA

Página 4.25

TORNEIRAS PARA COZINHA

Página 4.31

- Saída lateral
- Tubo alto banca
- Tubo alto parede
- Detalhamento de Reparos

Página 4.31

Página 4.37

Página 4.42

Página 4.43

TORNEIRAS DE USO GERAL

Página 4.44

- Cozinha
- Máquina de Lavar
- Cozinha Filtro
- Cozinha e Tanque
- Torneiras de Filtro
- Tanque, Cozinha e Jardim
- Tanque e Jardim
- Top Jet
- Detalhamento de Reparos

Página 4.44

Página 4.47

Página 4.50

Página 4.53

Página 4.54

Página 4.57

Página 4.59

Página 4.60

Página 4.62

Fora de linha



Squadra



Trezzo



PRENSA CANOPLA T1/T2
CPD.00185

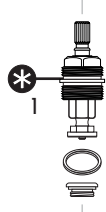

MECANISMO COMPLETO
TORNEIRA/MISTURADOR M20
CPD.08473
Sede M14
usar chave Allen 7mm
(não inclusa)

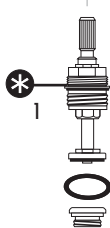

MECANISMO COMPLETO
TORNEIRAS 1/2"
CPD.01881
Sede M14
usar chave Allen 7mm
(não inclusa)

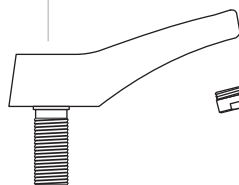

AREJADOR T2 MACHO
CR - CPD.07101

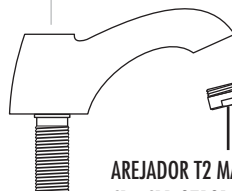

AREJADOR T2 MACHO
CR - CPD.07101



FLANGE 1/2"
CPD.05055



Opções de arejadores ver grupo 10.



Recursos especiais para casos específicos procure nas páginas de detalhamento dos reparos.

Fora de linha



Image



Orion



PRENSA CANOPLA T1/T2
CPD.00185

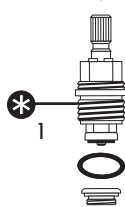

CASTELO REGISTRO
LATERAL BASECLIC
CPD.00514
Sede M14
usar chave Allen 7mm
(não inclusa)

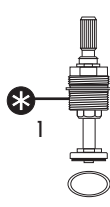

MECANISMO COMPLETO
TORNEIRAS M20
CPD.01091
Sede M14
usar chave Allen 7mm
(não inclusa)

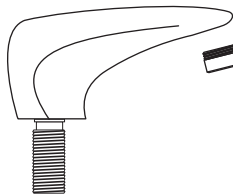

AREJADOR T1 MACHO
CR - CPD.03085

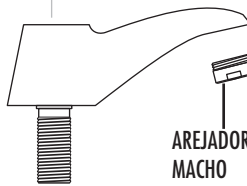

AREJADOR T2
MACHO
CR - CPD.07101



FLANGE 1/2"
CPD.05055



Opções de arejadores ver grupo 10.



Recursos especiais para casos específicos procure nas páginas de detalhamento dos reparos.

ACABAMENTO TORNEIRA MISTY
CR - CPD.03135



Misty



Aquarius

ACABAMENTO TORNEIRA
SOHO
CR - CPD.04316



Soho

PRENSA CANOPLA
AQUARIUS
CR - CPD.01639

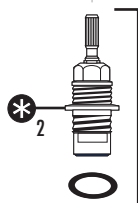

MECANISMO CERÂMICO
1/2" FECHAMENTO
HORÁRIO
CPD.02102

CANOPLA TORNEIRA
BANCA
CPD.05008

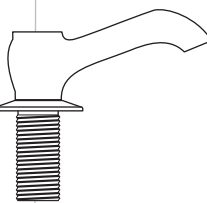

FLANGE 1/2"
CPD.05055



Recursos especiais para casos específicos procure nas páginas de detalhamento dos reparos.

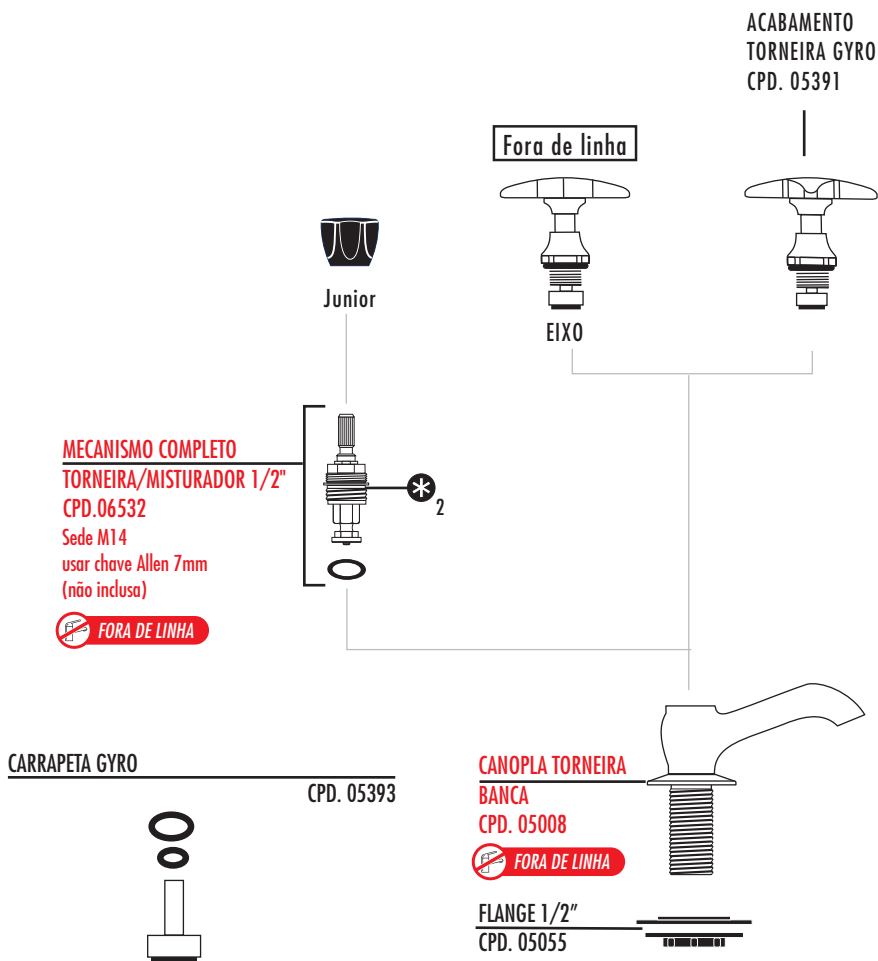

Recursos especiais para casos específicos procure nas páginas de detalhamento dos reparos.

Fora de linha

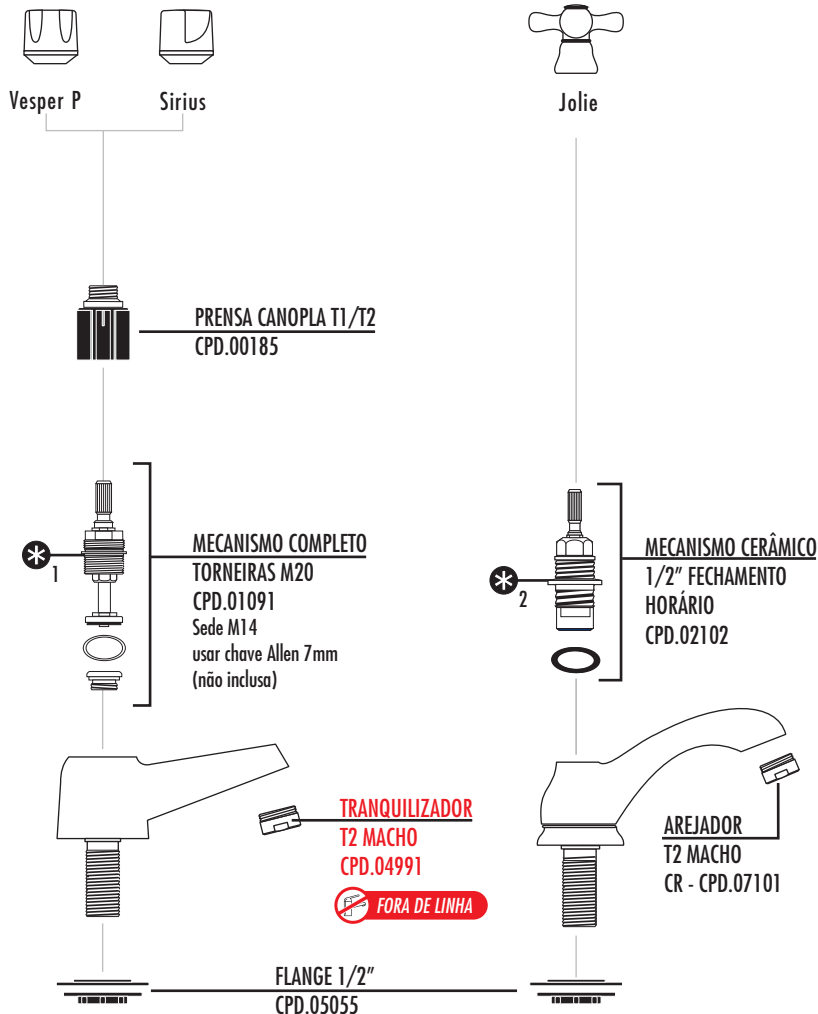

Opções de arejadores ver grupo 10.



Recursos especiais para casos específicos procure nas páginas de detalhamento dos reparos.

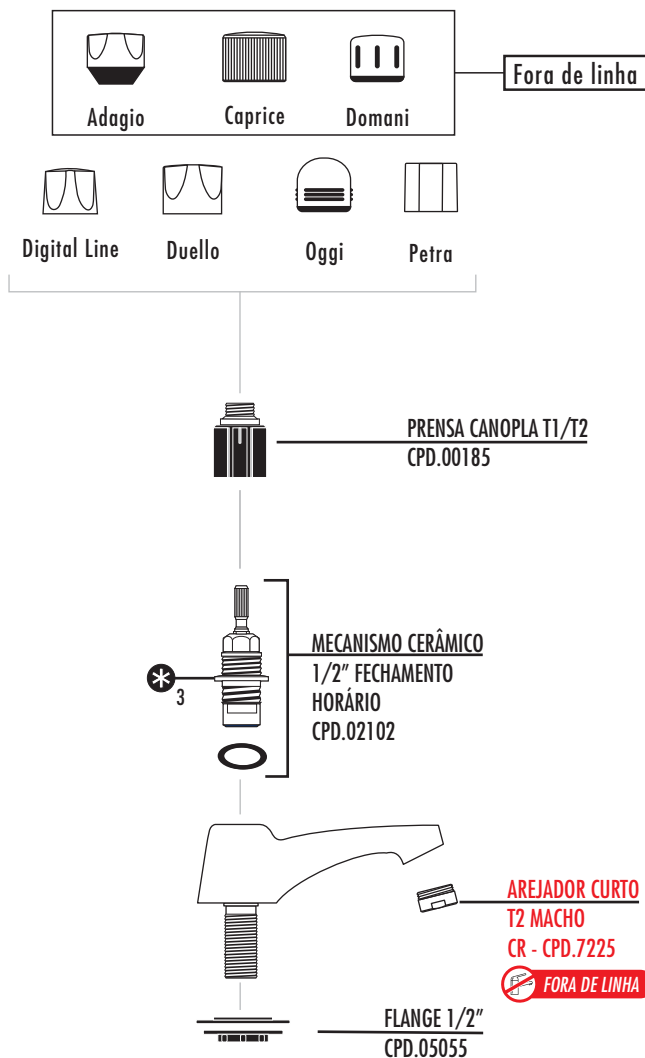

Para torneiras das linhas Oggi, Domani e Digital Line anteriores a 1999, utilizar o castelo CPD 01091. Para torneiras das linhas Adagio, Duello e Caprice, anteriores a 2000, utilizar o castelo CPD 08473.

Opções de arejadores ver grupo 10.



Recursos especiais para casos específicos procure nas páginas de detalhamento dos reparos.



Ascot



Lyon



PRENSA CANOPLA T1/T2
CPD.00185



Aquarius

ACABAMENTO TORNEIRA
SOHO

CR - CPD.04316

FORA DE LINHA

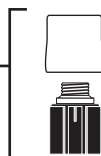

PRENSA CANOPLA
AQUARIUS
CR - CPD.01639



Soho

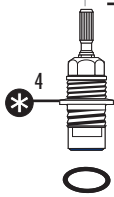

MECANISMO CERÂMICO
1/2" FECHAMENTO
HORÁRIO
CPD.02102

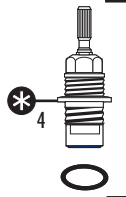

MECANISMO CERÂMICO
1/2" FECHAMENTO
HORÁRIO
CPD.02102

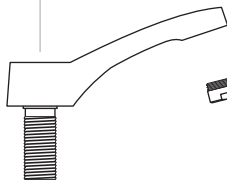

AREJADOR CURTO
T2 MACHO
CR - CPD.7225

FORA DE LINHA

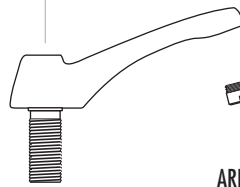

AREJADOR
T2 MACHO
CR - CPD.07101

FLANGE 1/2"
CPD.05055

Opções de arejadores ver grupo 10.



Recursos especiais para casos específicos procure nas páginas de detalhamento dos reparos.



Ascot



Digital Line



Domani

Fora de linha



Duello



Lyon



Oggi

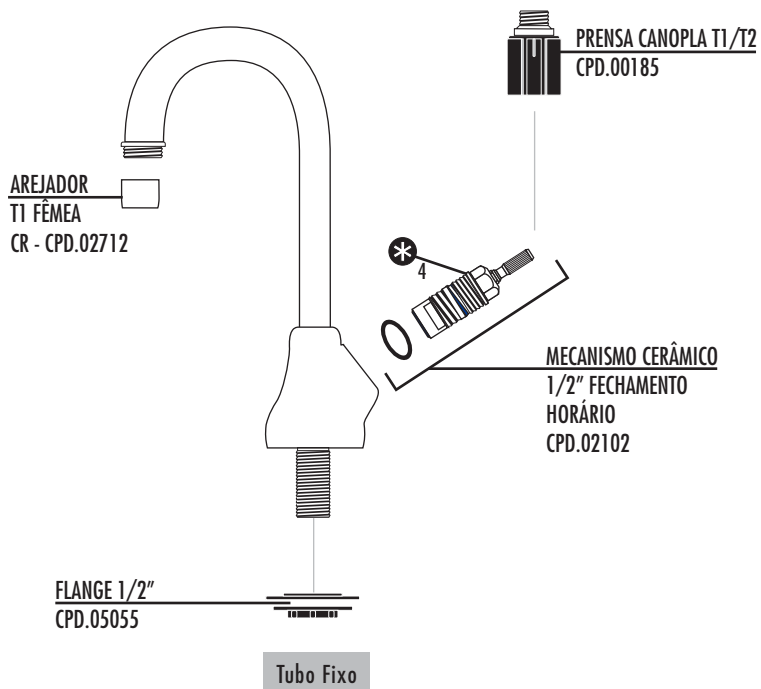

Opções de arejadores ver grupo 10.



Recursos especiais para casos específicos procure nas páginas de detalhamento dos reparos.

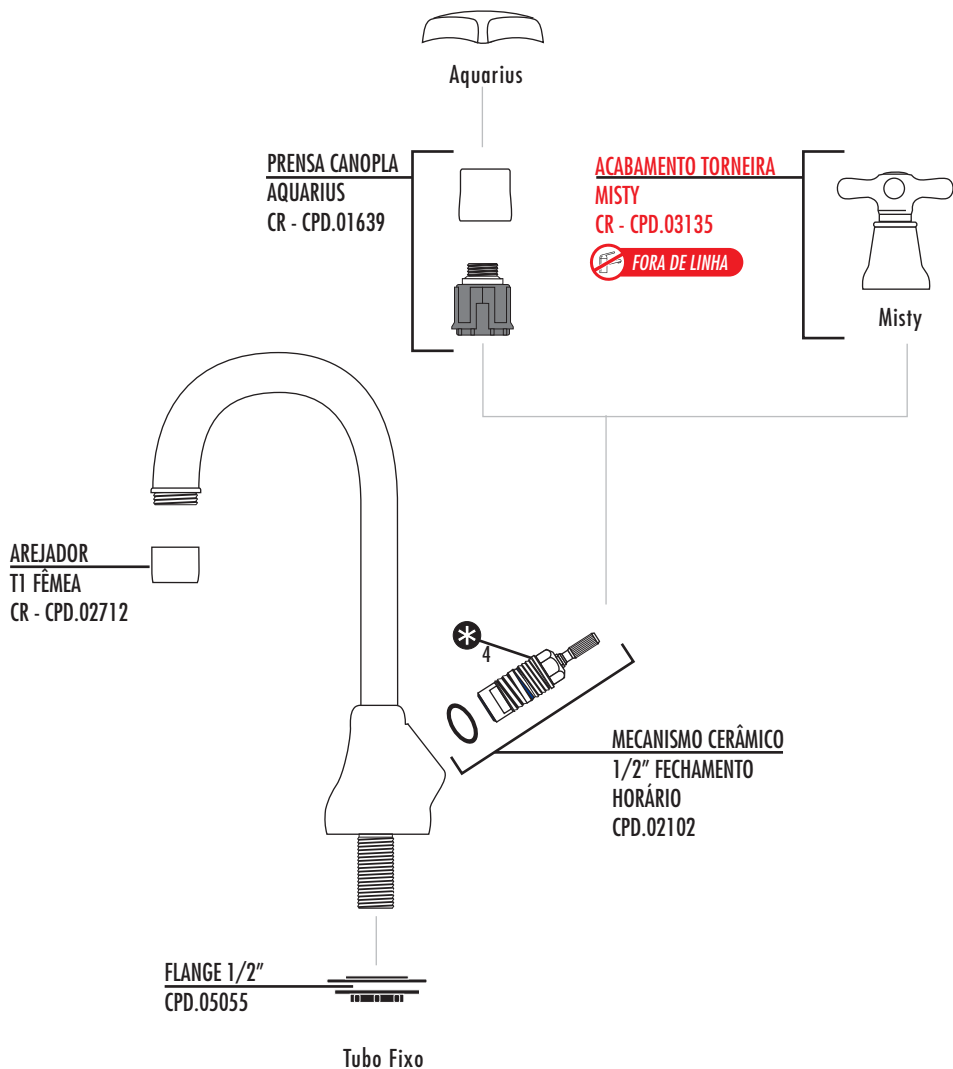

Opções de arejadores ver grupo 10.



Recursos especiais para casos específicos procure nas páginas de detalhamento dos reparos.

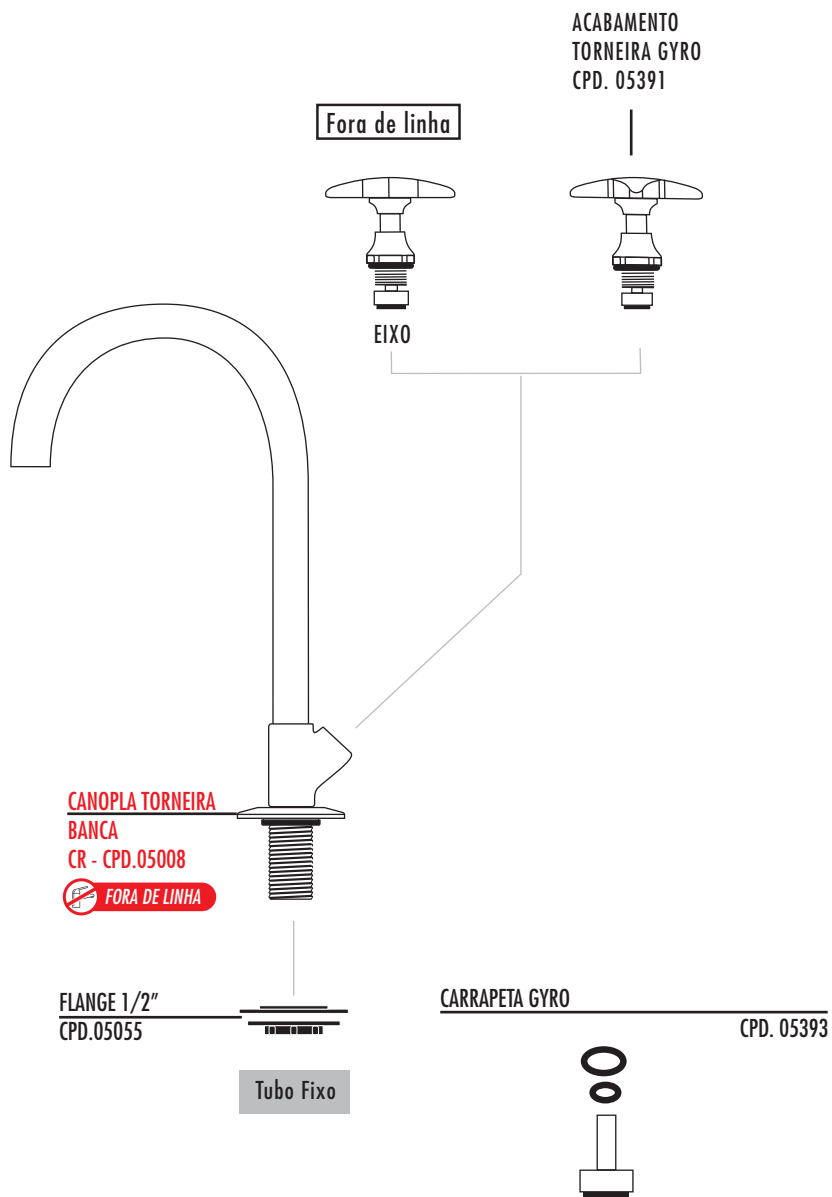

DETALHAMENTO DE REPAROS

*₁ VEDAÇÃO CASTELOS 1/2", 3/4"

CPD.01109

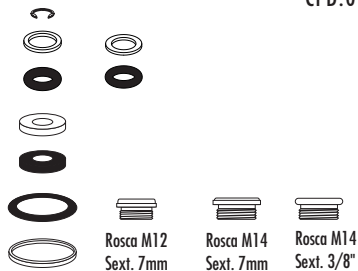
*₂ MECANISMO COMPLETO TORNEIRA / MISTURADOR M20

CPD.08473

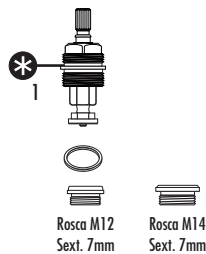
*₃ MECANISMO COMPLETO TORNEIRAS 1/2"

CPD.01881

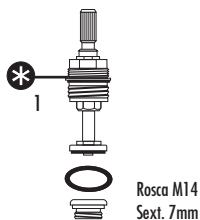
*₄ CASTELO REGISTRO LATERAL BASECLIC

CPD.00514

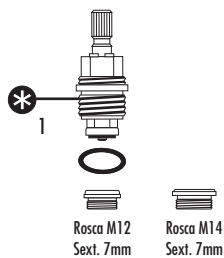

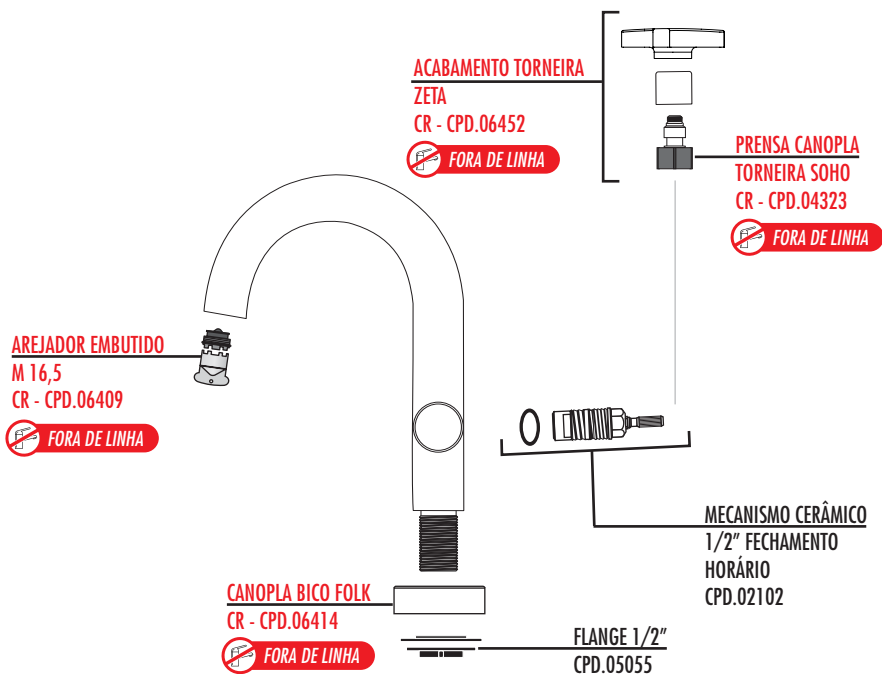
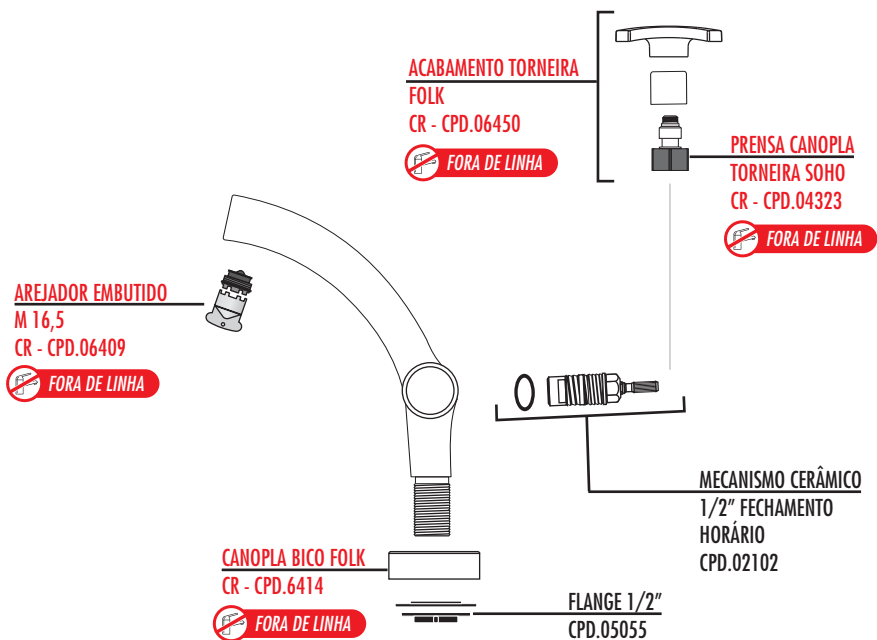

TUBO TORNEIRA LAVATÓRIO SOHO
CR - CPD.04327

 FORA DE LINHA

ACABAMENTO TORNEIRA
SOHO
CR - CPD.04316

 FORA DE LINHA

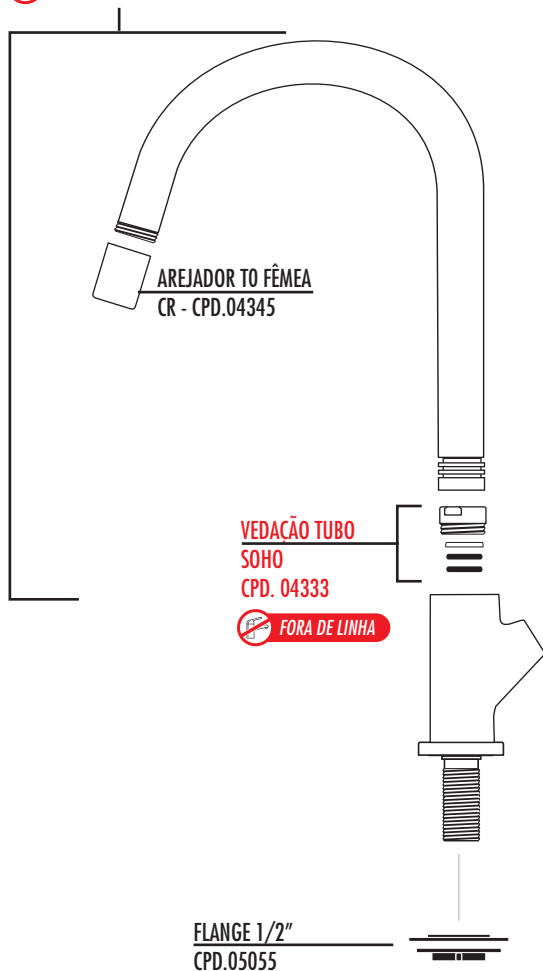

AREJADOR TO FÊMEA
CR - CPD.04345

VEDAÇÃO TUBO
SOHO
CPD. 04333

 FORA DE LINHA

FLANGE 1/2"
CPD.05055



Soho

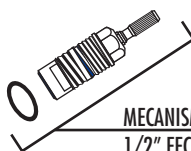

MECANISMO CERÂMICO
1/2" FECHAMENTO
HORÁRIO
CPD.02102

Tubo Móvel

Opções de arejadores ver grupo 10.

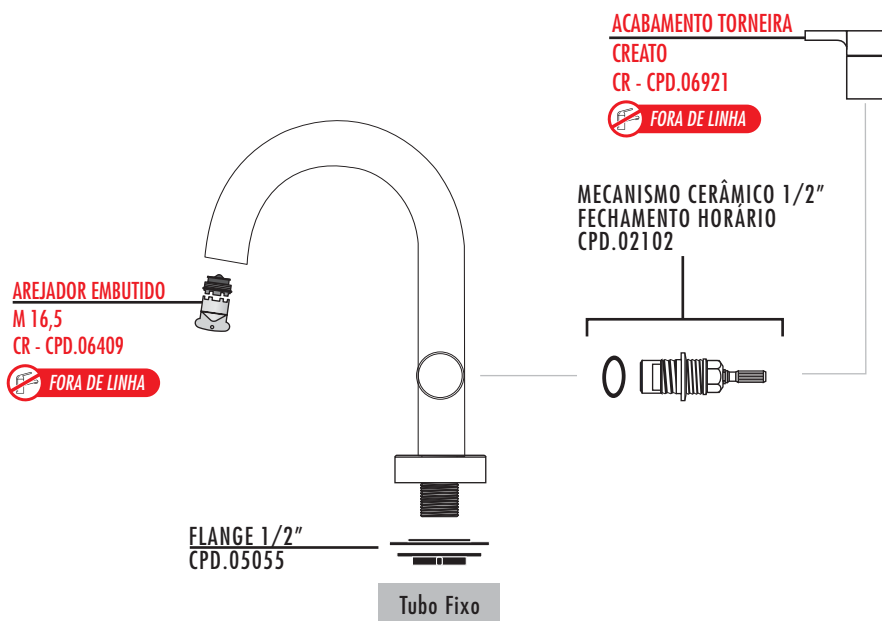
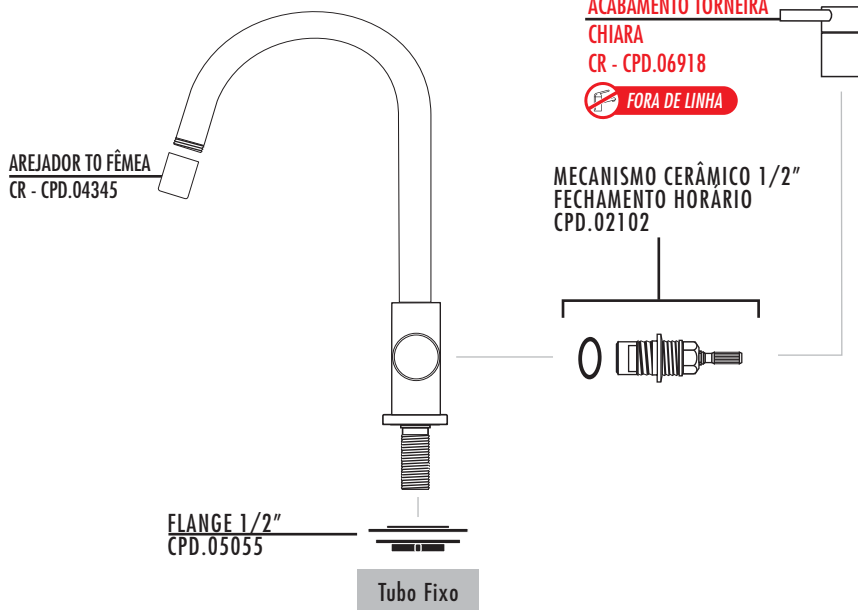

Opções de arejadores ver grupo 10.

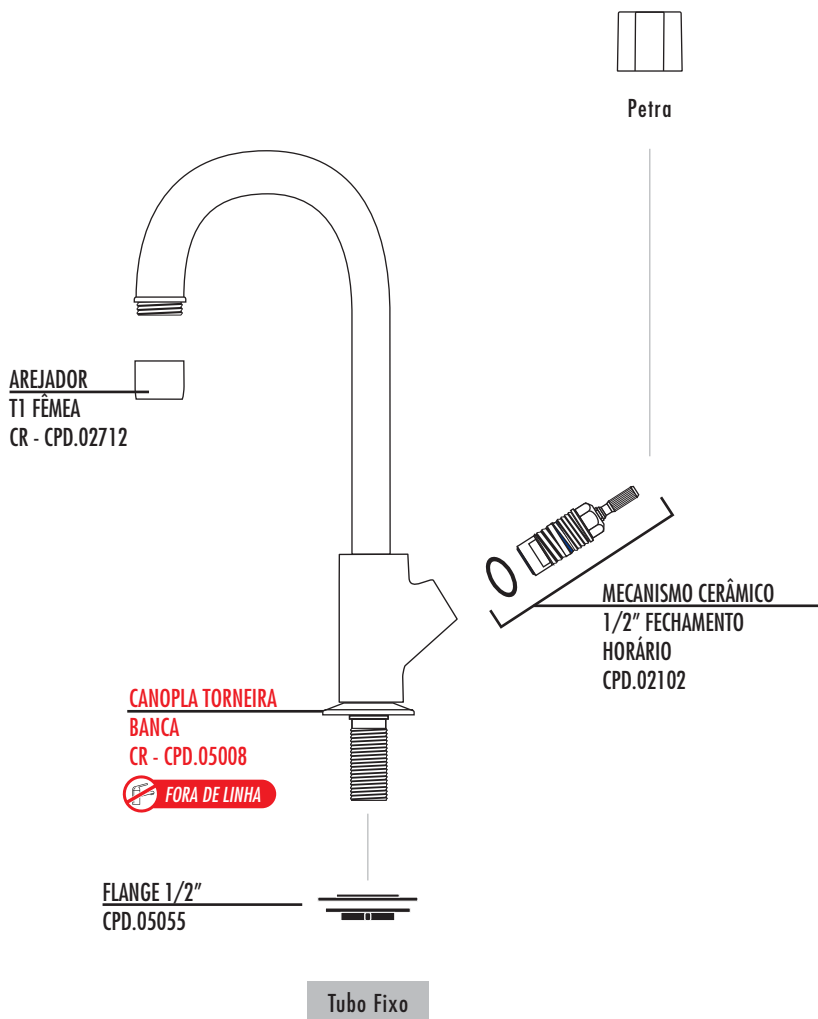

Opções de arejadores ver grupo 10.

Fora de linha

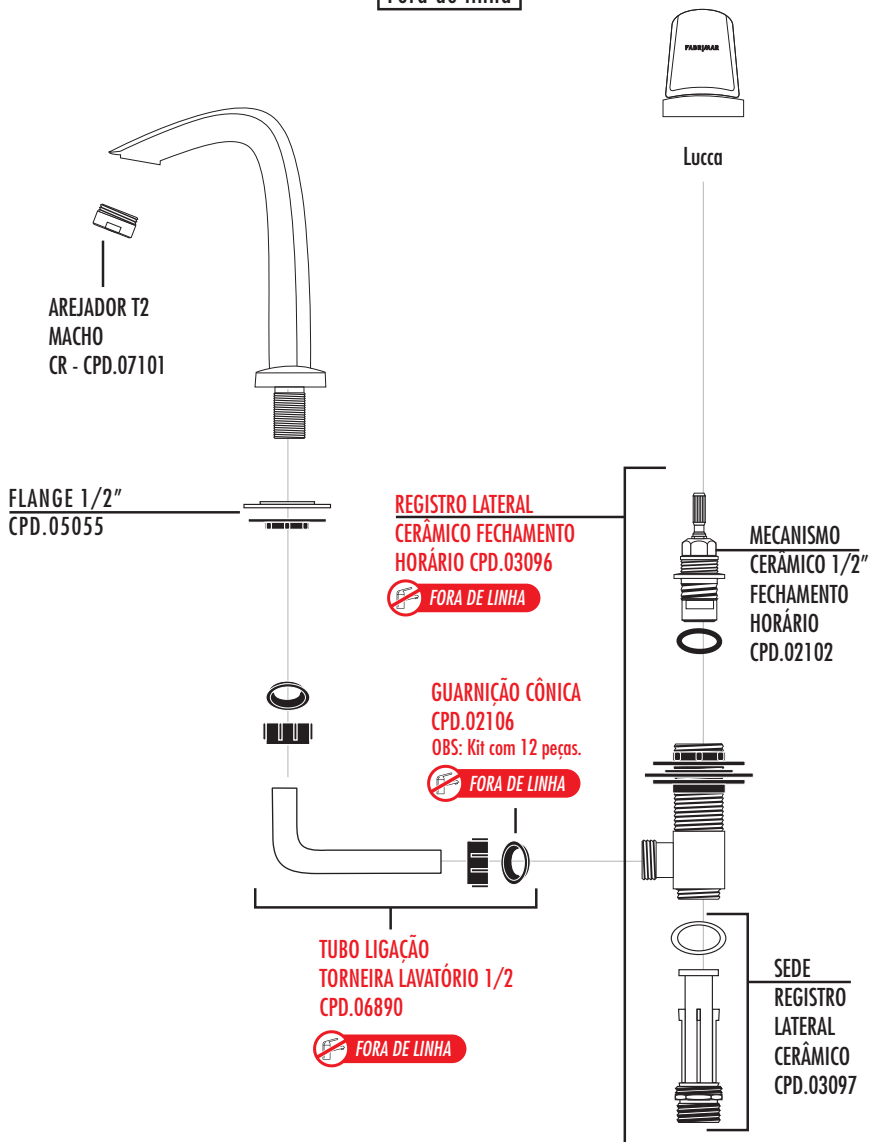

Opções de arejadores ver grupo 10.

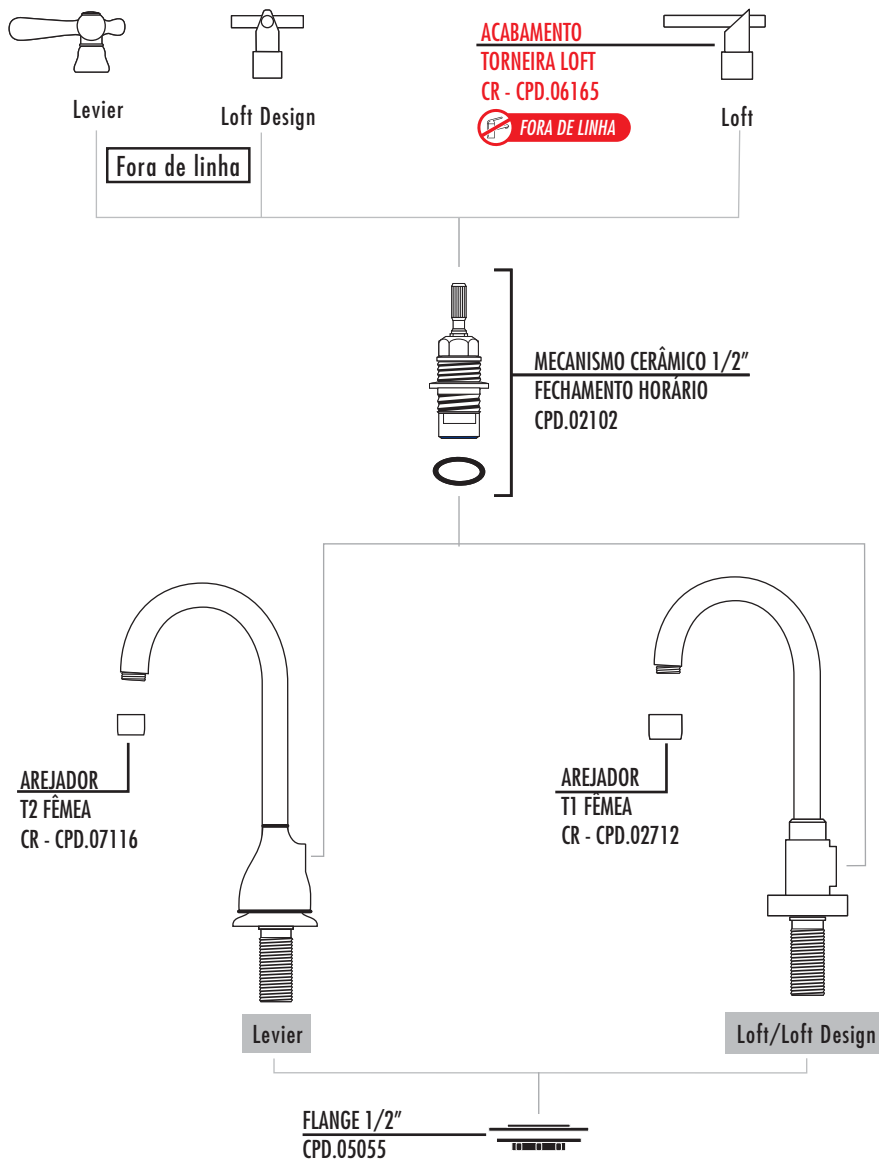

Opções de arejadores ver grupo 10.

Fora de linha



Innovare
Classic



Innovare



Saga



Saga Cross



MECANISMO CERÂMICO 1/2"
FECHAMENTO HORÁRIO
CPD.02102

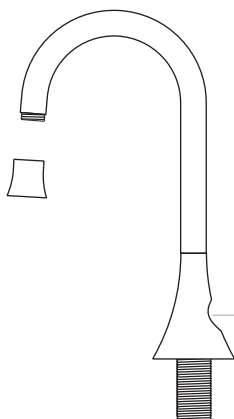

Innovare

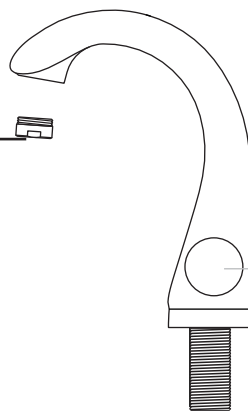

Saga

AREJADOR
T2 MACHO
CR - CPD.07101

FLANGE 1/2"
CPD.05055



Opções de arejadores ver grupo 10.

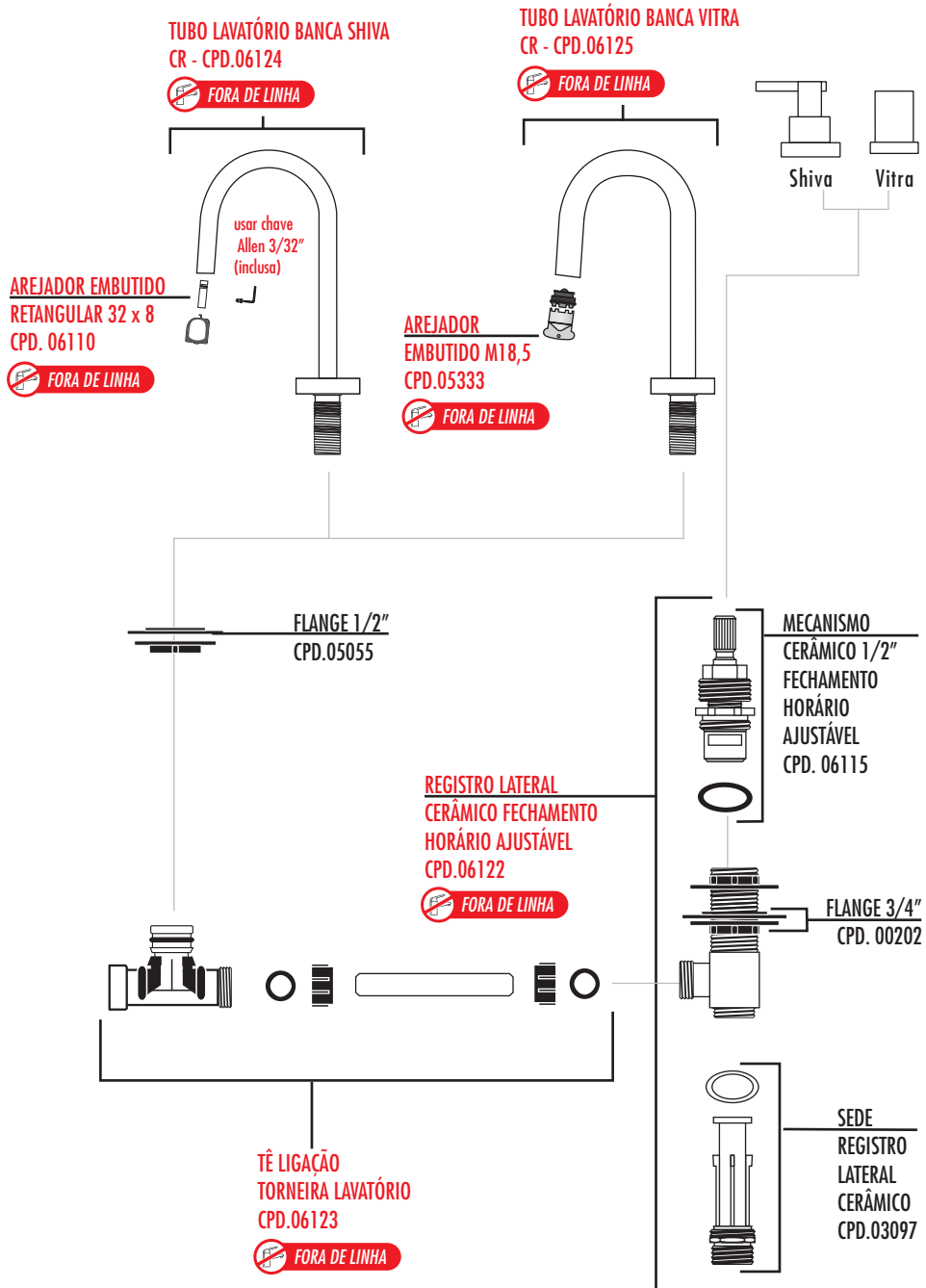

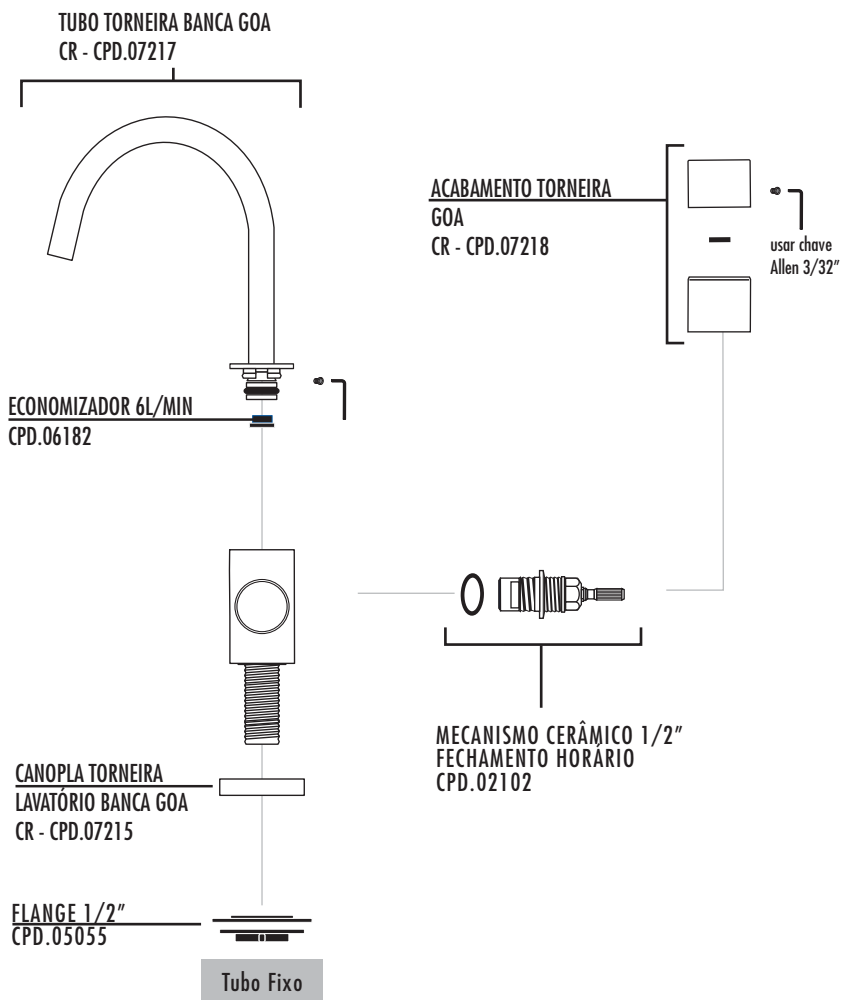

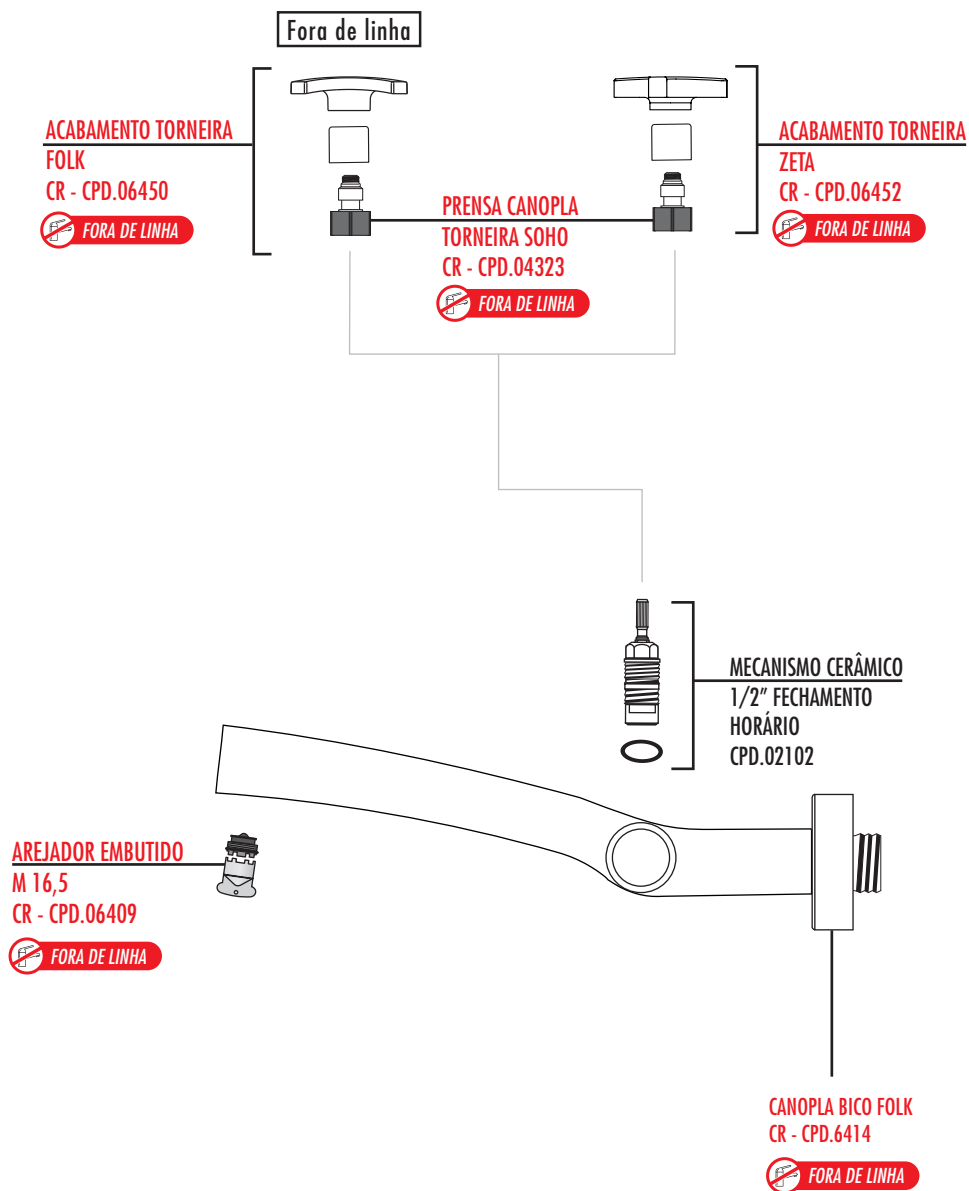

ACABAMENTO TORNEIRA
SOHO
CR - CPD.04316

 FORA DE LINHA

ACABAMENTO TORNEIRA
LOFT
CR - CPD.06165

 FORA DE LINHA

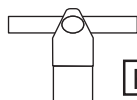

Loft Design



Soho

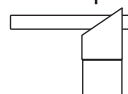

Loft

Fora de linha

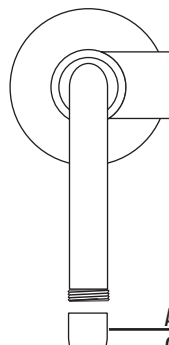

AREJADOR T1 FÊMEA
CR - CPD.02712



MECANISMO CERÂMICO 1/2"
FECHAMENTO HORÁRIO
CPD.02102

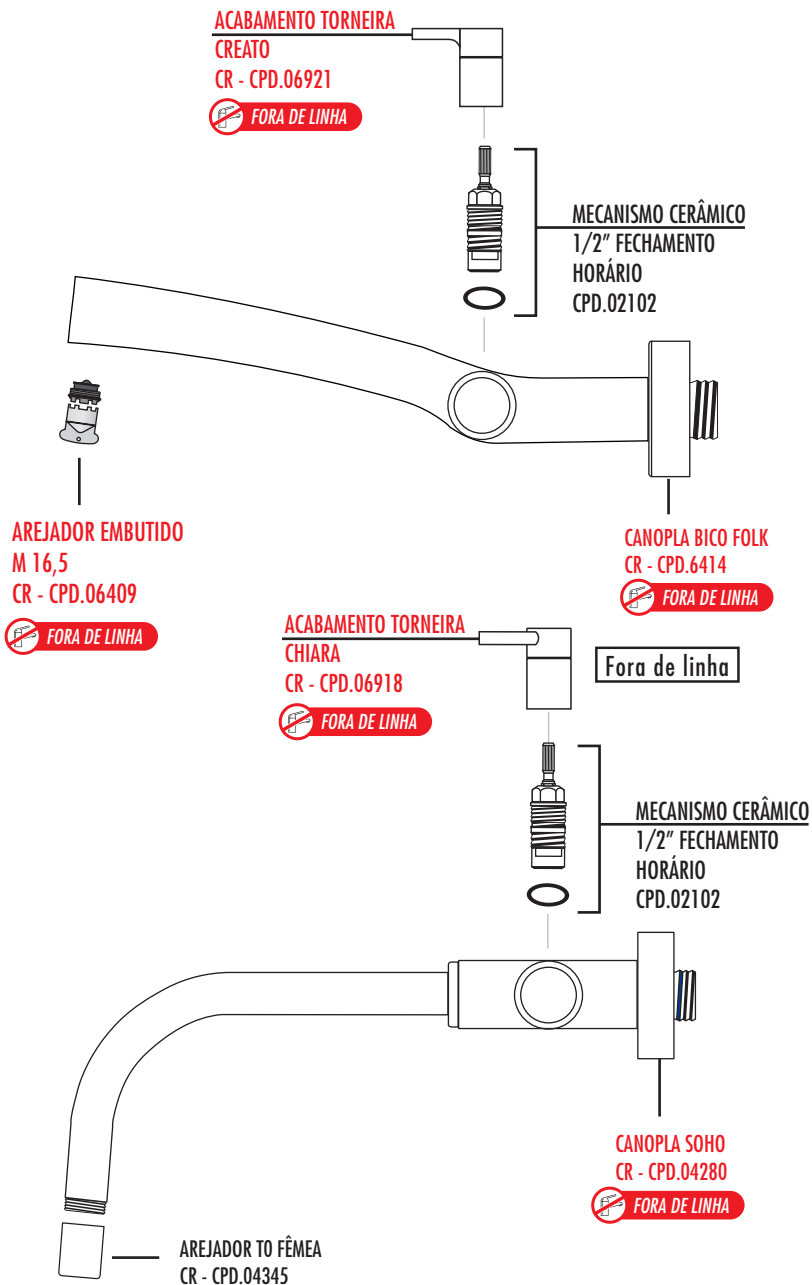

Opções de arejadores ver grupo 10.

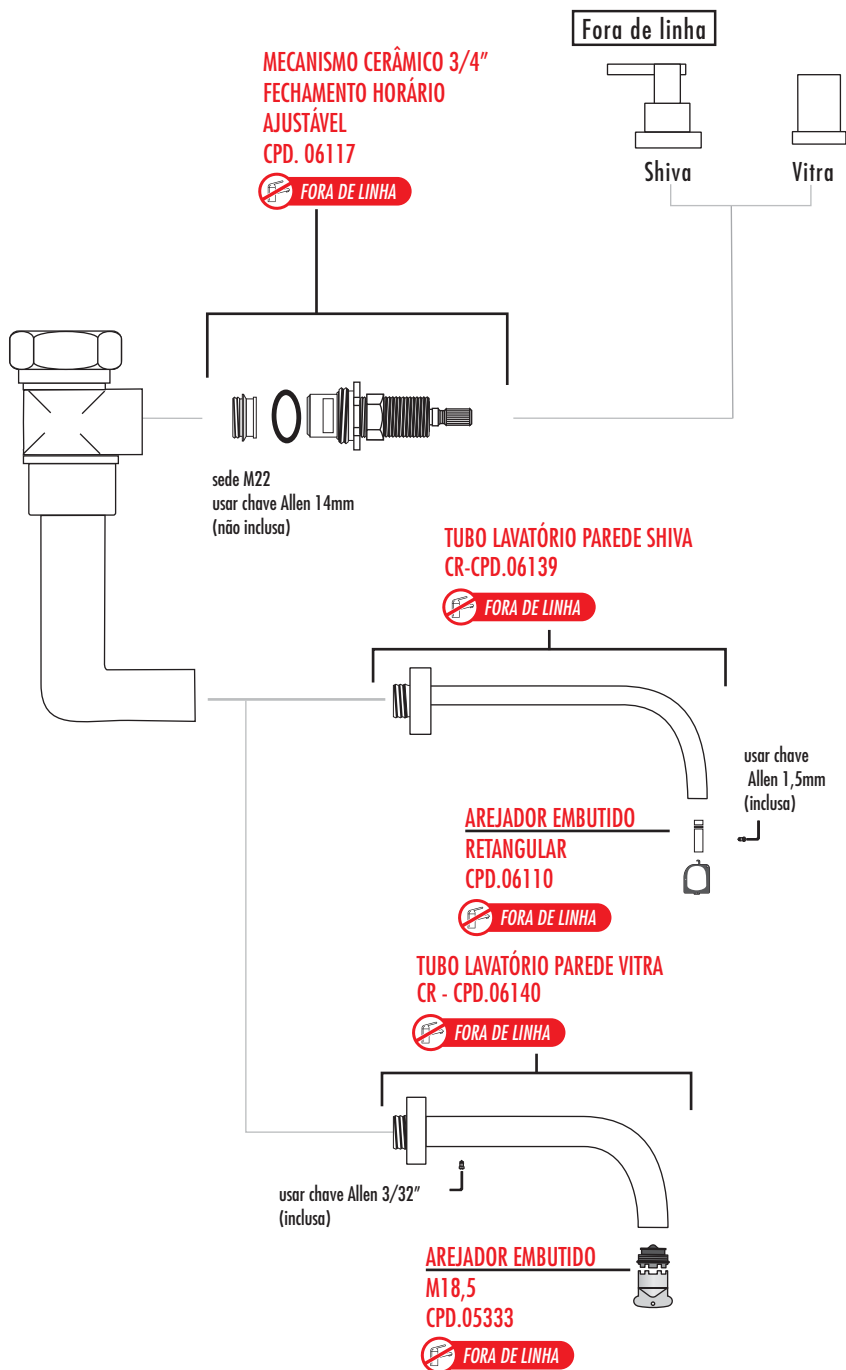

Fora de linha

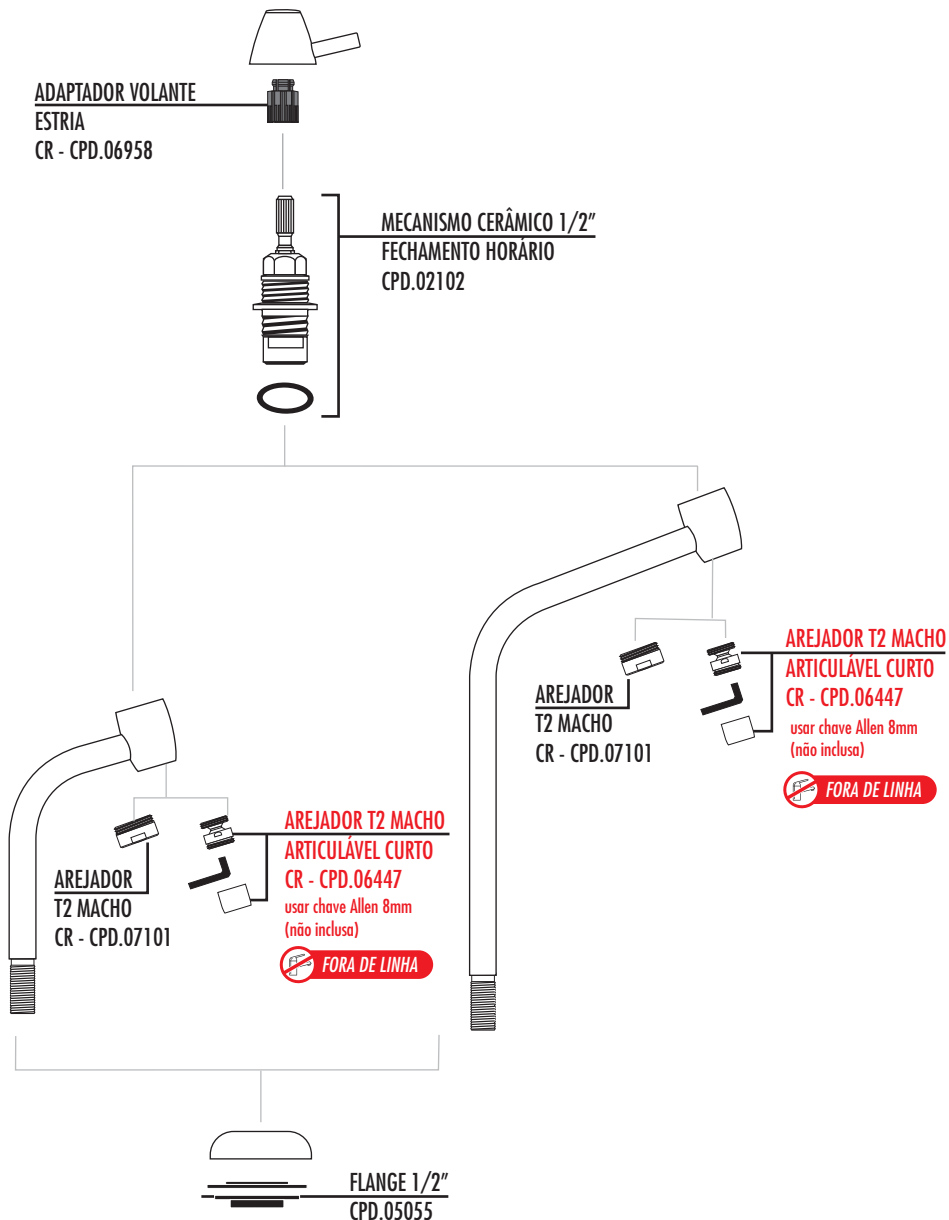

Opções de arejadores ver grupo 10.

Fora de linha

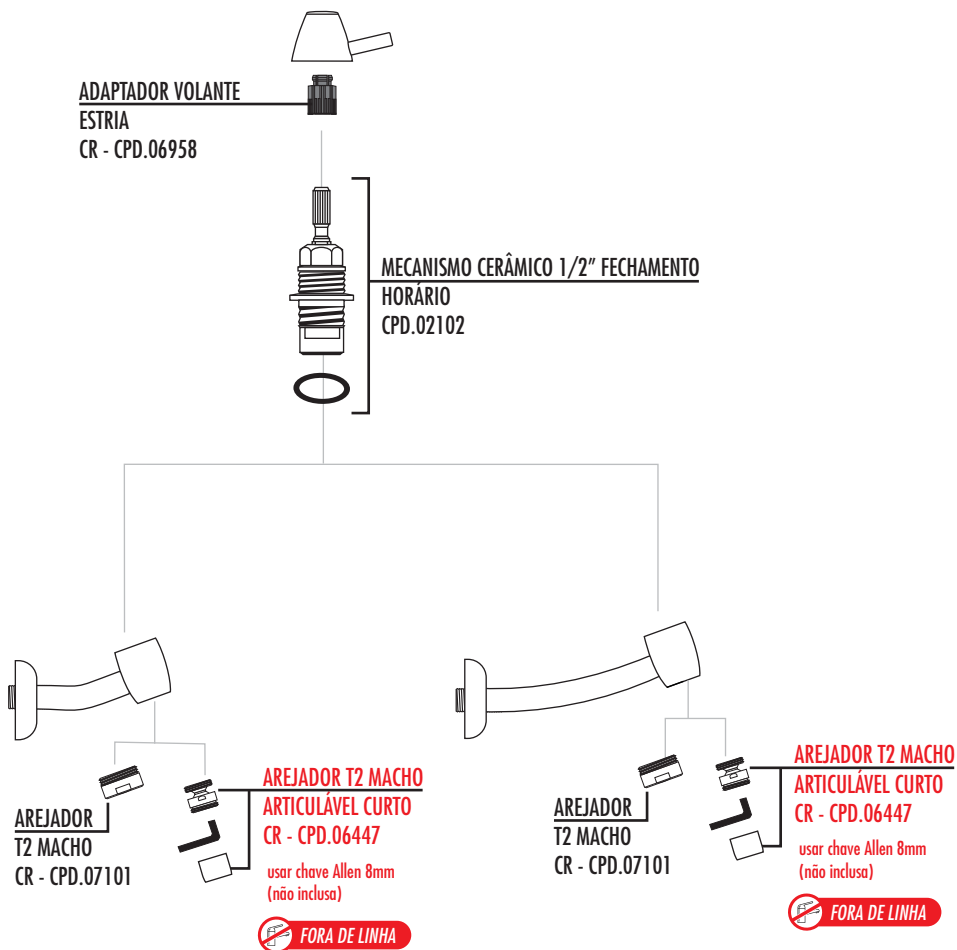

Opções de arejadores ver grupo 10.

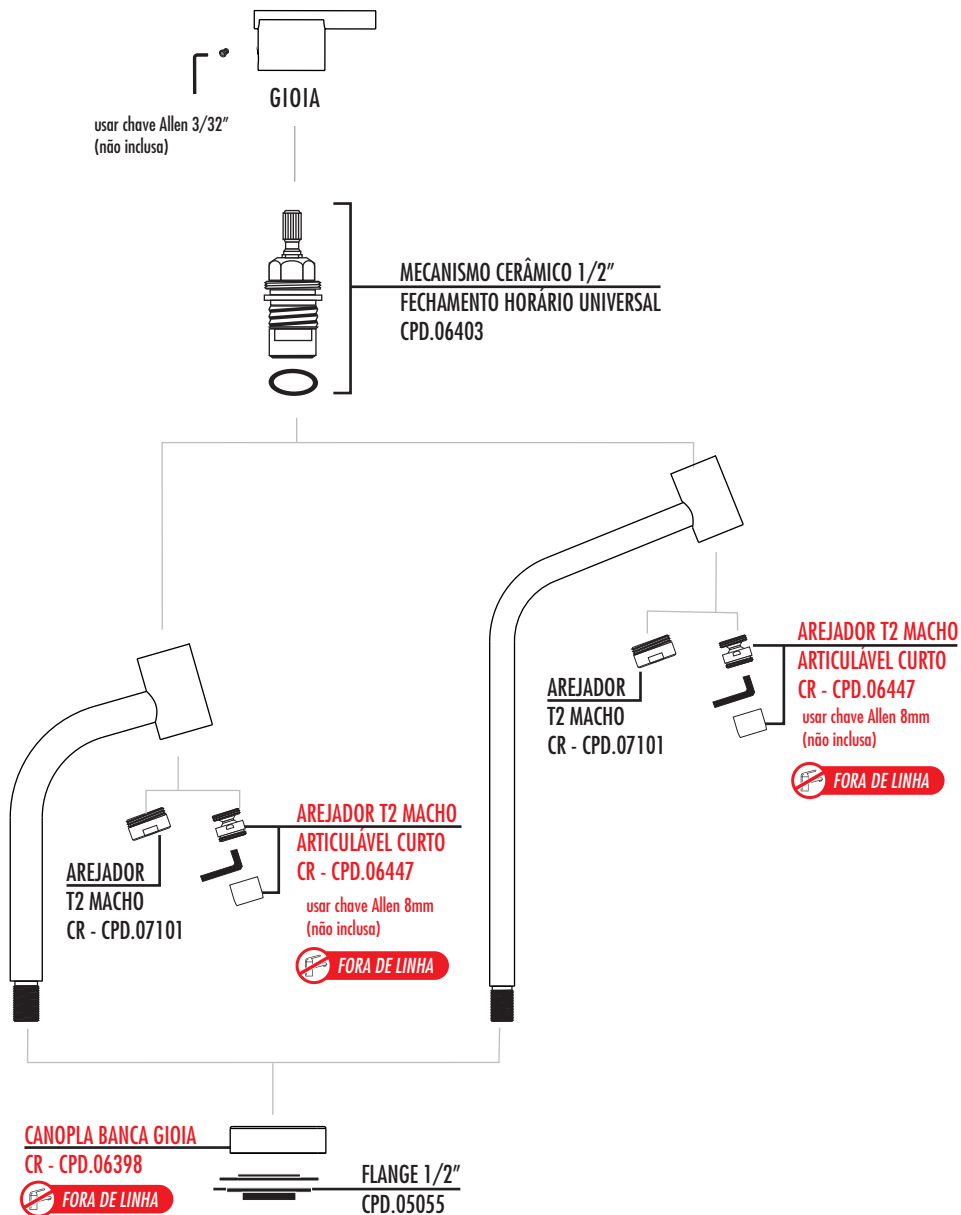

Opções de arejadores ver grupo 10.

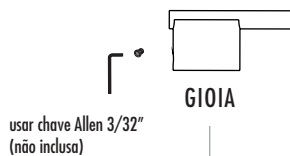

GIOIA

usar chave Allen 3/32"
(não inclusa)



MECANISMO CERÂMICO 1/2"
FECHAMENTO HORÁRIO UNIVERSAL
CPD.06403

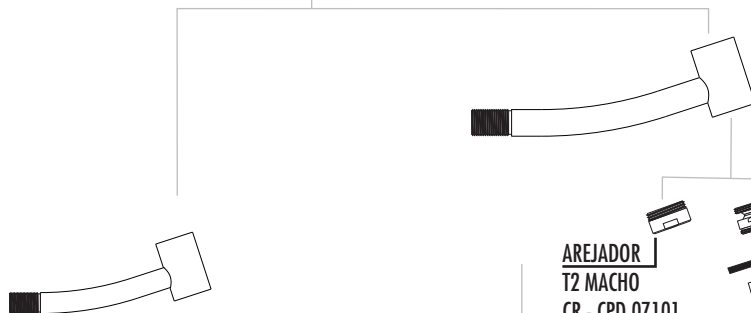

AREJADOR T2 MACHO
ARTICULÁVEL CURTO
CR - CPD.06447

usar chave Allen 8mm
(não inclusa)

FORA DE LINHA

AREJADOR
T2 MACHO
CR - CPD.07101

AREJADOR
T2 MACHO
CR - CPD.07101

AREJADOR T2 MACHO
ARTICULÁVEL CURTO
CR - CPD.06447

usar chave Allen 8mm
(não inclusa)

FORA DE LINHA

CANOPLA PAREDE GIOIA
CR - CPD.06399

FORA DE LINHA

Opções de arejadores ver grupo 10.

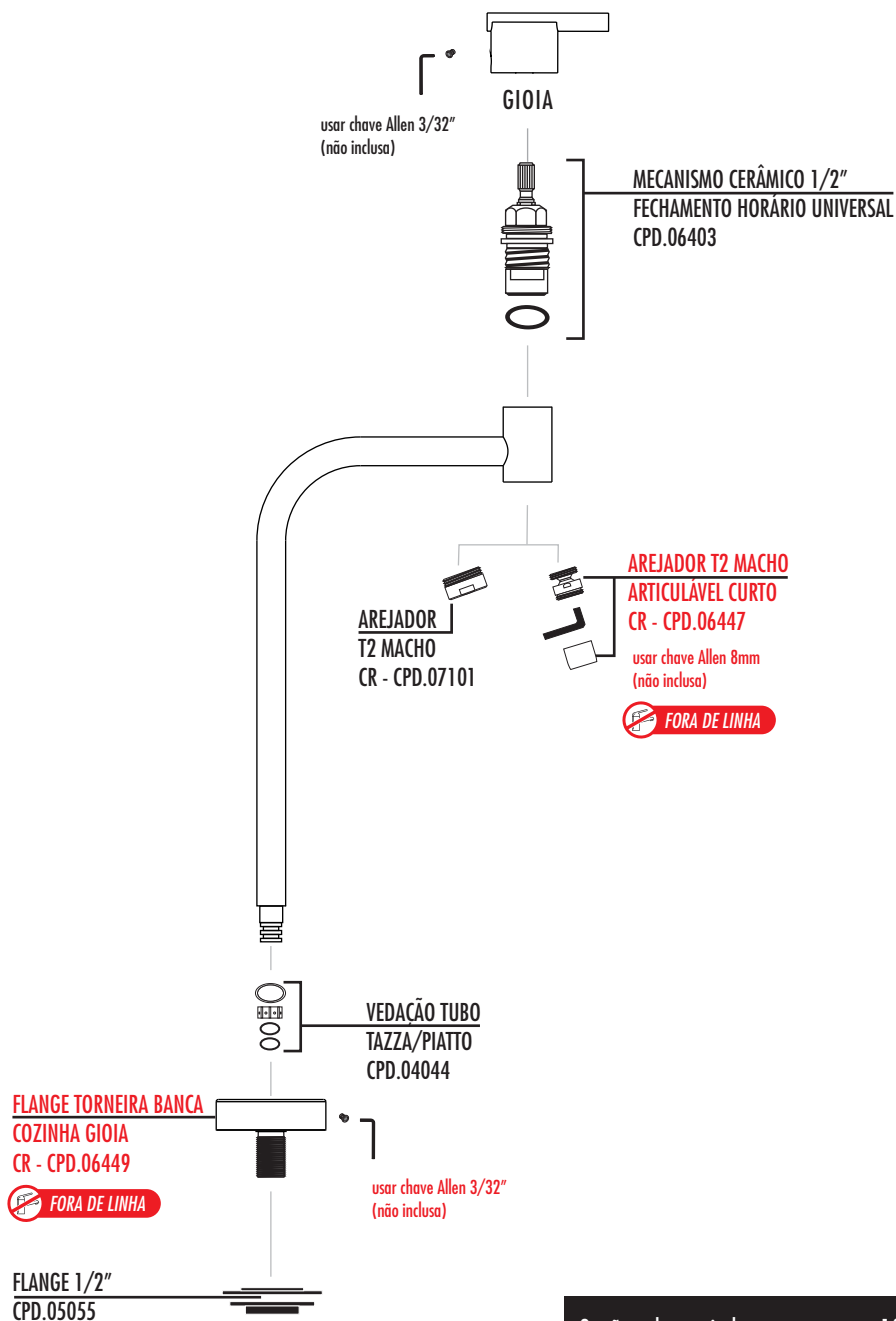

Opções de arejadores ver grupo 10.

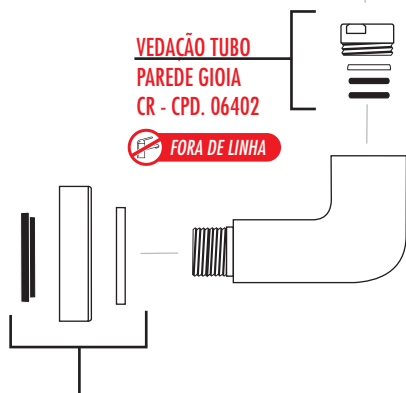
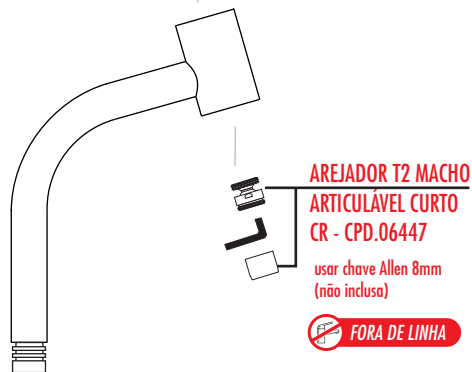
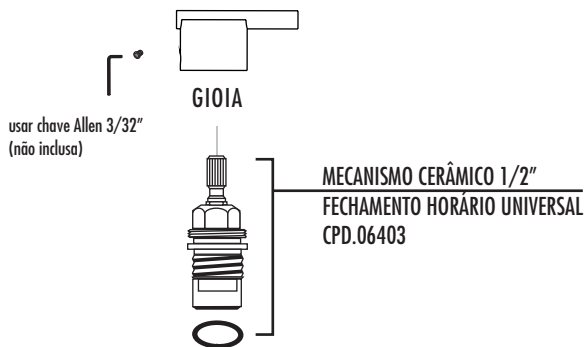

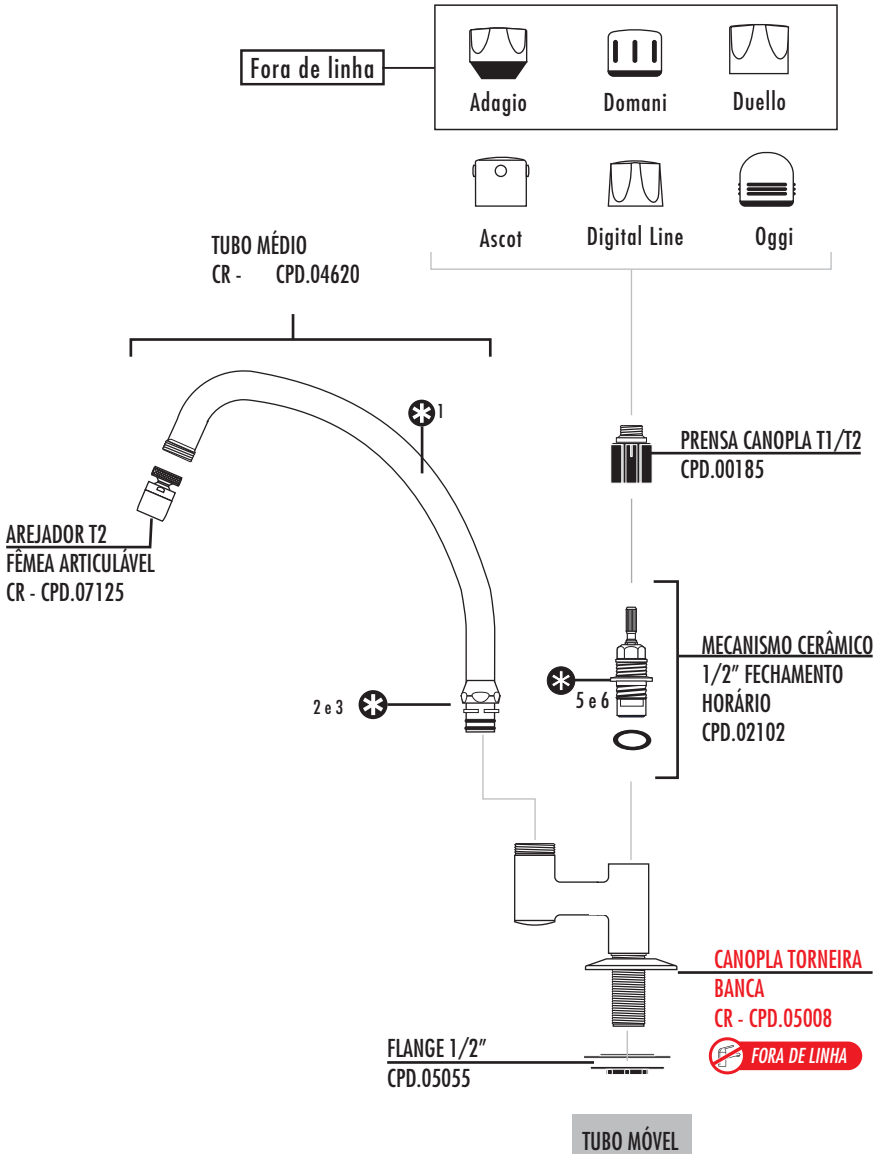

Opções de arejadores ver grupo 10.



Recursos especiais para casos específicos procure nas páginas de detalhamento dos reparos.

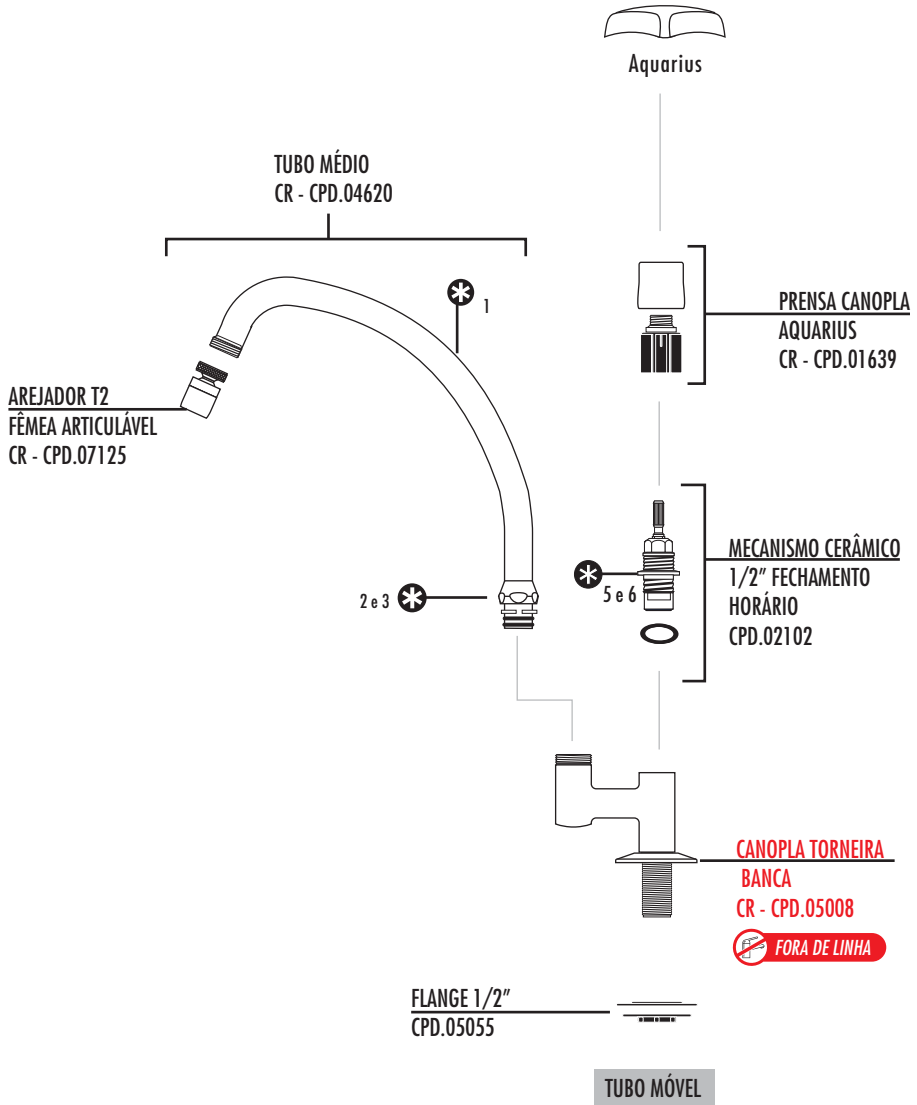

Opções de arejadores ver grupo 10.



Recursos especiais para casos específicos procure nas páginas de detalhamento dos reparos.

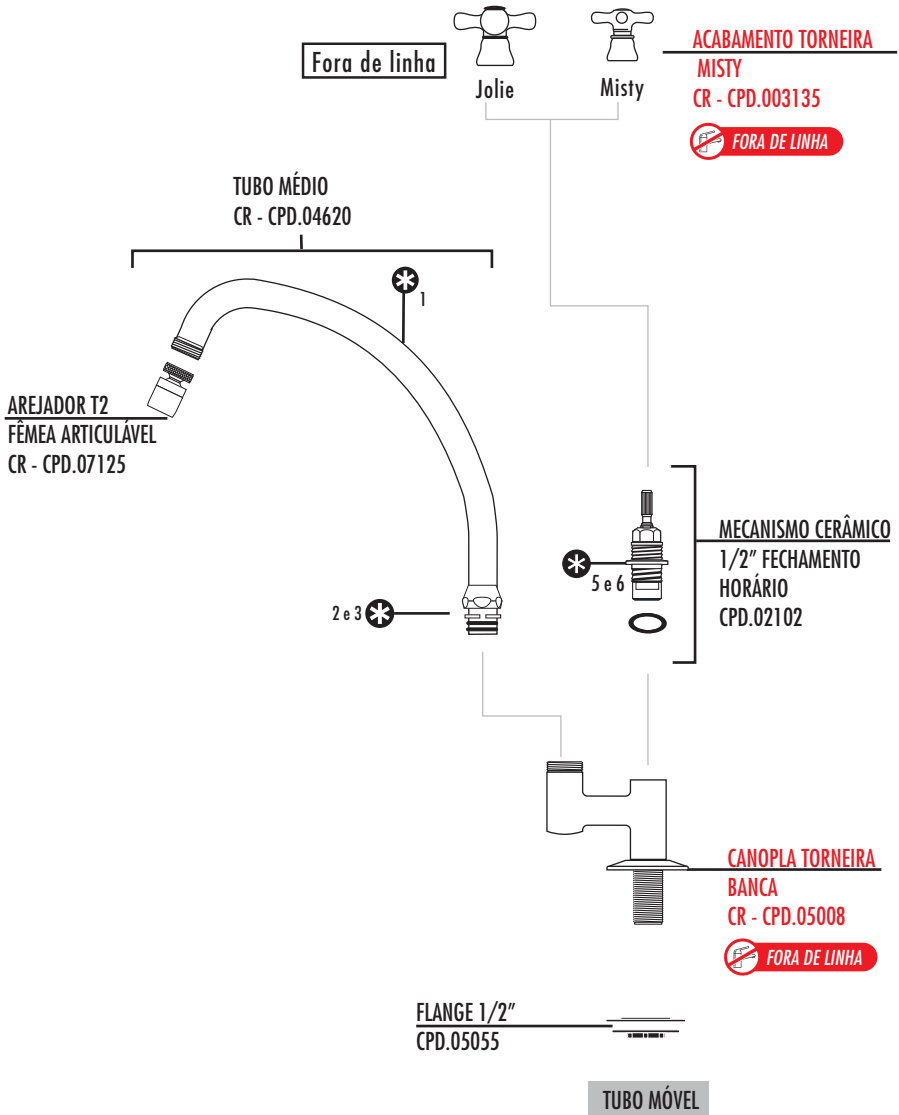

Opções de arejadores ver grupo 10.



Recursos especiais para casos específicos procure nas páginas de detalhamento dos reparos.

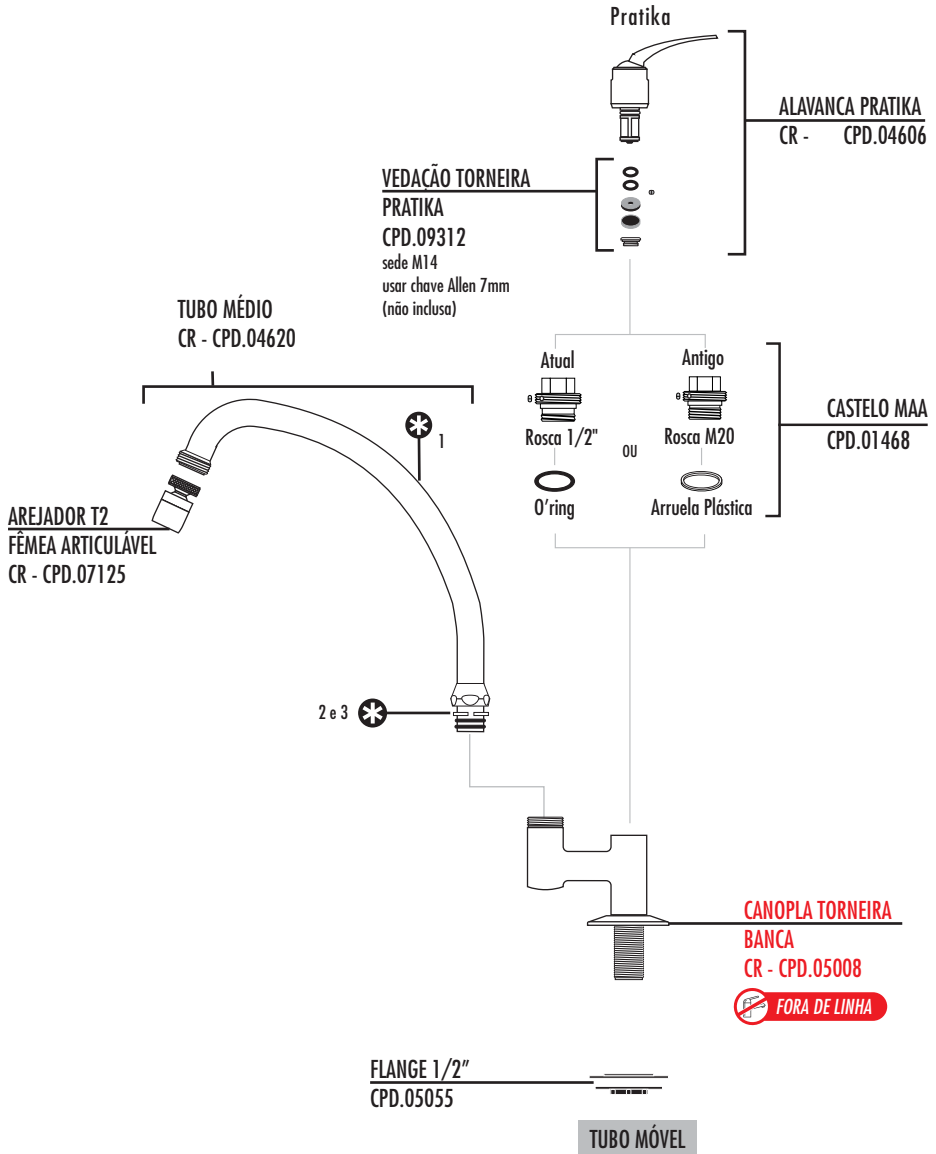

Opções de arejadores ver grupo 10.



Recursos especiais para casos específicos procure nas páginas de detalhamento dos reparos.

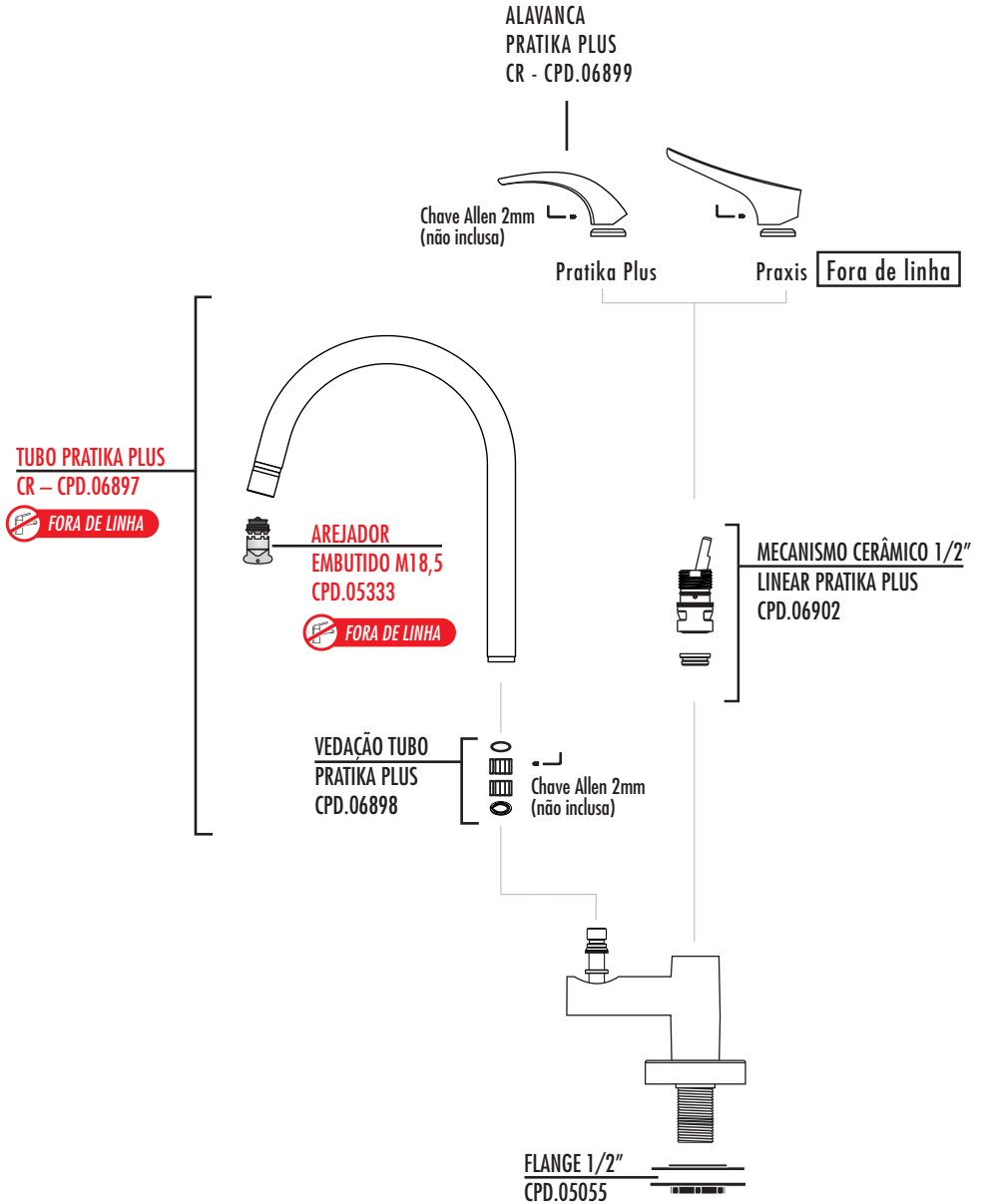

Opções de arejadores ver grupo 10.

CANOPLA TORNEIRA PAREDE
PRATIKA PLUS
CR - CPD.06903

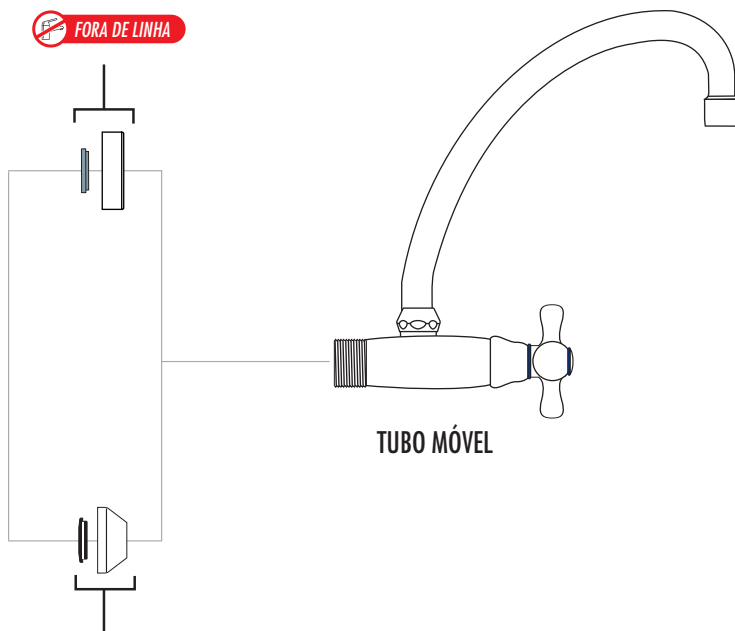

TUBO MÓVEL

CANOPLA TORNEIRA/
MISTURADOR PAREDE
CR - CPD.05040



As torneiras laterais de parede se adaptam as mesmas linhas e recebem os mesmos reparos apresentados para as de banca, com exceção dos reparos acima.

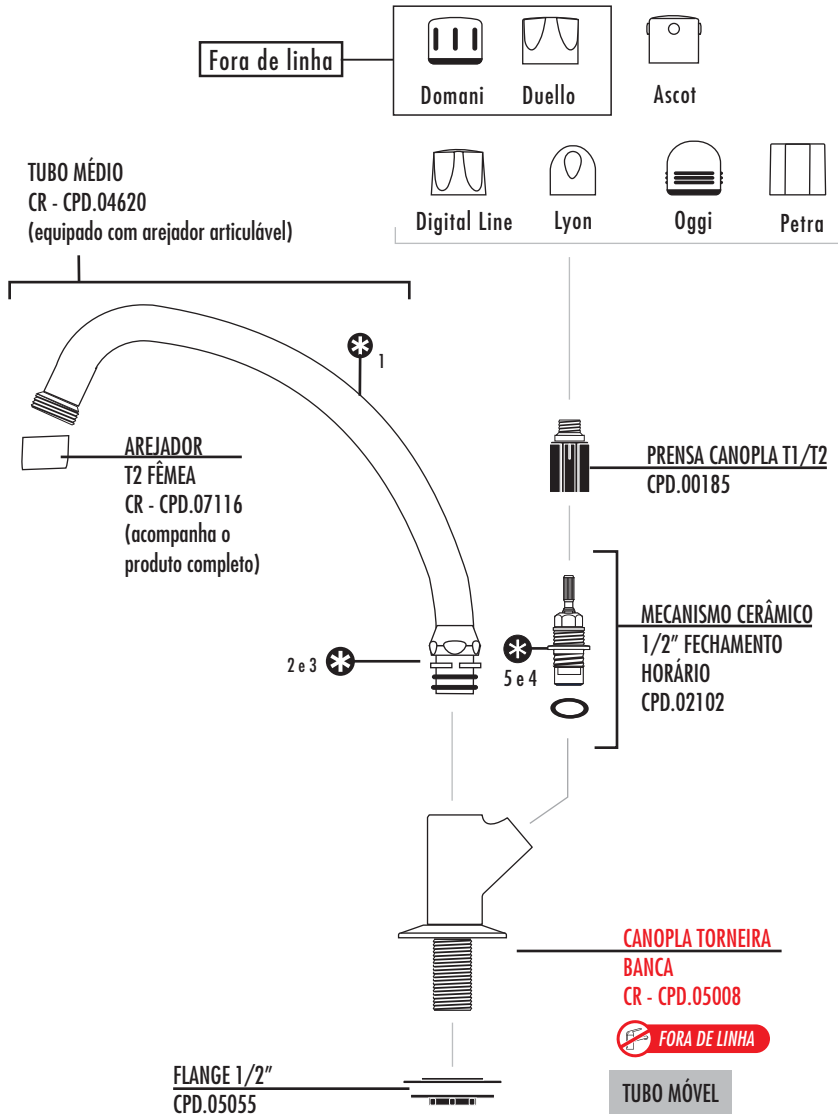

Opções de arejadores ver grupo 10.



Recursos especiais para casos específicos procure nas páginas de detalhamento dos reparos.

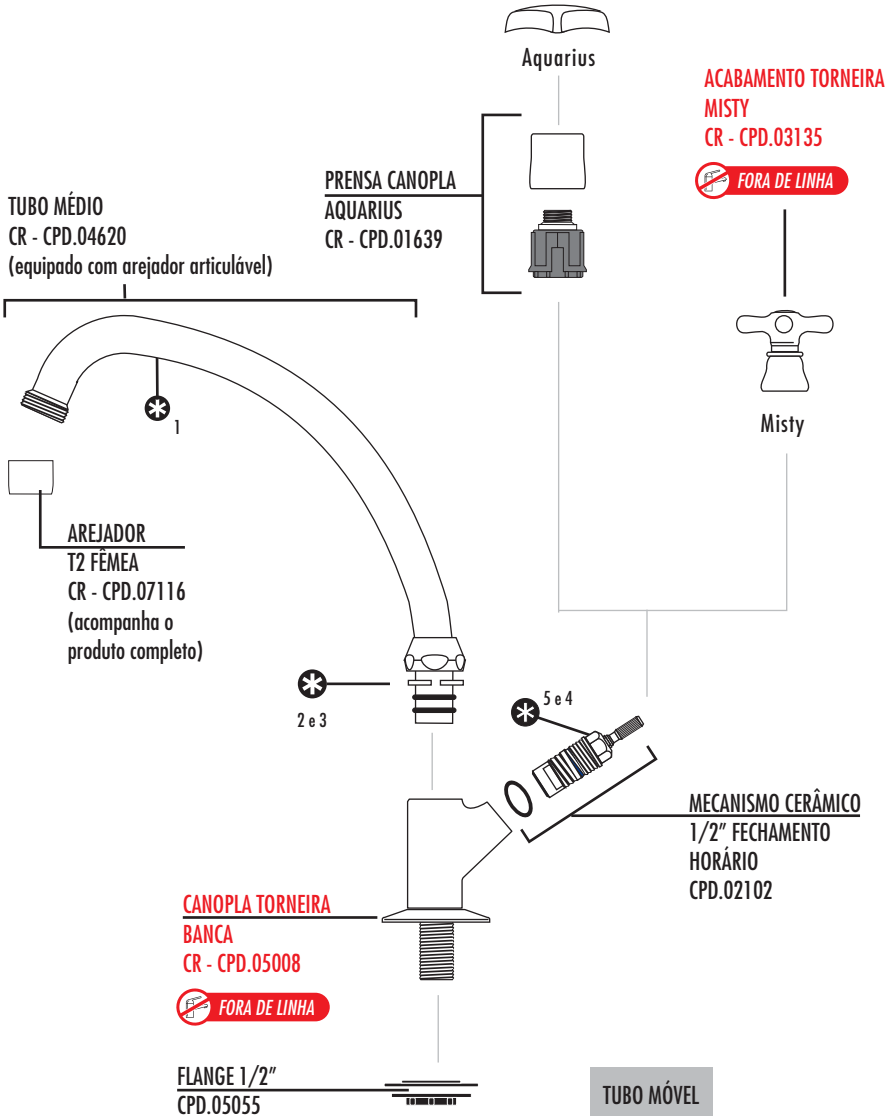

Opções de arejadores ver grupo 10.



Recursos especiais para casos específicos procure nas páginas de detalhamento dos reparos.

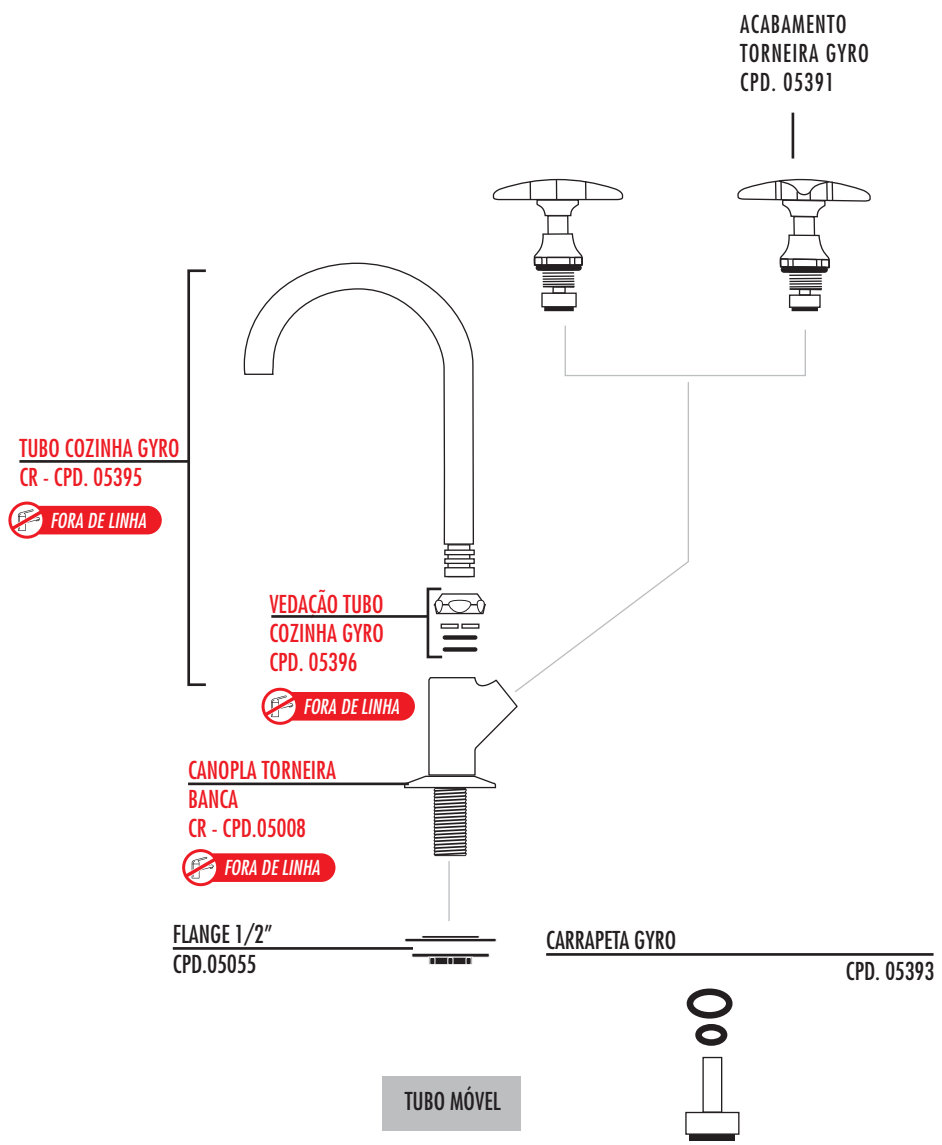

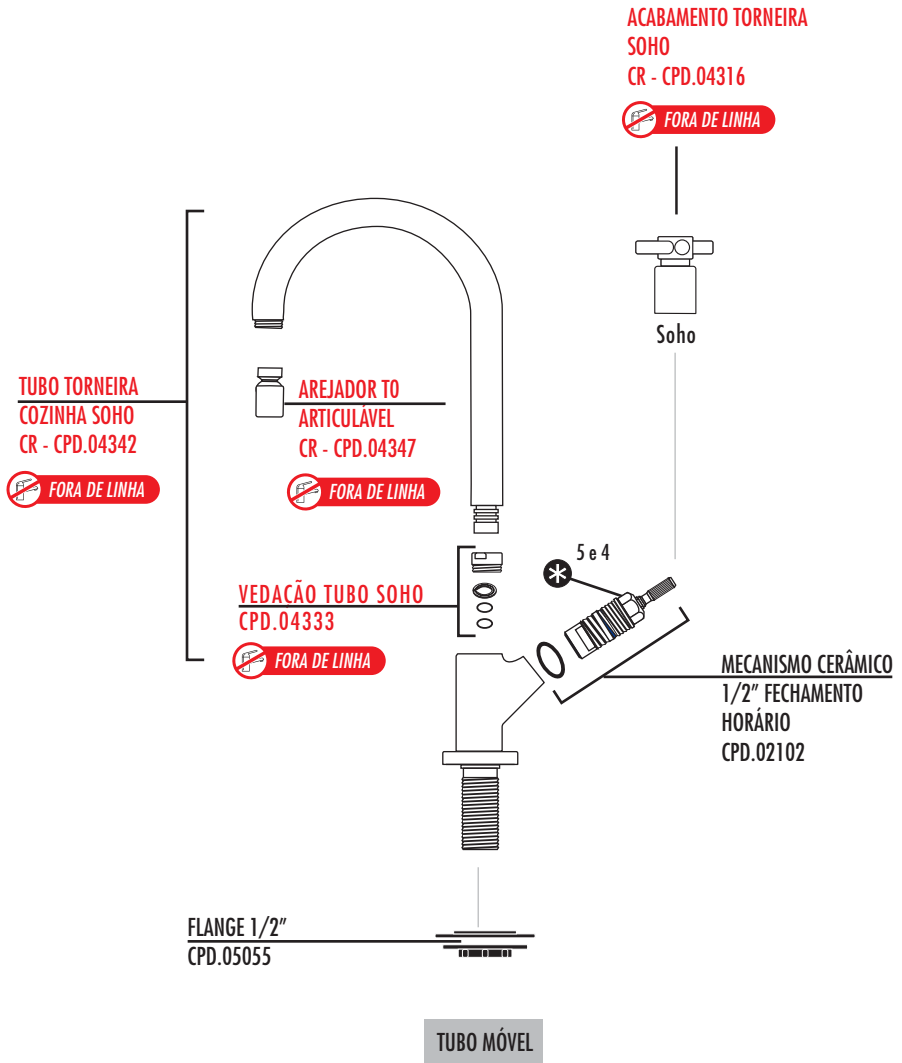

Opções de arejadores ver grupo 10.



Recursos especiais para casos específicos procure nas páginas de detalhamento dos reparos.

Fora de linha

Tazza



Piatto

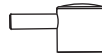

ADAPTADOR VOLANTE ESTRIA
CR - CPD.06958



ACABAMENTO TORNEIRA

PIATTO
CR - CPD.03980



AZUL



VERMELHO



MECANISMO CERÂMICO 1/2"
FECHAMENTO HORÁRIO
CPD.02102

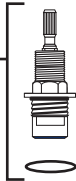

TUBO TAZZA/PIATTO
CR - CPD.04043

FORA DE LINHA

AREJADOR T2 MACHO
ARTICULÁVEL CURTO
CR - CPD.06447

usar chave Allen 8mm
(não inclusa)

FORA DE LINHA

VEDAÇÃO TUBO
TAZZA/PIATTO
CPD.04044

usar chave Allen 3/32"
(não inclusa)

TUBO MÓVEL

FLANGE 1/2"
CPD.05055

Opções de arejadores ver grupo 10.

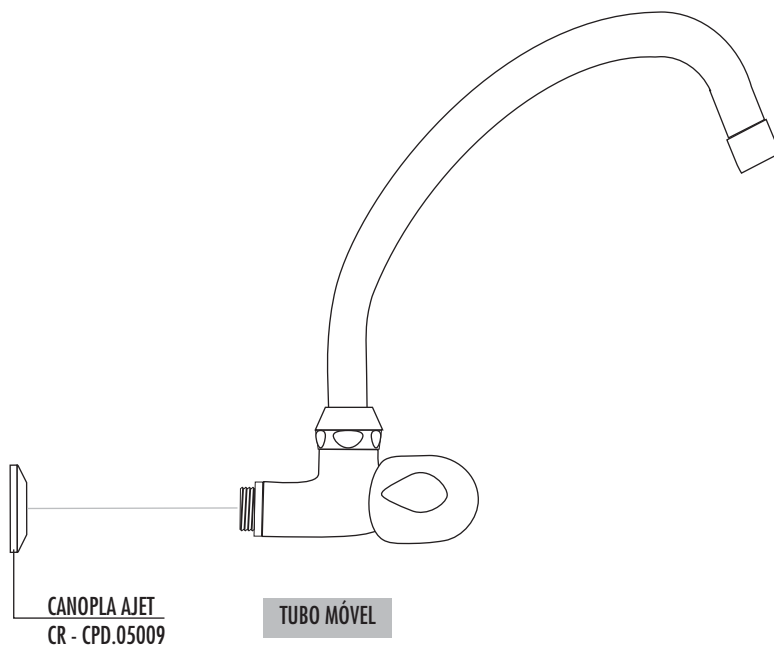

As torneiras laterais de parede se adaptam as mesmas linhas e recebem os mesmos reparos apresentados para as de banca , com exceção dos reparos acima.

DETALHAMENTO DE REPAROS

* 1 TUBO LONGO

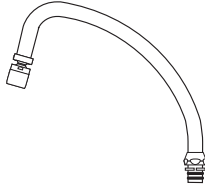

CR - CPD.04621

* 1 BICA LONGA

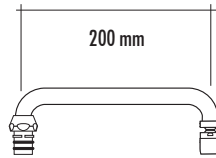

CR - CPD.04619

* 1 TUBO CURTO

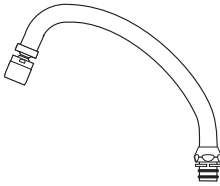

CR - CPD.03153

FORA DE LINHA

* 2 UNIÃO TUBO BICA ANTIGA

CR - CPD.01518

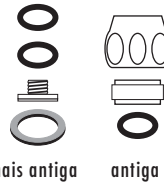

* 3 VEDAÇÃO TUBO BICA DE COZINHA

CPD.04622



* 4 CASTELO REGISTRO LATERAL BASECLIC

CPD.00514

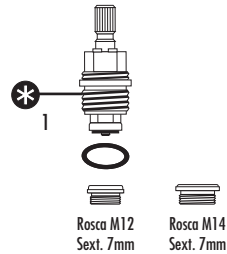

* 5 VEDAÇÃO CASTELOS 1/2", 3/4"

CPD.01109

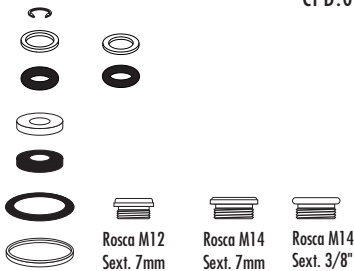

* 6 CASTELO COMPLETO TORNEIRA / MISTURADOR M20

CPD.08473

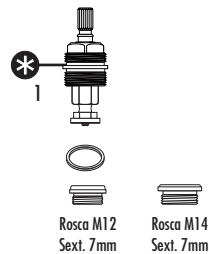

Fora de linha



Ascot



Digital Line



Domani



Duello



Lyon



Oggi

PRENSA CANOPLA T1/T2
CPD.00185

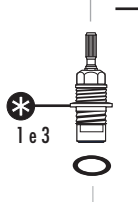

MECANISMO CERÂMICO
1/2" FECHAMENTO
HORÁRIO
CPD.02102

CANOPLA DESLIZANTE
CR - CPD.03999

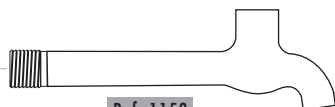

Ref: 1158

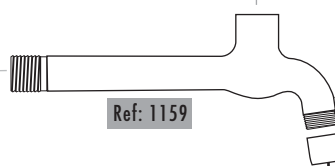

Ref: 1159

AREJADOR
T1 FÊMEA
CR - CPD.02712

Opções de arejadores ver grupo 10.



Recursos especiais para casos específicos procure nas páginas de detalhamento dos reparos.

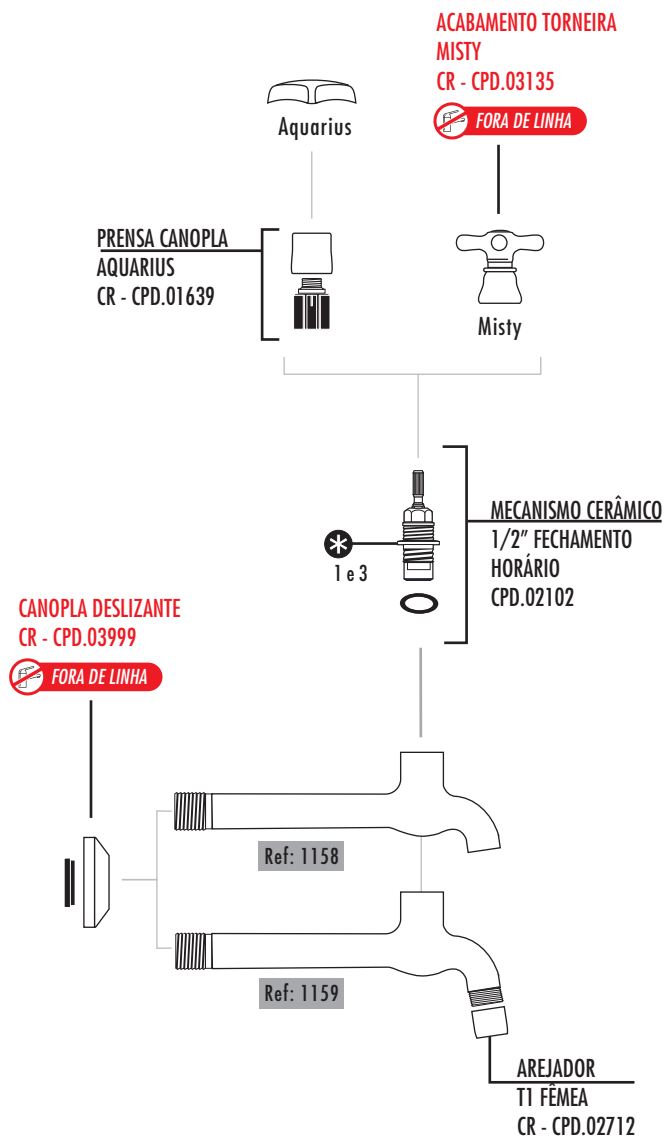

Opções de arejadores ver grupo 10.



Recursos especiais para casos específicos procure nas páginas de detalhamento dos reparos.

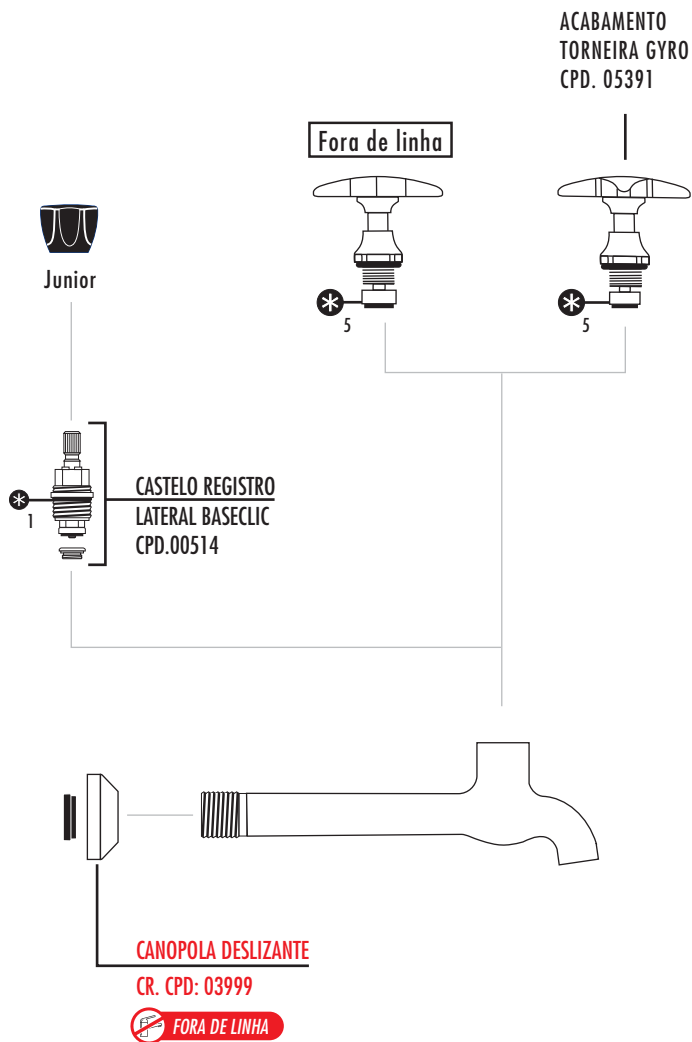

Recursos especiais para casos específicos procure nas páginas de detalhamento dos reparos.

Fora de linha



Ascot



Digital Line



Domani



Lyon



Oggi

PRENSA CANOPLA T1/T2
CPD.00185



MECANISMO CERÂMICO
1/2" FECHAMENTO
HORÁRIO
CPD.02102

CANOPLA DESLIZANTE
CR - CPD.03999



FORA DE LINHA

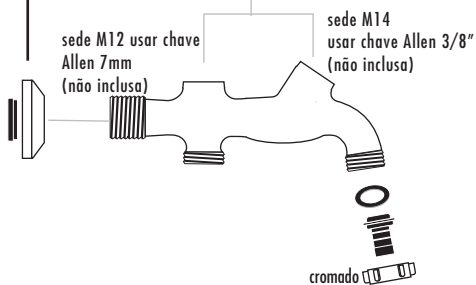

Recursos especiais para casos específicos procure nas páginas de detalhamento dos reparos.

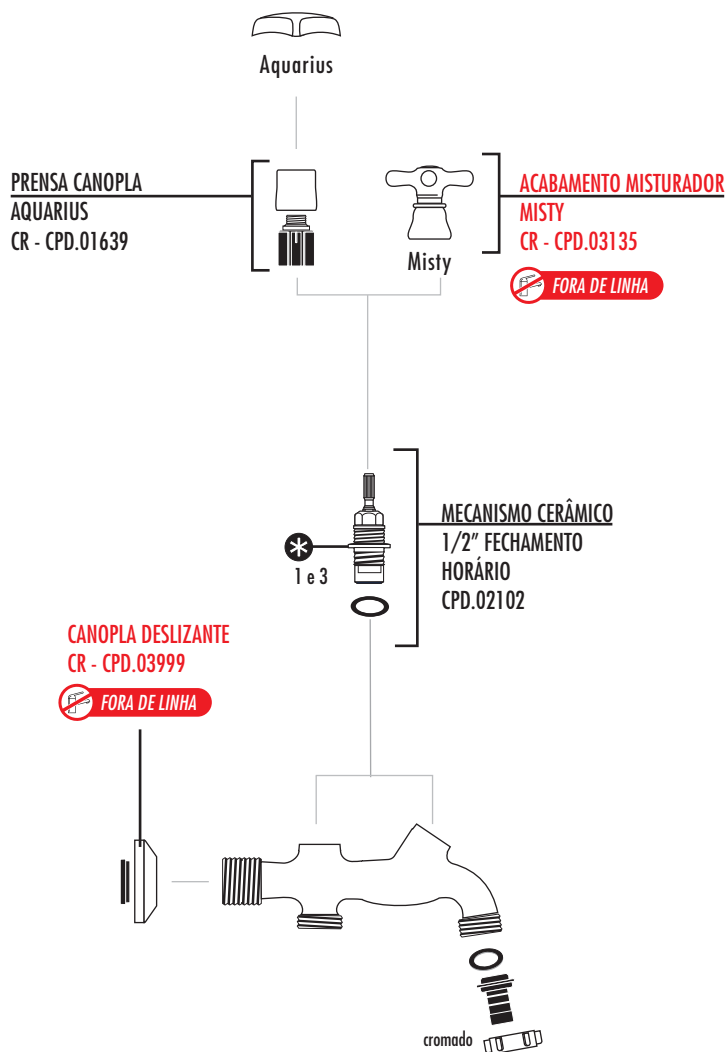

Recursos especiais para casos específicos procure nas páginas de detalhamento dos reparos.

ACABAMENTO
TORNEIRA GYRO
CPD. 05391

Fora de linha

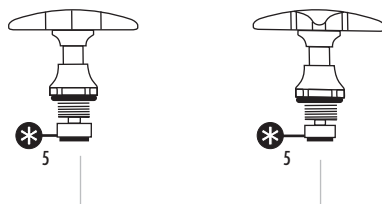

CANOPLA DESLIZANTE
CR - CPD.03999

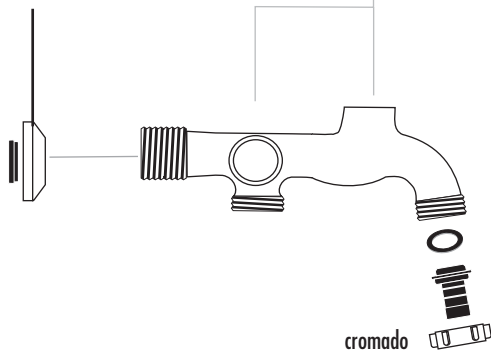

Recursos especiais para casos específicos procure nas páginas de detalhamento dos reparos.

ACABAMENTO
TORNEIRA GYRO
CPD. 05391

Fora de linha

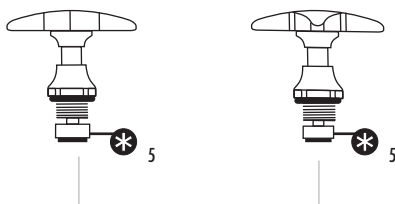
TUBO COZINHA GYRO
CR - CPD. 05395VEDAÇÃO TUBO
COZINHA GYRO
CPD. 05396CANOPLA TORNEIRA
BANCA
CR - CPD.05008FLANGE 1/2"
CPD.05055

TUBO MÓVEL



Recursos especiais para casos específicos procure nas páginas de detalhamento dos reparos.

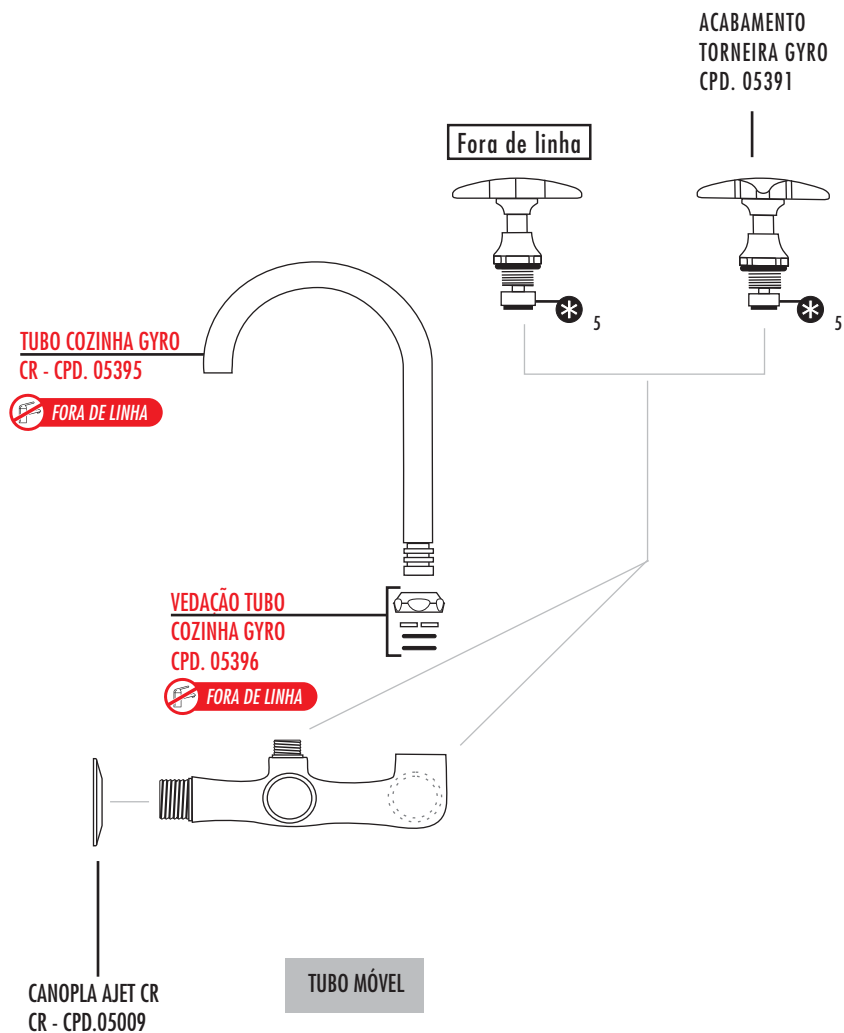

Recursos especiais para casos específicos procure nas páginas de detalhamento dos reparos.

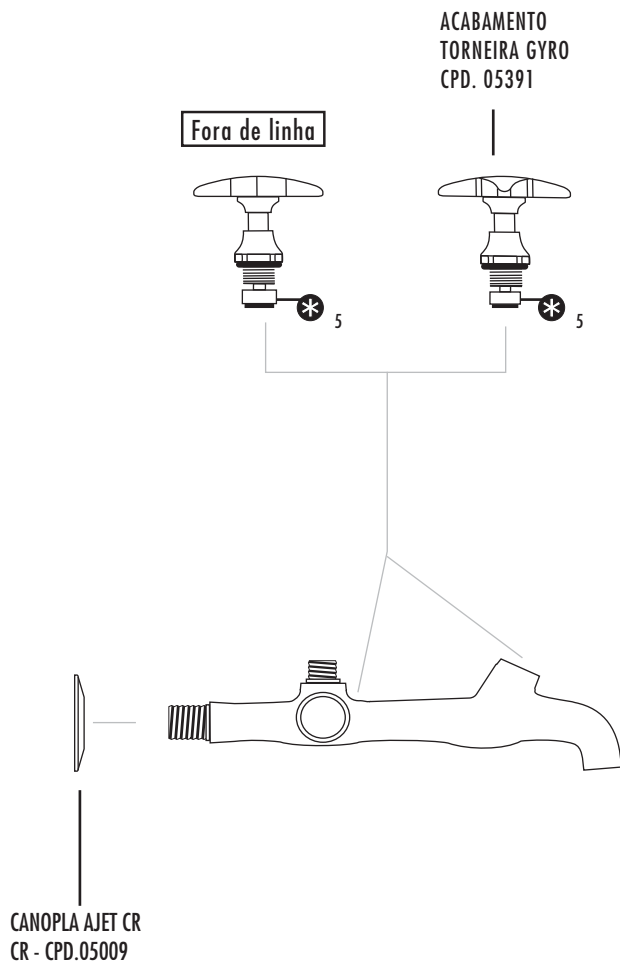

Recursos especiais para casos específicos procure nas páginas de detalhamento dos reparos.

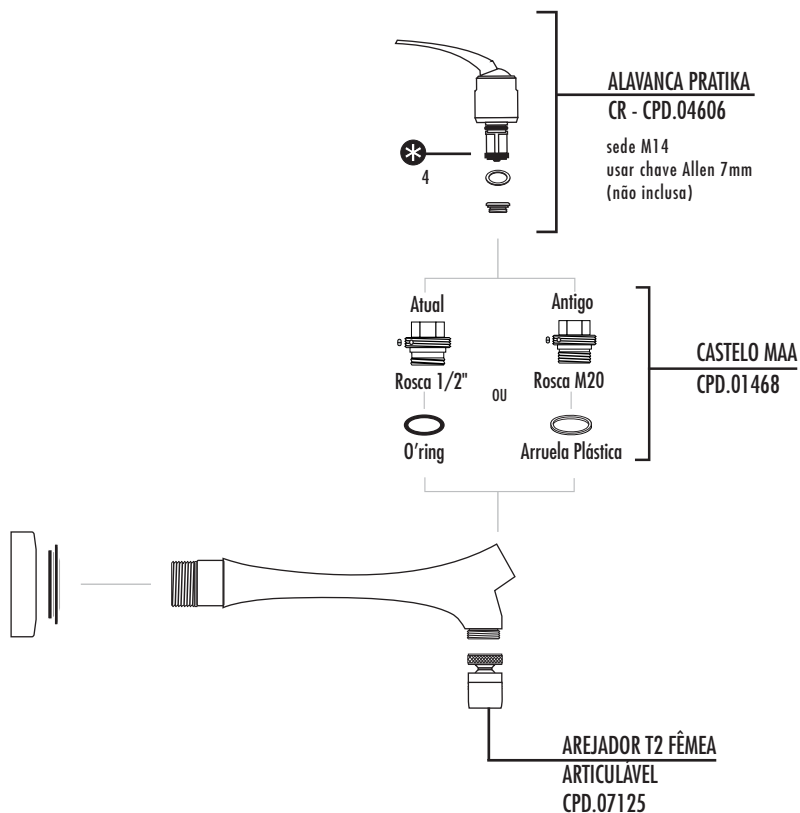

Opções de arejadores ver grupo 10.



Recursos especiais para casos específicos procure nas páginas de detalhamento dos reparos.

Fora de linha



Adagio



Ascot



Digital Line



Lyon



Oggi



Domani

PRENSA CANOPLA T1/T2
CR - CPD.00185

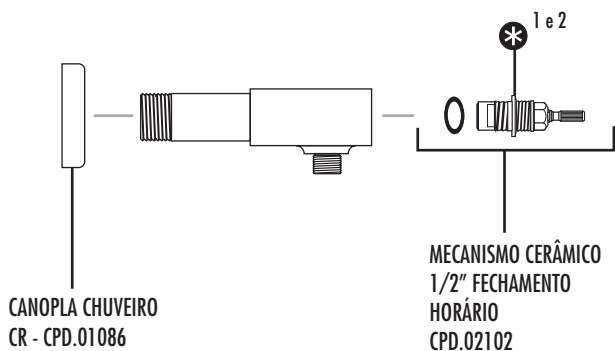

Recursos especiais para casos específicos procure nas páginas de detalhamento dos reparos.

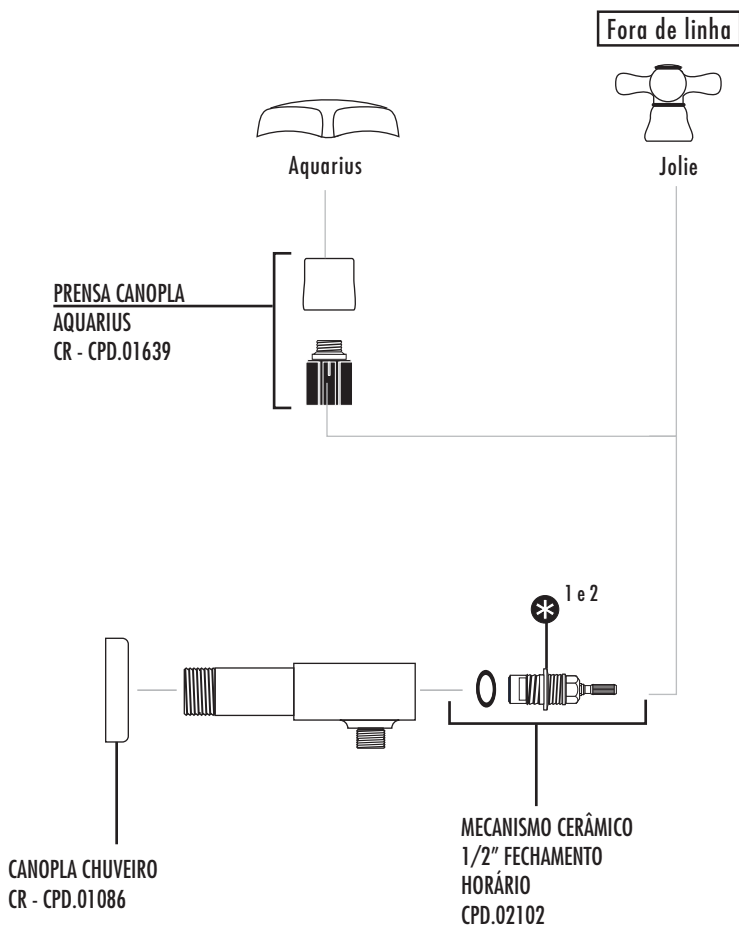

Recursos especiais para casos específicos procure nas páginas de detalhamento dos reparos.

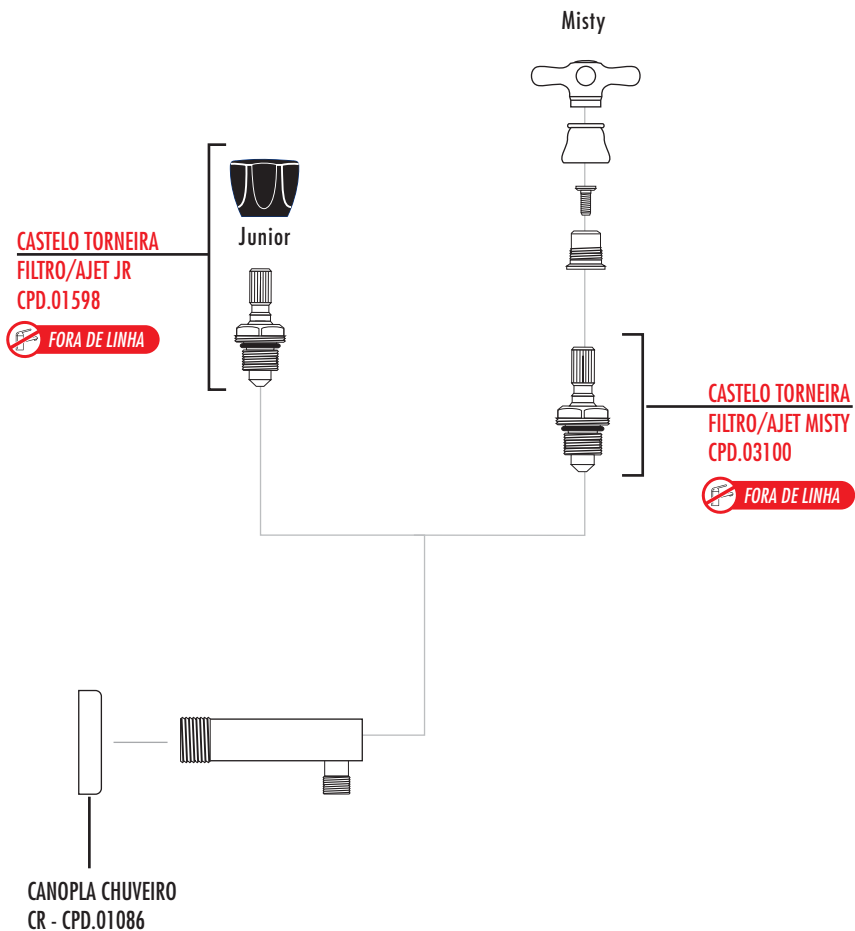

Fora de linha



Aquarius



Adagio



Ascot



Digital Line



Lyon



Oggi



Domani



PRENSA CANOPLA
AQUARIUS
CR - CPD.01639



PRENSA CANOPLA T1/T2
CPD.00185



CASTELO TORNEIRA
TANQUE/JARDIM
CPD.03101

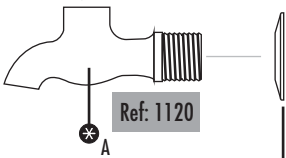

Ref: 1120

A

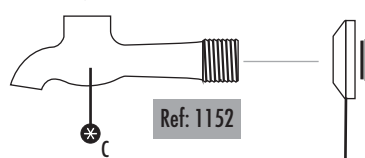

Ref: 1152

C

CANOPLA AJET CR
CR - CPD.05009

CANOPLA DESLIZANTE
CR - CPD.03999

FORA DE LINHA

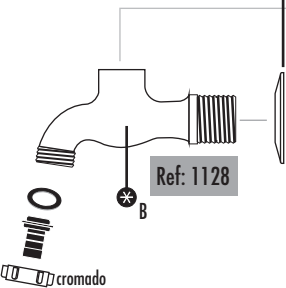

Ref: 1128

B

cromado

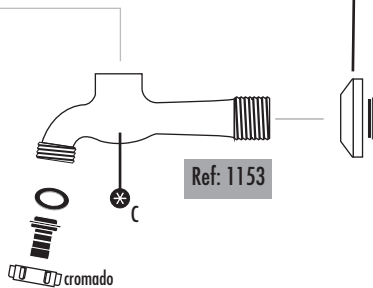

Ref: 1153

C

cromado



A

Torneira
de tanque



B

Torneira de
tanque/jardim



C

Torneira de
tanque/cozinha

CASTELO TORNEIRA JUNIOR
CPD.01596



Misty



CASTELO TORNEIRA
TANQUE/JARDIM
CPD.03101

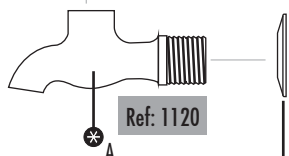

Ref: 1120

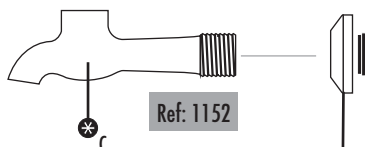

Ref: 1152

CANOPLA AJET CR
CR - CPD.05009

CANOPLA DESLIZANTE
CR - CPD.03999

FORA DE LINHA

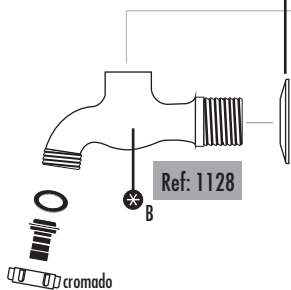

Ref: 1128

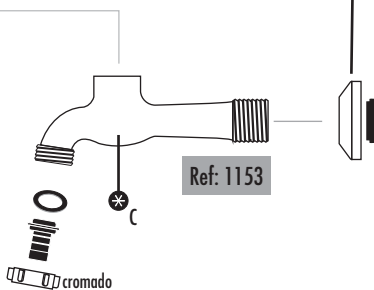

Ref: 1153

Torneira
de tanque

Torneira de
tanque/jardim

Torneira de
tanque/cozinha

ACABAMENTO
TORNEIRA GYRO
CPD. 05391

Fora de linha

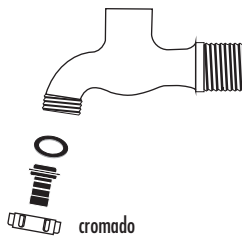
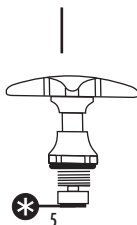

cromado



Recursos especiais para casos específicos procure nas páginas de detalhamento dos reparos.

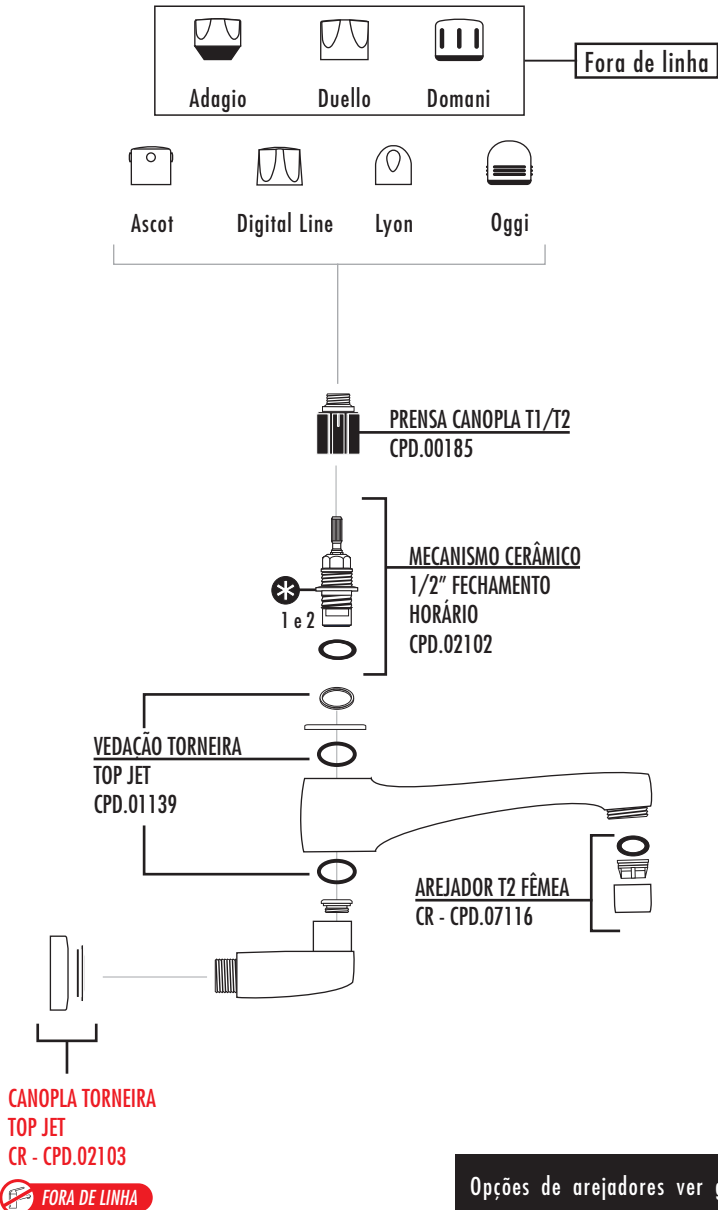

Opções de arejadores ver grupo 10.



Recursos especiais para casos específicos procure nas páginas de detalhamento dos reparos.

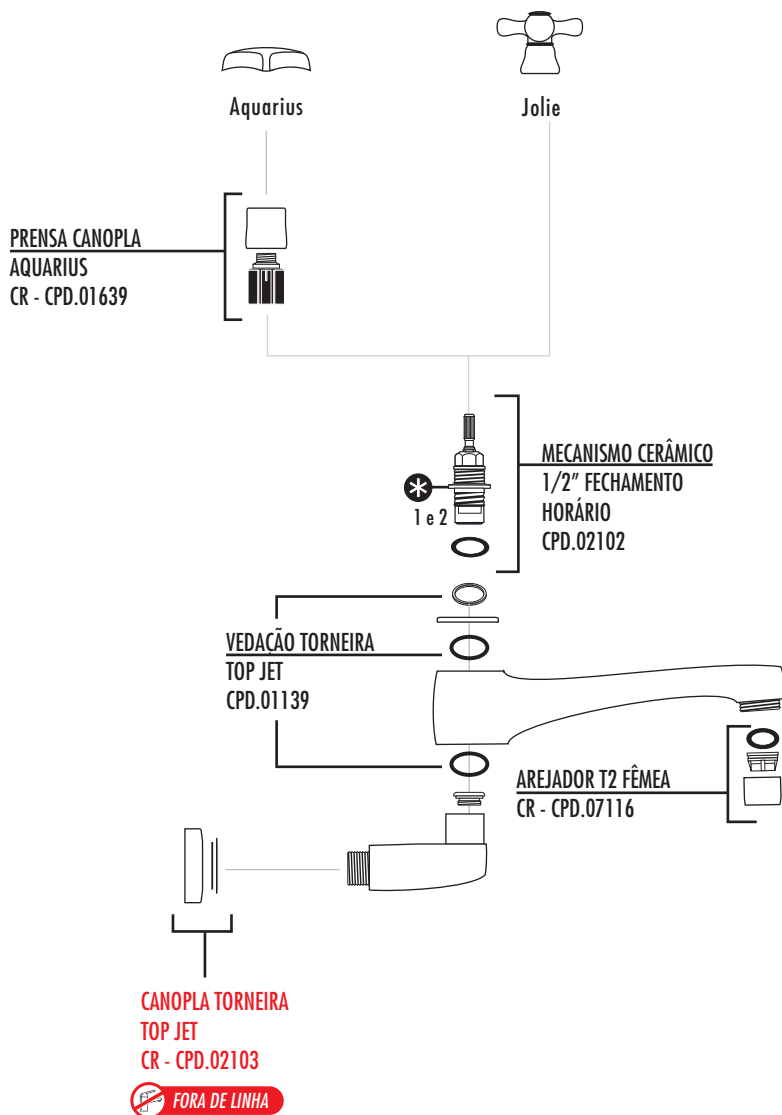

Opções de arejadores ver grupo 10.



Recursos especiais para casos específicos procure nas páginas de detalhamento dos reparos.

DETALHAMENTO DE REPAROS

*₁ VEDAÇÃO CASTELOS 1/2", 3/4" CPD.01109

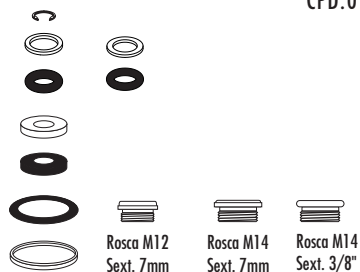

*₂ CASTELO COMPLETO TORNEIRA / MISTURADOR M20 CPD.08473

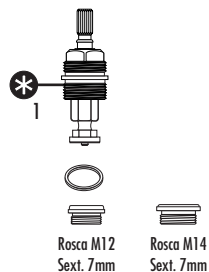

*₃ CASTELO REGISTRO LATERAL BASECLIC CPD.00514

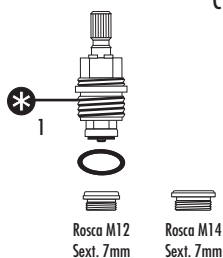

*₄ VEDAÇÃO TORNEIRA PRATIKA CPD.09312

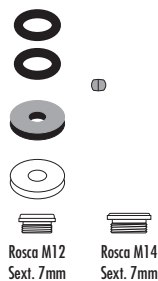

*₅ CARRAPETA GYRO CPD.05393



*₆ CARRAPETA TORNEIRA TANQUE JARDIM CPD.05394



MANDACHUVA

Página 5.01

VERANO

Página 5.02

RELAX

Página 5.03

IPANEMA E LEBLON

Página 5.04

ACQUACLEAN

Página 5.05

PICOLLO LIGHT

Página 5.06

JOLIE

Página 5.07

GERIBÁ

Página 5.08

VISCAYA

Página 5.09

DETALHAMENTO DE REPAROS

Página 5.10

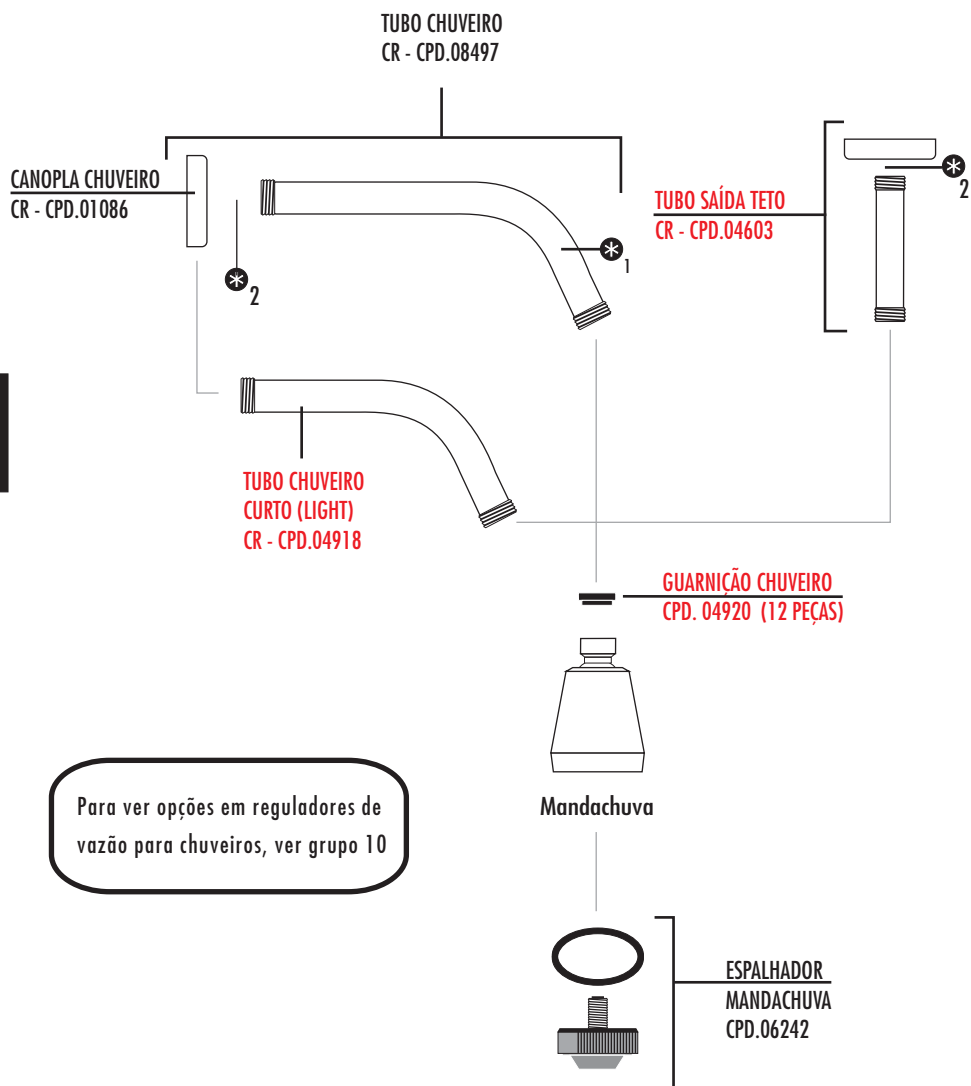

Para ver opções em reguladores de vazão para chuveiros, ver grupo 10



Recursos especiais para casos específicos procure nas páginas de detalhamento dos reparos.

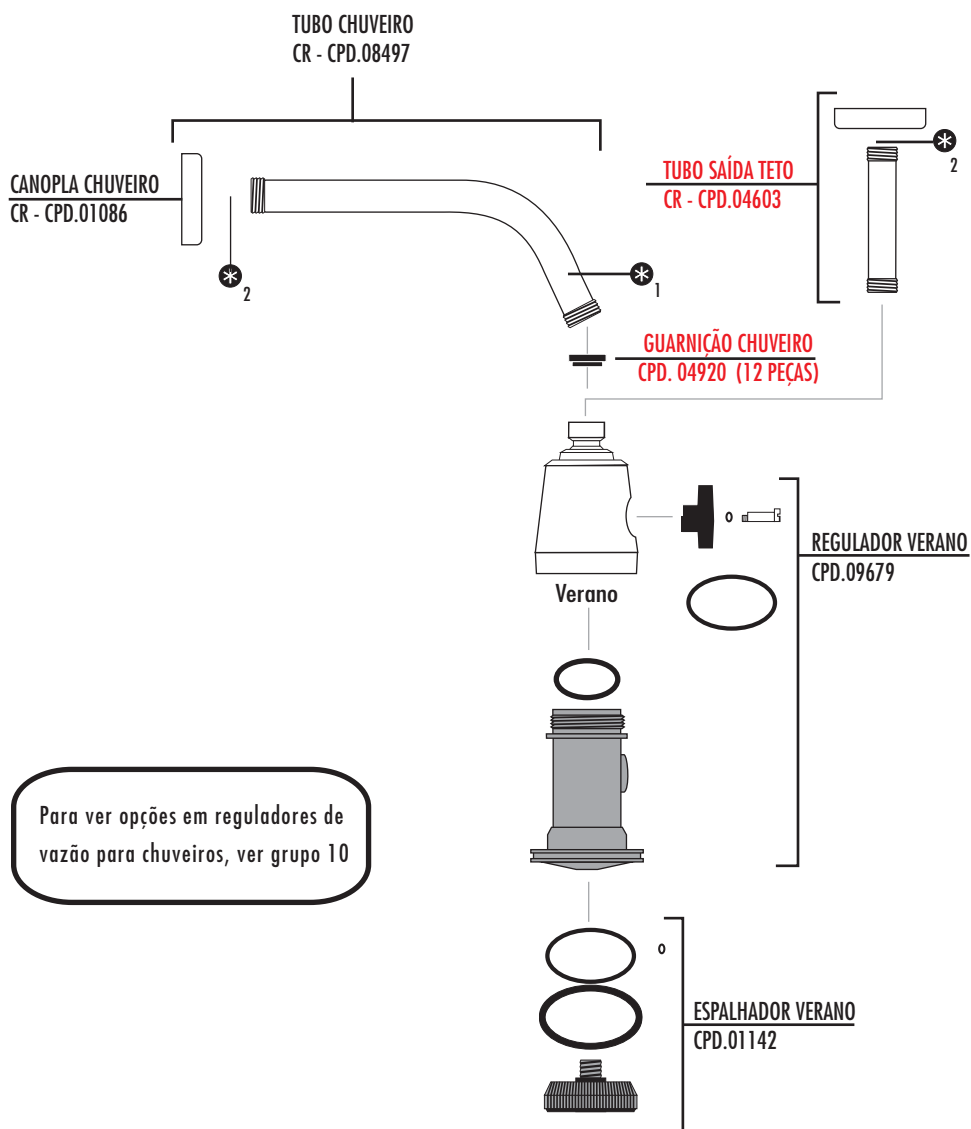

Recursos especiais para casos específicos procure nas páginas de detalhamento dos reparos.

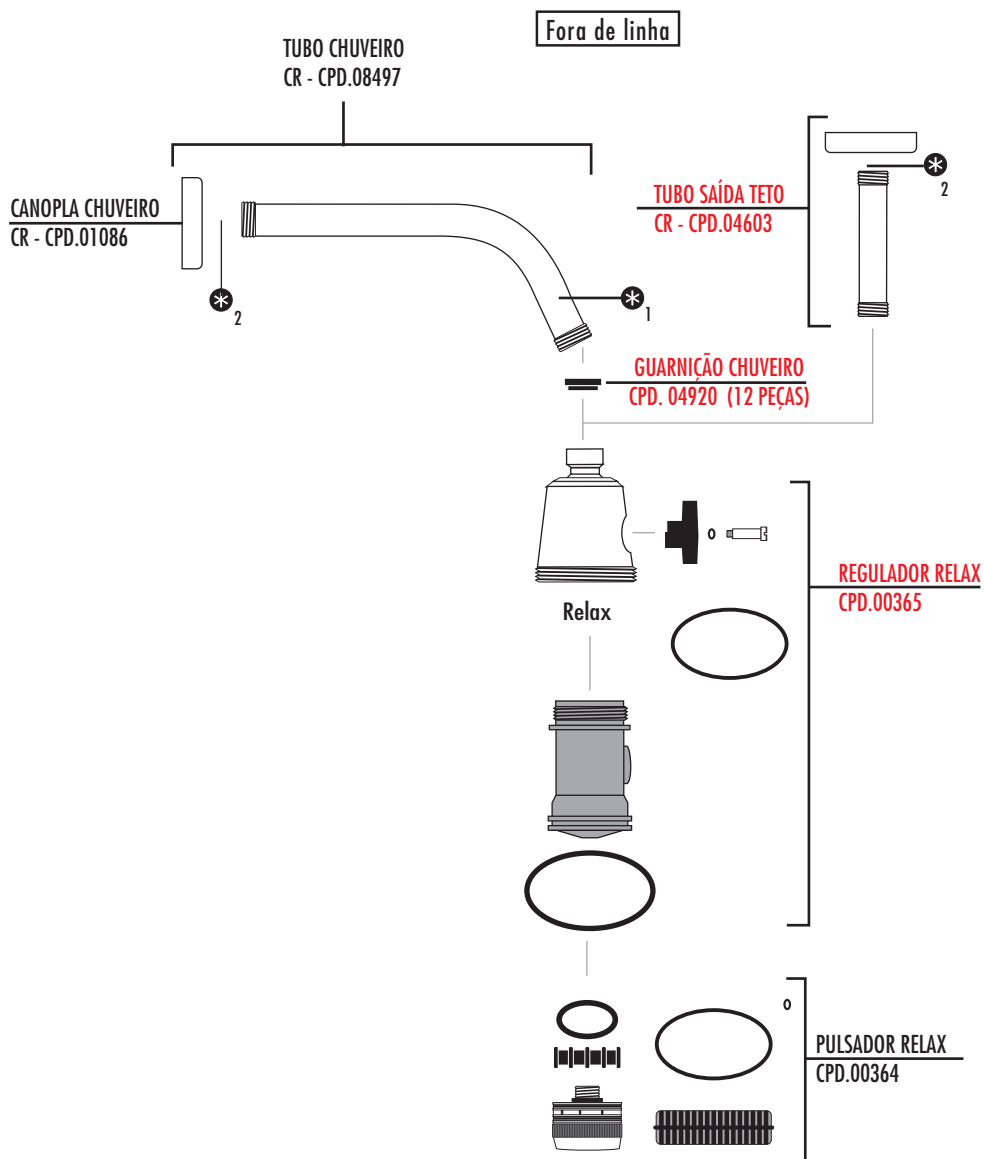

Recursos especiais para casos específicos procure nas páginas de detalhamento dos reparos.

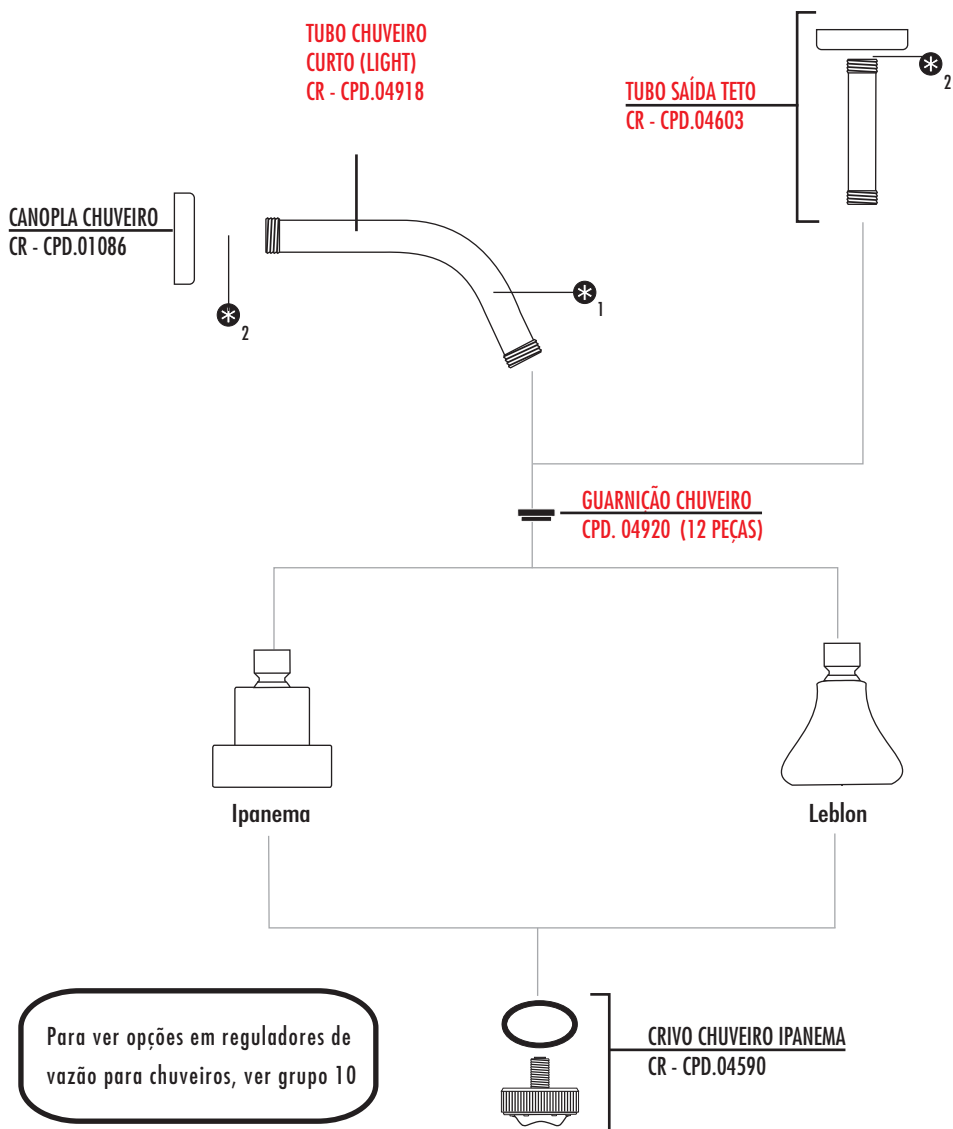

Recursos especiais para casos específicos procure nas páginas de detalhamento dos reparos.

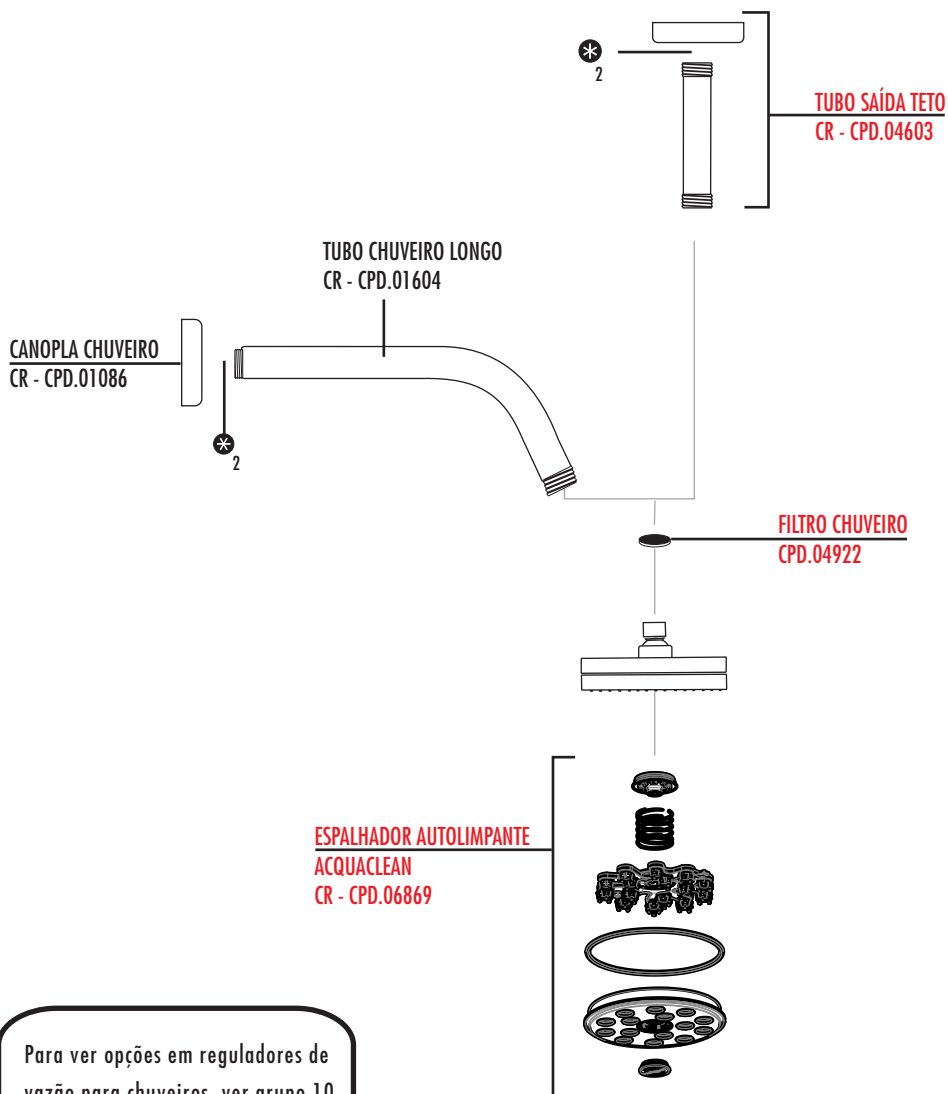

Para ver opções em reguladores de vazão para chuveiros, ver grupo 10



Recursos especiais para casos específicos procure nas páginas de detalhamento dos reparos.

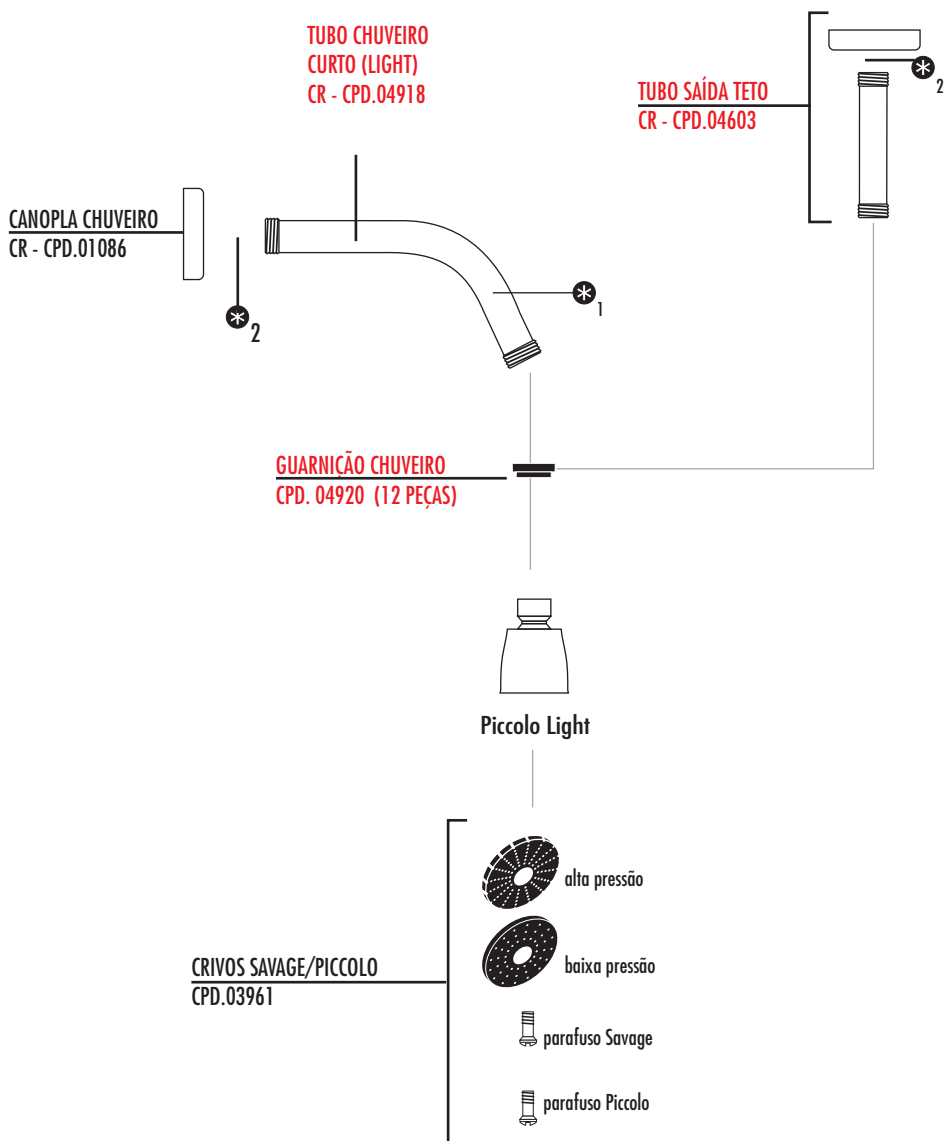

Recursos especiais para casos específicos procure nas páginas de detalhamento dos reparos.

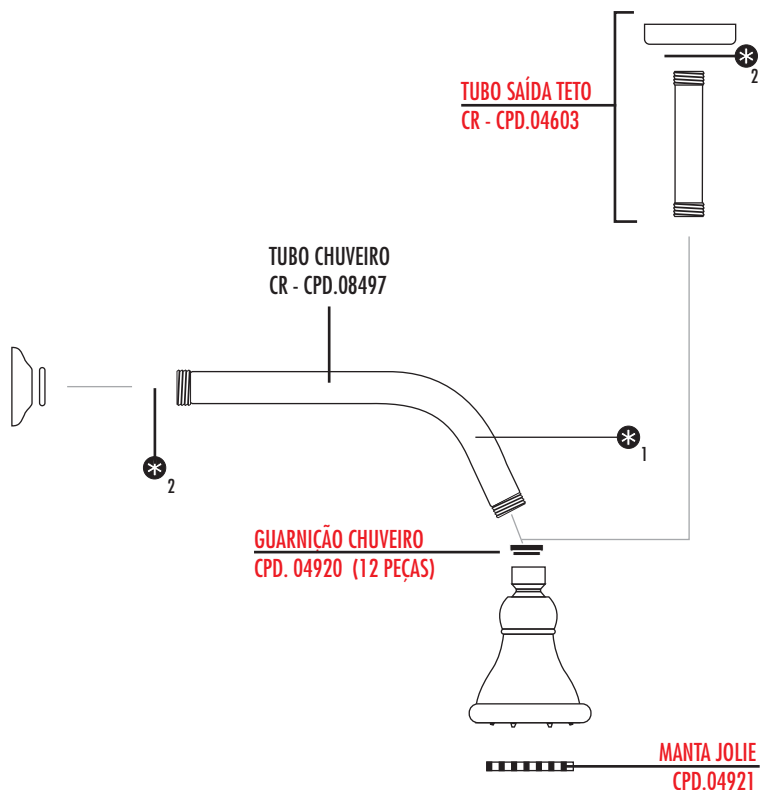

Para ver opções em reguladores de vazão para chuveiros, ver grupo 10



Recursos especiais para casos específicos procure nas páginas de detalhamento dos reparos.

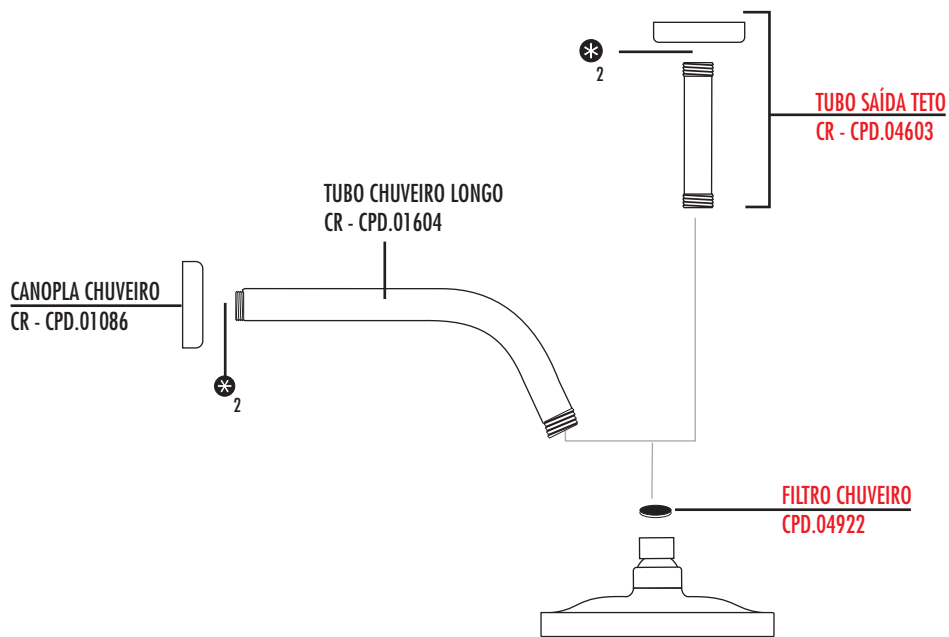

Recursos especiais para casos específicos procure nas páginas de detalhamento dos reparos.

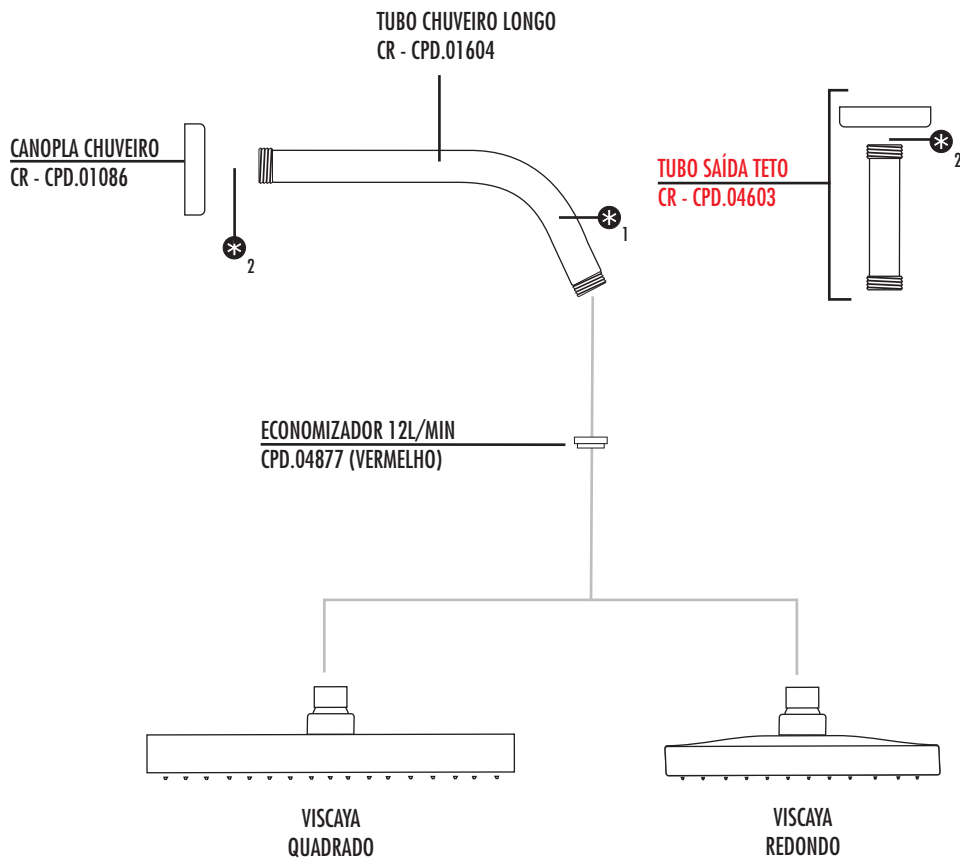

Para ver opções em reguladores de vazão para chuveiros, ver grupo 10



Recursos especiais para casos específicos procure nas páginas de detalhamento dos reparos.

DETALHAMENTO DE REPAROS

*₁ TUBO CHUVEIRO LONGO
 CR - CPD.01604

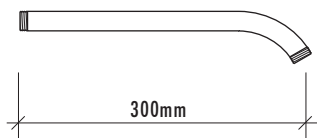

*₂ SALVA CHUVEIRO 1/2"
 CPD.00009

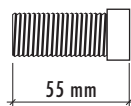

*₃ TUBO SAÍDA DE TETO REDONDO
 200 CR-CPD.06088
 300 CR-CPD.06089

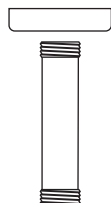

DUCHAS PARA BOX COM DESVIADOR

Página 6.01

DUCHAS PARA BOX COM SAÍDA DE PAREDE

Página 6.04

DETALHAMENTO DE REPAROS

Páginas 6.07 e 6.08

DUCHAS AJET

Página 6.09

DUCHAS AJET PARA CAIXA ACOPLADA

Página 6.20

DETALHAMENTO DE REPAROS

Página 6.28

DUCHAS AJET PARA LAVATÓRIO

Página 6.28

Fora de linha

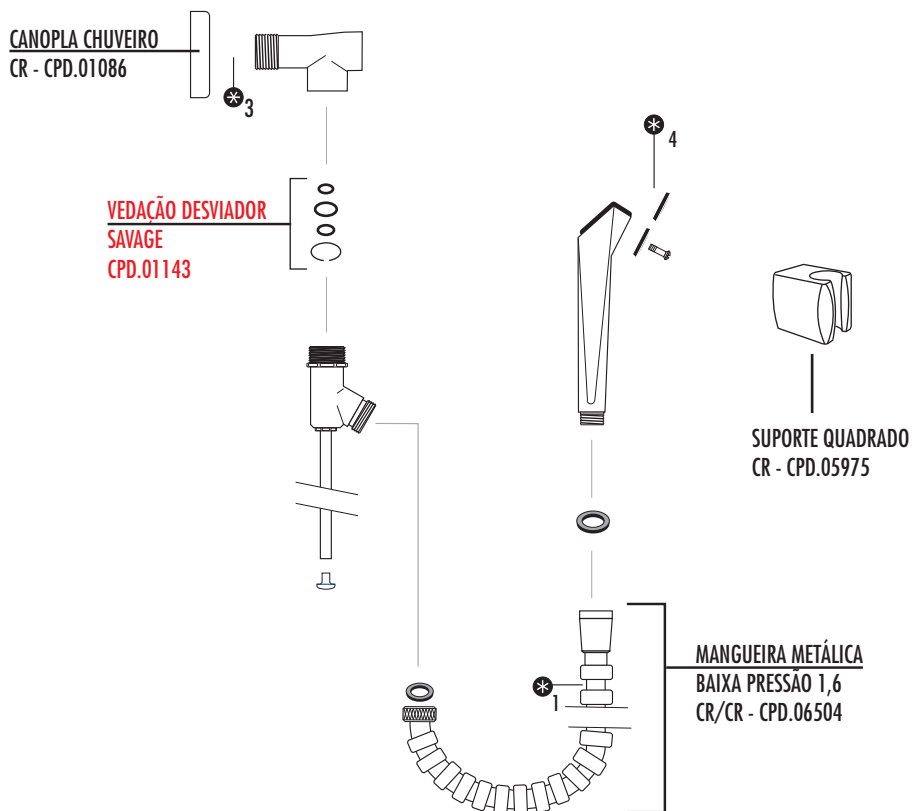

Recursos especiais para casos específicos procure nas páginas de detalhamento dos reparos.

* Não recomendamos o uso deste produto ligado com aquecedores de passagem elétrico ou à gás.

* De acordo com as Normas Brasileiras, não é recomendado o uso de produtos equipados com mangueiras metálicas, ligados a aquecedores elétricos de passagem.

PUNHOS:
tabela de produtos

PUNHO REGATTA
CR - CPD.03070

PUNHO STAR
CR - CPD.03091

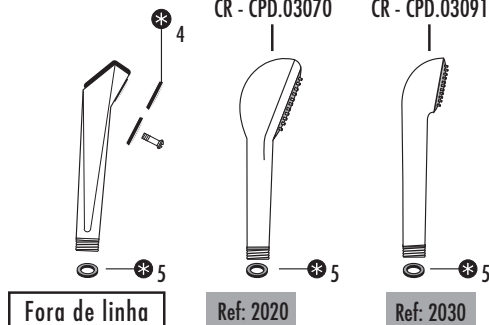

CANOPLA CHUVEIRO
CR - CPD.01086



SUPORTE QUADRADO
CR - CPD.05975

DESVIADOR DUCHA
MANUAL
CR - CPD.01861

DESVIADOR INFERIOR
DUCHA MANUAL
CR - CPD.06443

MANGUEIRA METÁLICA
BAIXA PRESSÃO 1,6
CR/CR - CPD.06504

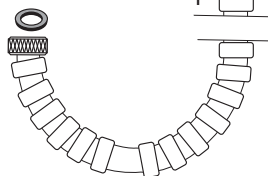

Recursos especiais para casos específicos procure nas páginas de detalhamento dos reparos.

Fora de linha

* Não recomendamos o uso deste produto ligado com aquecedores de passagem elétrico ou à gás.

* De acordo com as Normas Brasileiras, não é recomendado o uso de produtos equipados com mangueiras metálicas, ligados a aquecedores elétricos de passagem.

PUNHO LUNA
CR - CPD.06432
(So consulta)



FILTRO CHUVEIRO
CPD.04922

CANOPLA VITRA
CR - CPD.06111
(Substitui a canopla fornecida com a saída de parede).

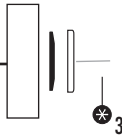

*3

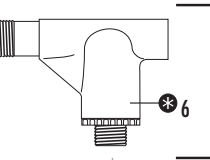

*6

DESVIADOR DUCHA
MANUAL
CR - CPD.01861

Ref: 2000

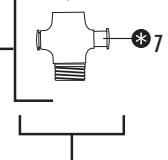

*7

DESVIADOR INFERIOR
DUCHA MANUAL
CR - CPD.06443

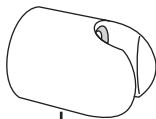

SUPORTE SIMETRIA
CR - CPD.06200

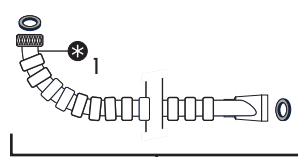

*1

MANGUEIRA METÁLICA
BAIXA PRESSÃO 1,6
CR/CR - CPD.06504



Recursos especiais para casos específicos procure nas páginas de detalhamento dos reparos.

PUNHOS:
tabela de produtos



SUPORE QUADRADO
CR - CPD.05975

Fora de linha



PUNHO REGATTA
CR - CPD.03070



PUNHO STAR
CR - CPD.03091

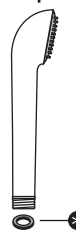

SAÍDA DE PAREDE
CR - CPD.01896

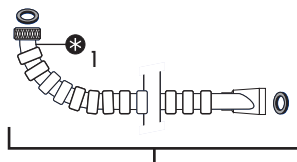
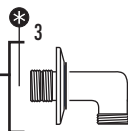

MANGUEIRA METÁLICA
BAIXA PRESSÃO 1,6
CR/CR - CPD.06504



Recursos especiais para casos específicos procure nas páginas de detalhamento dos reparos.

Fora de linha

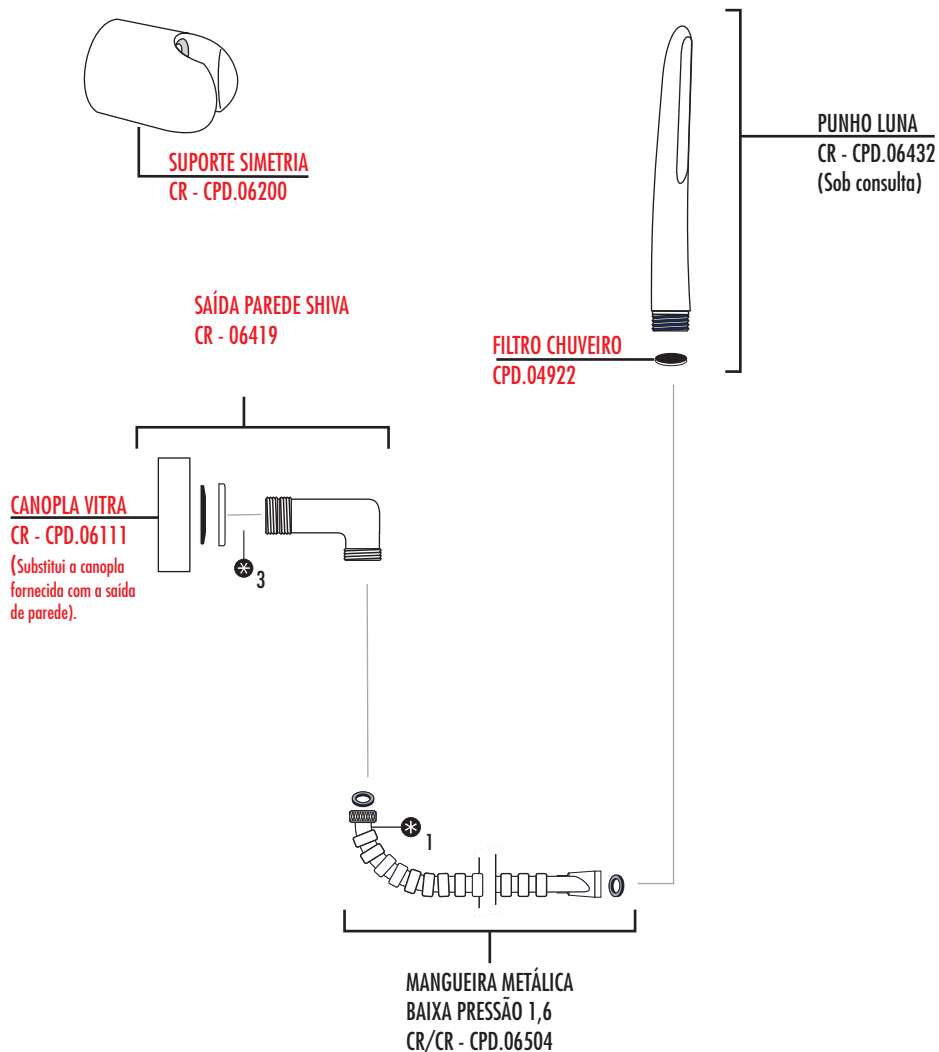

Recursos especiais para casos específicos procure nas páginas de detalhamento dos reparos.

Fora de linha

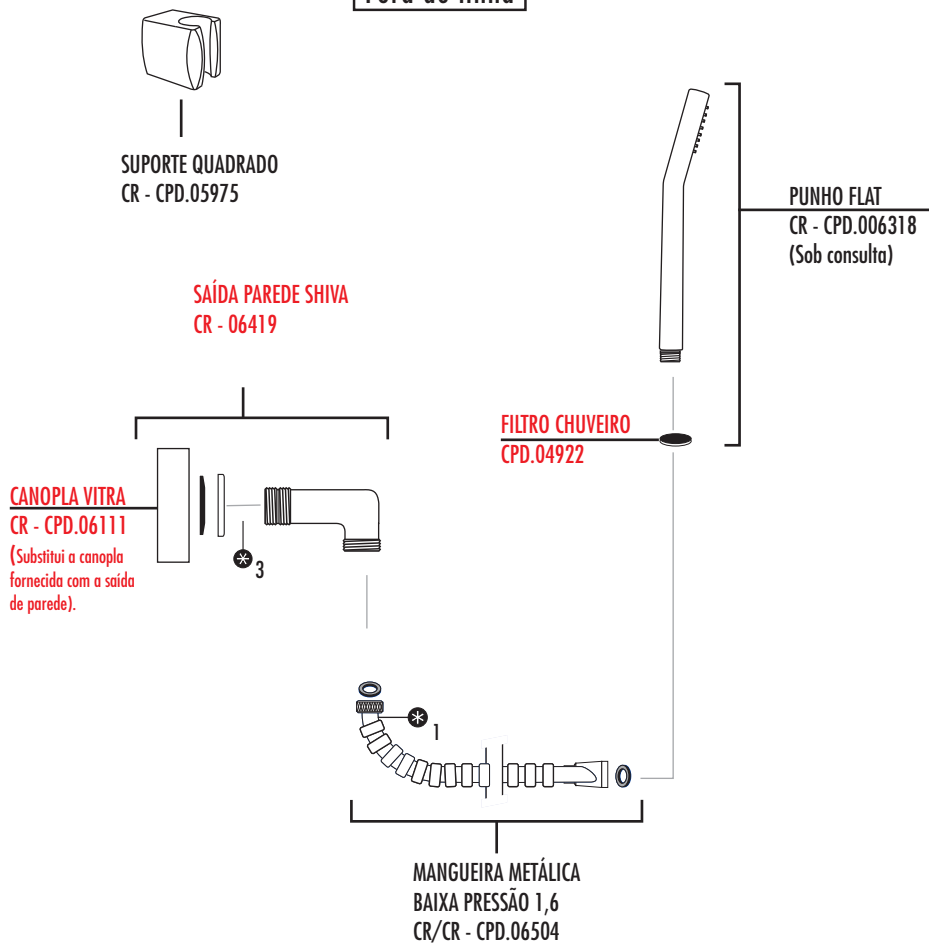

Recursos especiais para casos específicos procure nas páginas de detalhamento dos reparos.

DETALHAMENTO DE REPAROS

*₁ MANGUEIRA METÁLICA BAIXA PRESSÃO 2,0

CR - CPD.01848



Obs.: 2,00 m de comprimento

*₂ SUPORTE PISTOLA AJET

BR - CPD.04953

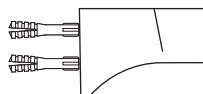

*₃ SALVA CHUVEIRO

CPD.00009

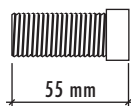

*₄ CRIVOS SAVAGE/PICCOLO

CPD.03961



alta pressão



parafuso Savage



baixa pressão



parafuso Piccolo

*₅ GUARNIÇÃO ½"

CPD.00179



Obs.: Kit com 12 unidades

*₆ CARTUCHO DESVIADOR DUCHA

CPD.01860

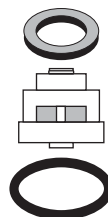

DETALHAMENTO DE REPAROS

*₇ BOTÃO DESVIADOR SAVAGE PUNHO

CR - CPD.01858



POSICIONADOR ARTICULÁVEL SAVAGE

CR/CR - CPD.00196

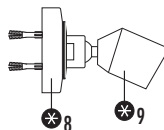
*₈ CANOPLA SELECTA

CR - CPD.01094

*₉ SUPORTE PLÁSTICO SAVAGE

CR/CR - CPD.05080

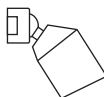



Ascot



Digital Line



Duello



Lyon



Oggi



Petra



Adagio



Caprice



Domani



Image



Orion



Squadra



Sirius



Trezzo



Vesper P

Fora de linha

As canoplas acompanham as linhas (vide cap. 1)

Corpo do registro (não é vendido separadamente)

* 1 e 2

* 8 e 9

MECANISMO CERÂMICO 1/2" FECHAMENTO HORÁRIO CPD.02102

PRENSA CANOPLA T1/T2 CPD.00185

As linhas Sirius e Vesper utilizam mangueira plástica (vide *4)

* 4 e 5

MANGUEIRA METÁLICA AJET CR/CR - CPD.01845

Obs.: 1,20 m de comprimento

PISTOLA AJET CR/CR - CPD.05974 BR/CR - CPD.07821

SUPORTE PISTOLA AJET BR - CPD.04953



Recursos especiais para casos específicos procure nas páginas de detalhamento dos reparos.

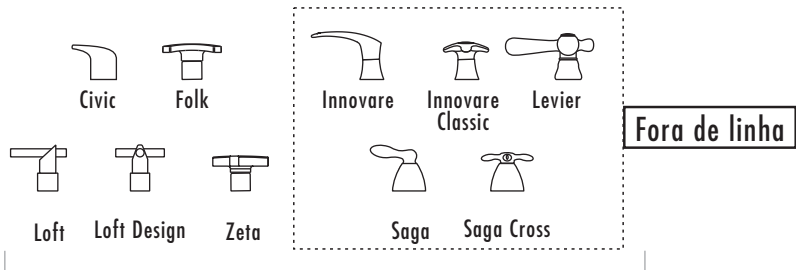

As canoplas acompanham as linhas (vide cap. 1)

Corpo do registro (não é vendido separadamente)

MECANISMO CERÂMICO 1/2" FECHAMENTO HORÁRIO CPD.02102

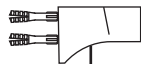
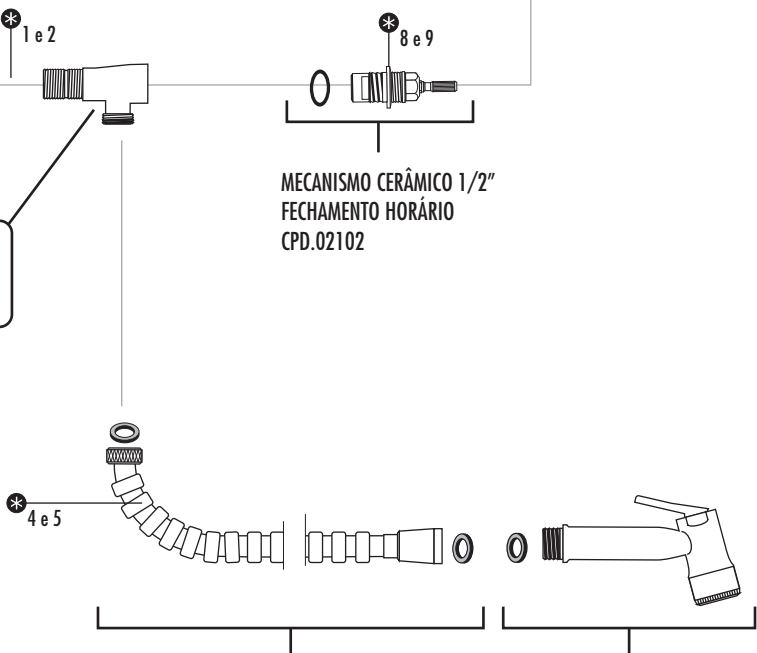

SUPORE PISTOLA AJET BR - CPD.04953

MANGUEIRA METÁLICA AJET CR/CR - CPD.01845

Obs.: 1,20 m de comprimento

PISTOLA AJET CR/CR - CPD.05974 BR/CR - CPD.07821



Recursos especiais para casos específicos procure nas páginas de detalhamento dos reparos.

ACABAMENTO TORNEIRA
SOHO
CR - CPD.04316

Aquarius

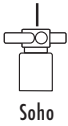

Soho



PRENSA CANOPLA
AQUARIUS
CR - CPD.01639



Jolie

Fora de linha

As canoplas
acompanham
as linhas
(vide cap. 1)

* 1 e 2

* 8 e 9

MECANISMO CERÂMICO 1/2"
FECHAMENTO HORÁRIO
CPD.02102

Corpo do registro
(não é vendido
separadamente)

* 4 e 5

MANGUEIRA METÁLICA AJET
CR/CR - CPD.01845

Obs.: 1,20 m de
comprimento

PISTOLA AJET
CR/CR - CPD.05974
BR/CR - CPD.07821

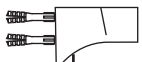

SUORTE PISTOLA AJET
BR - CPD.04953



Recursos especiais para casos específicos procure nas páginas de detalhamento dos reparos.

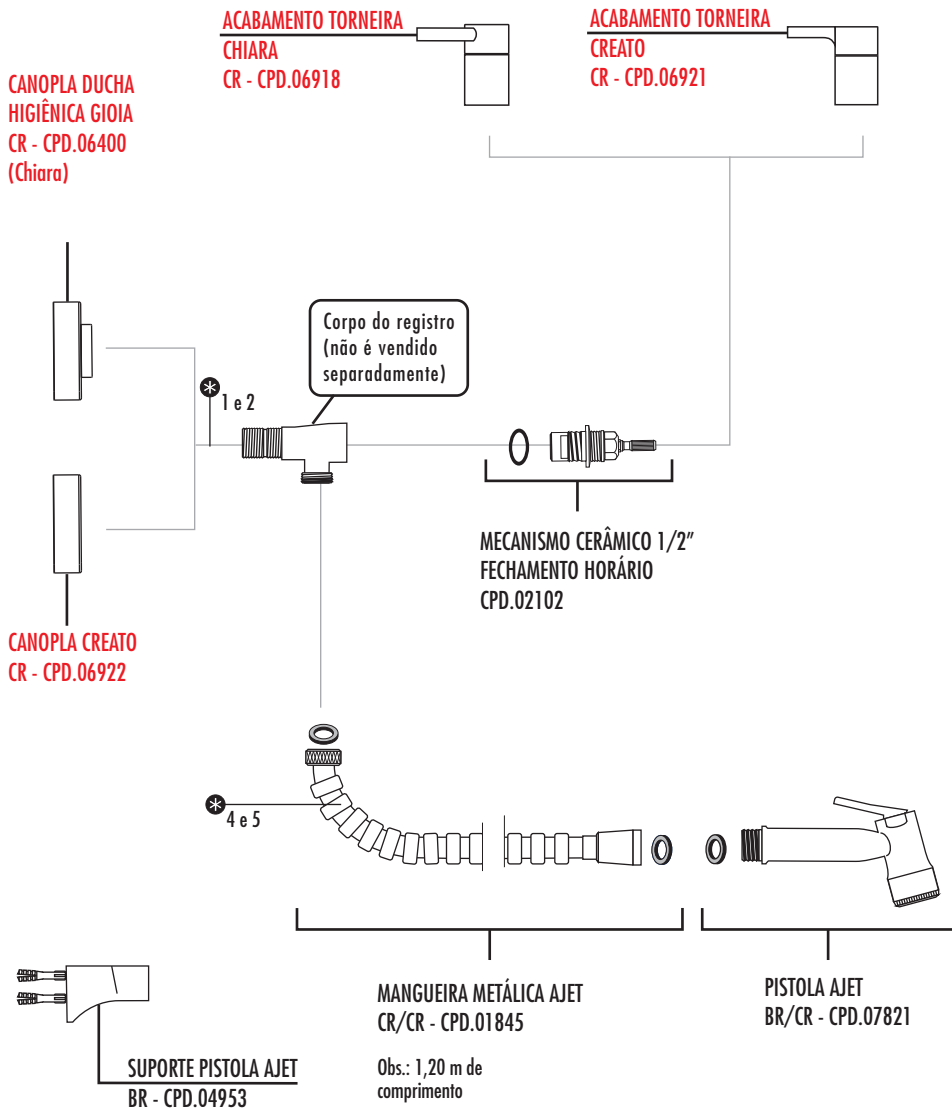

Recursos especiais para casos específicos procure nas páginas de detalhamento dos reparos.

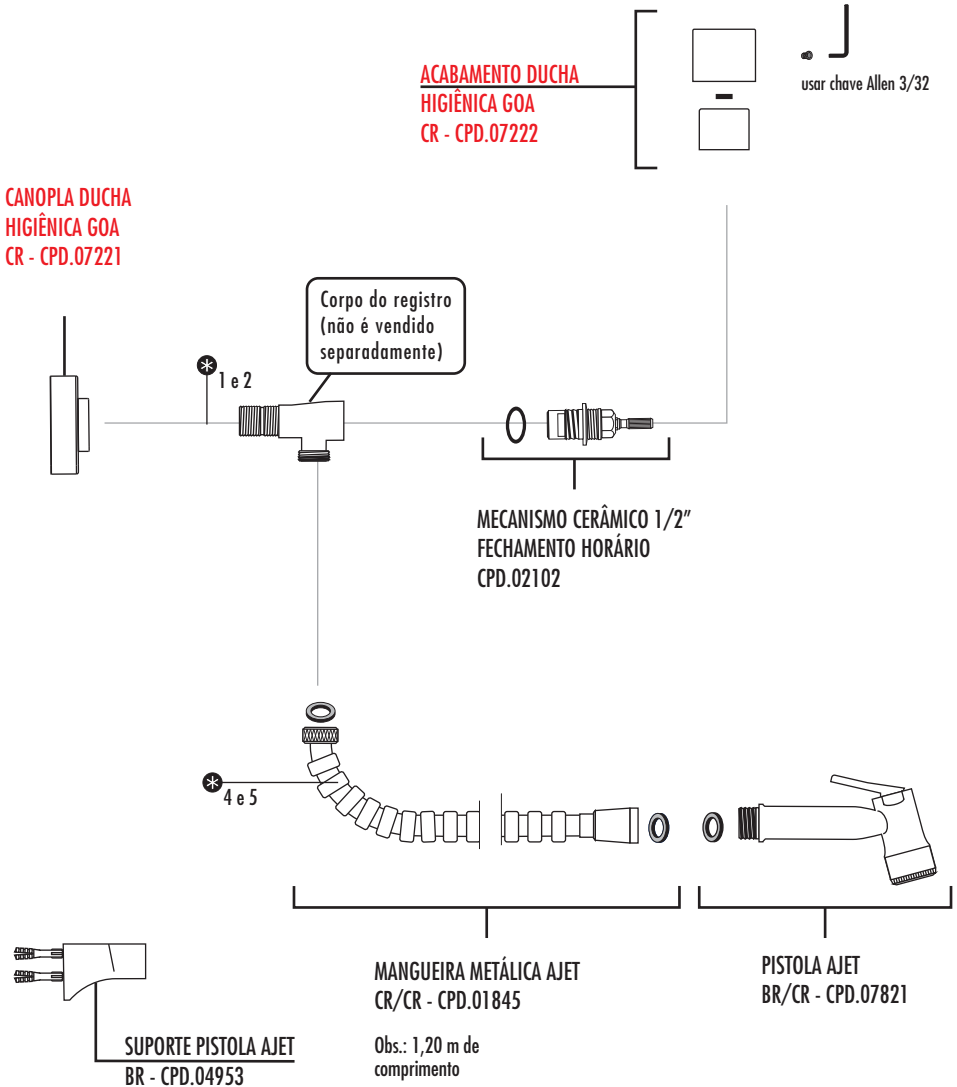

Recursos especiais para casos específicos procure nas páginas de detalhamento dos reparos.

Fora de linha



SUPORE SIMETRIA
CR - CPD.06200



Simetria

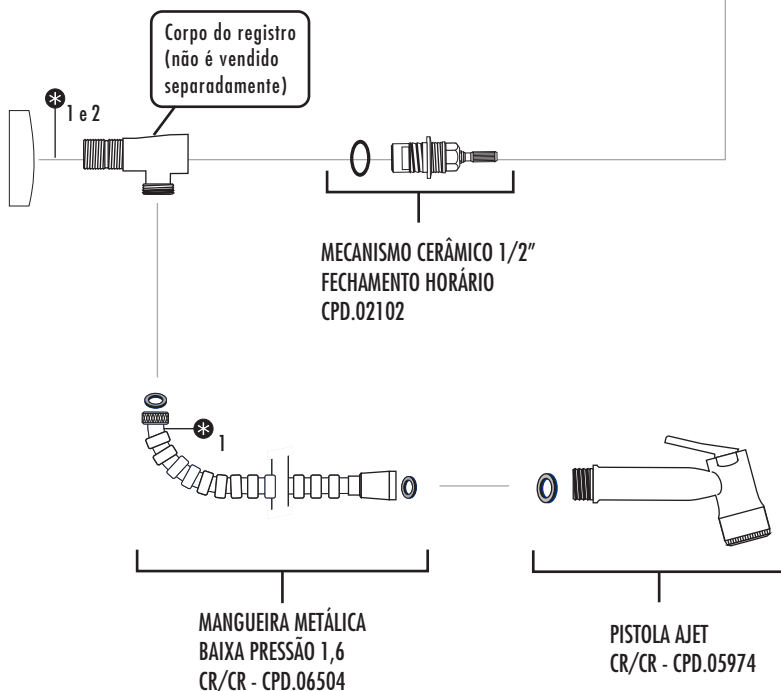

Recursos especiais para casos específicos procure nas páginas de detalhamento dos reparos.

Fora de linha

CANOPLA DUCHA
HIGIÊNICA GIOIA
CR - CPD.06400



Lucca

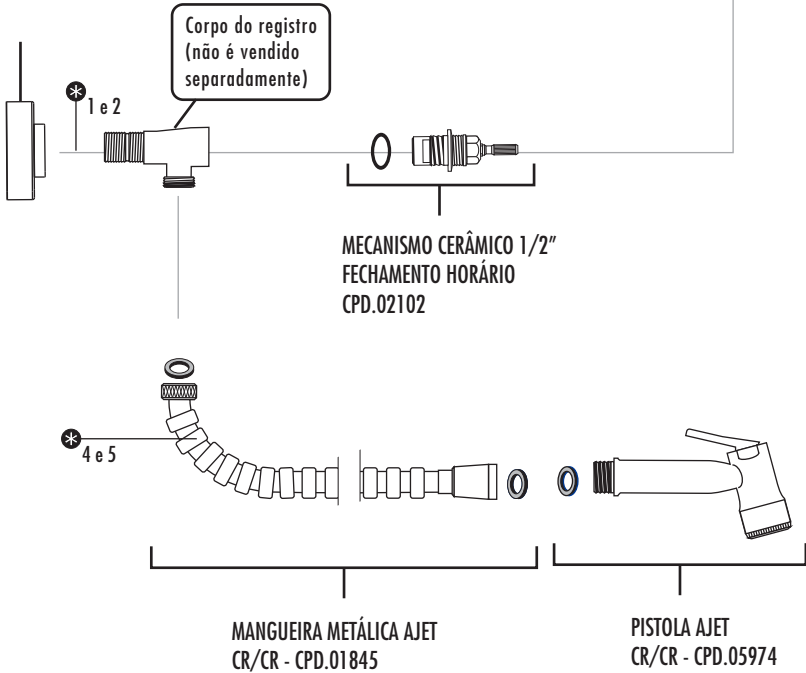

Obs.: 1,20 m de comprimento

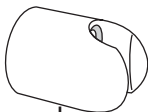

SUPORTE SIMETRIA
CR - CPD.06200



Recursos especiais para casos específicos procure nas páginas de detalhamento dos reparos.

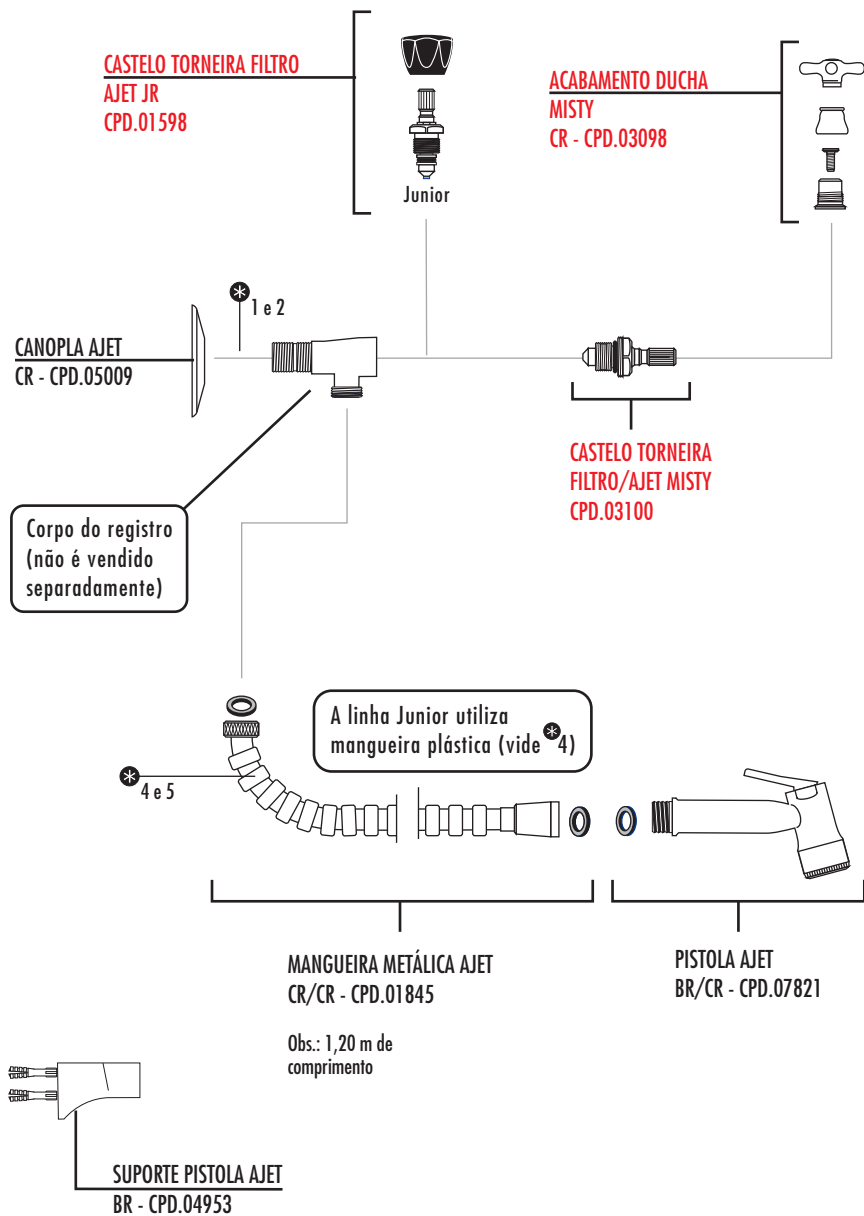

Recursos especiais para casos específicos procure nas páginas de detalhamento dos reparos.

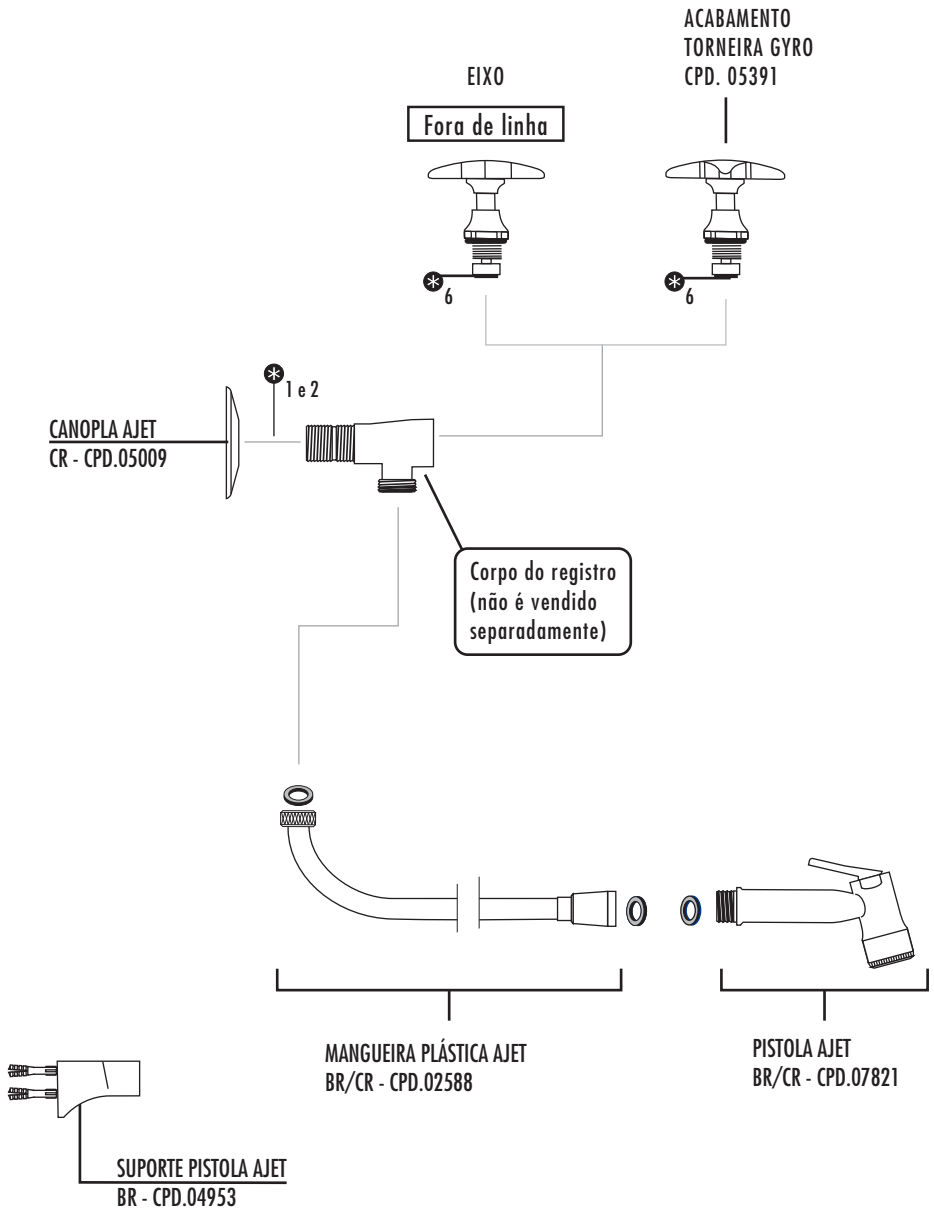

Recursos especiais para casos específicos procure nas páginas de detalhamento dos reparos.

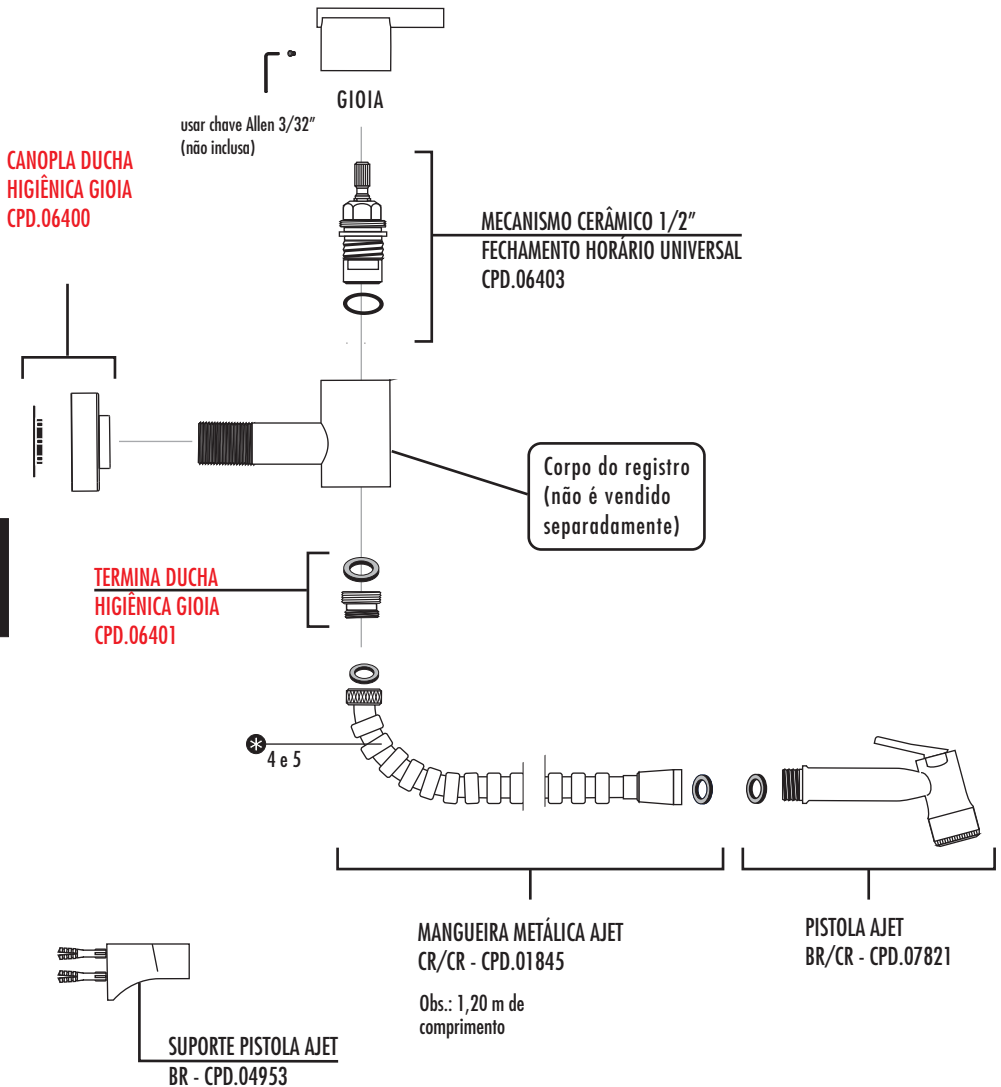

Recursos especiais para casos específicos procure nas páginas de detalhamento dos reparos.

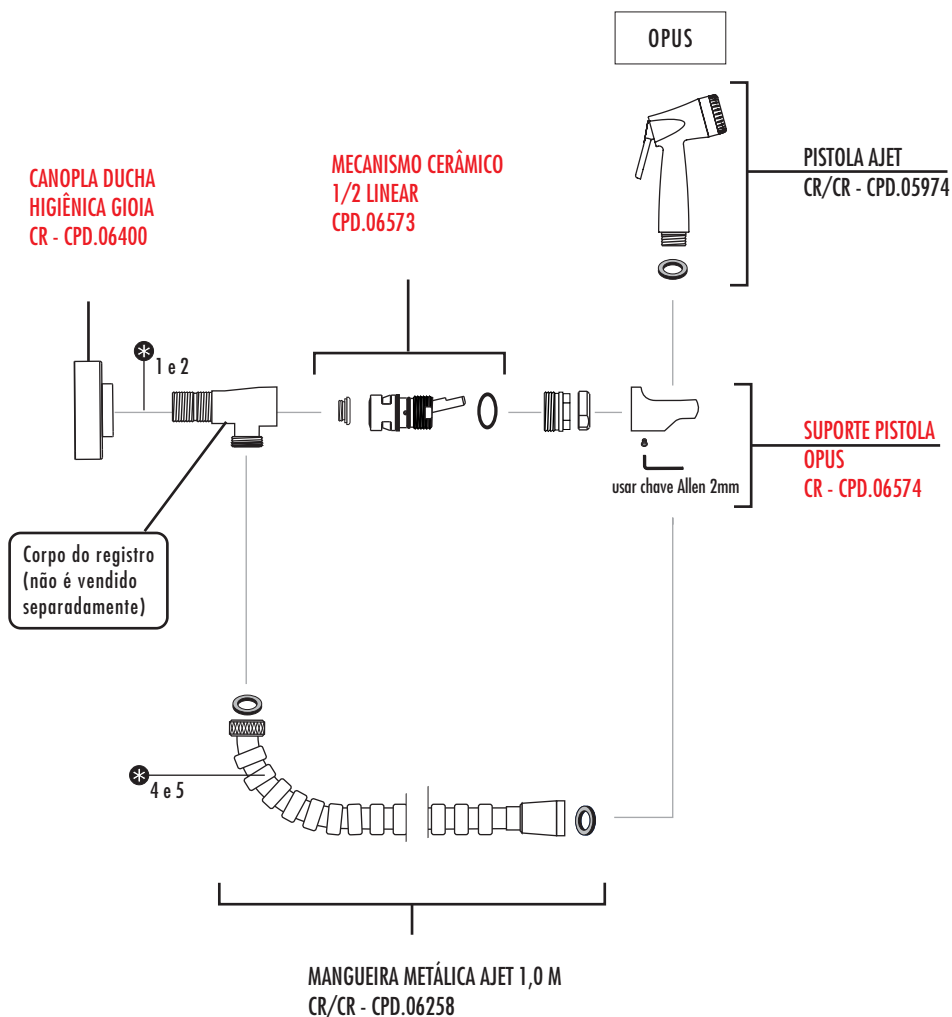

Recursos especiais para casos específicos procure nas páginas de detalhamento dos reparos.

Fora de linha
A partir de nov/2015,
estas linhas passaram
a utilizar o mecanismo
cerâmico 1/4 de volta.



Ascot



Digital
Line



Duello



Lyon



Oggi

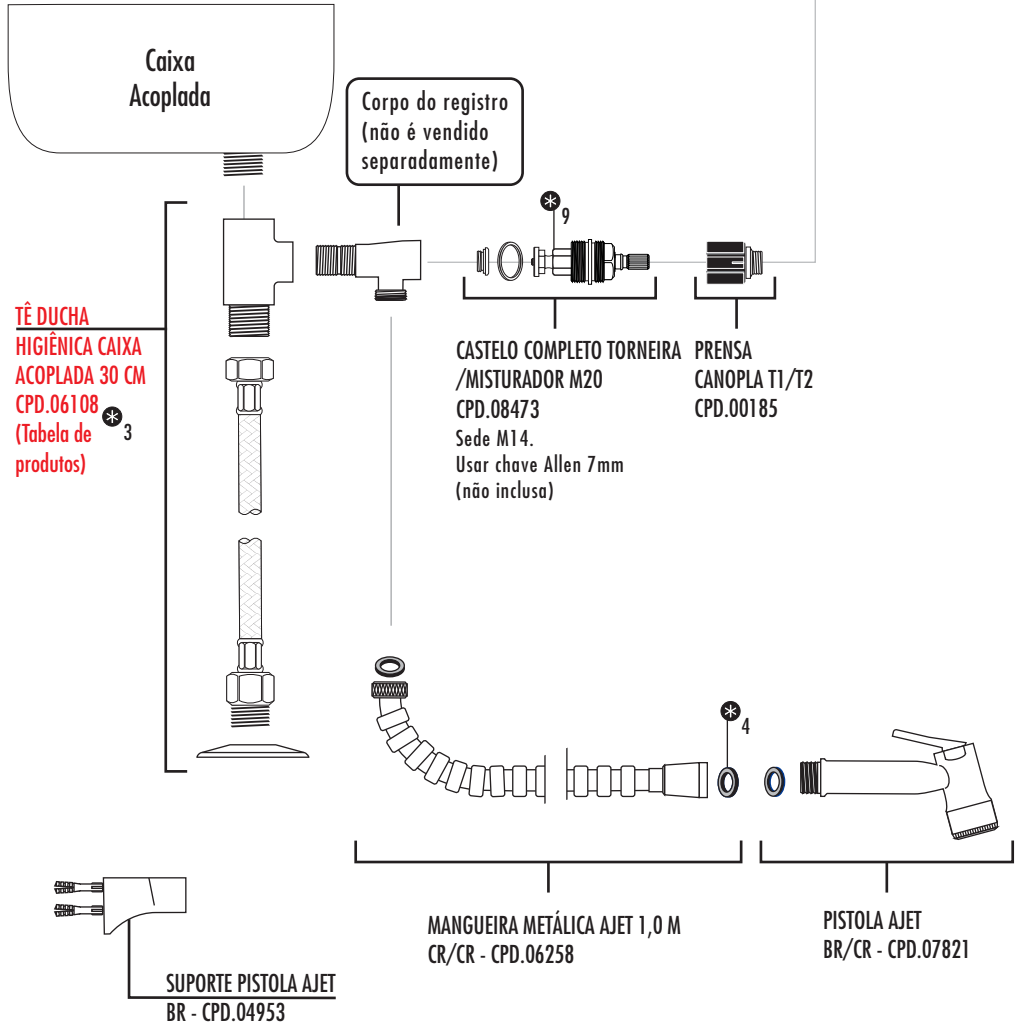

Recursos especiais para casos específicos procure nas páginas de detalhamento dos reparos.

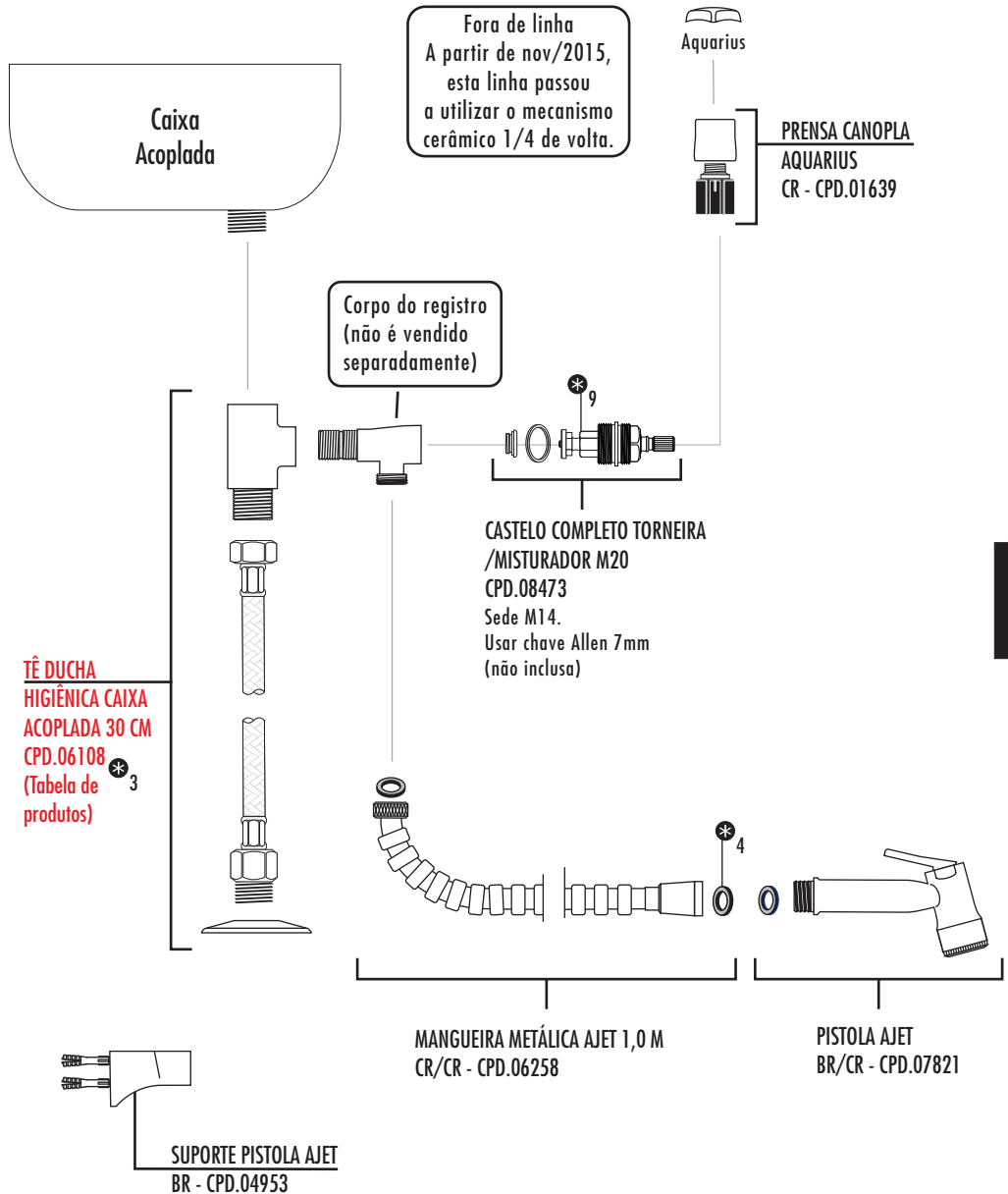

Recursos especiais para casos específicos procure nas páginas de detalhamento dos reparos.

Fora de linha

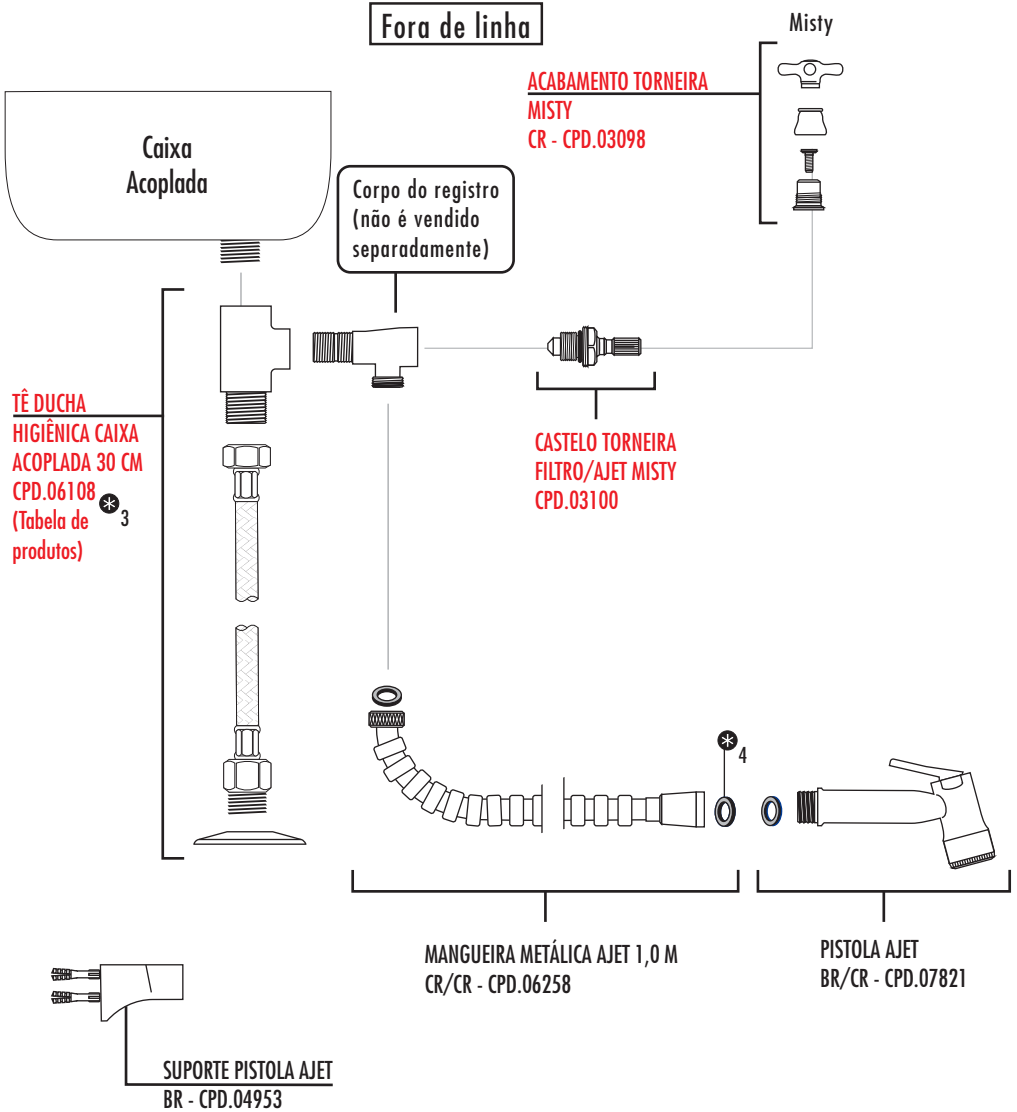

Recursos especiais para casos específicos procure nas páginas de detalhamento dos reparos.



Chiara



Aquarius



Ascot



Digital
Line



Petra



Creato



Domani



Duello



Folk



Lucca



Lyon



Oggi



Soho



Zeta

Fora de linha

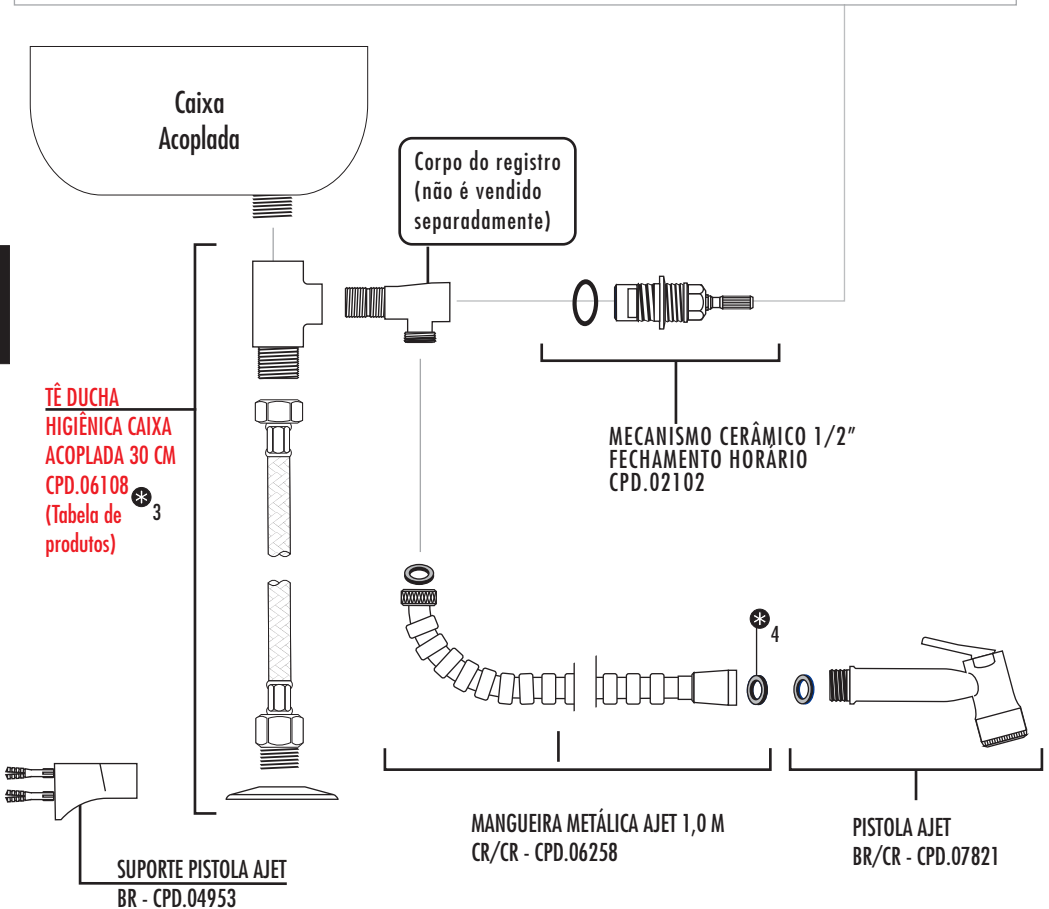

Recursos especiais para casos específicos procure nas páginas de detalhamento dos reparos.

Fora de linha

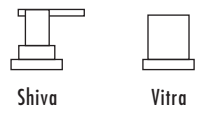

Shiva

Vitra

sede M22
usar chave Allen 14mm
(não inclusa)

SAÍDA PAREDE SHIVA
CR - 06419

MECANISMO CERÂMICO 3/4"
FECHAMENTO HORÁRIO AJUSTÁVEL
CPD.06117

*
4 e 5

MANGUEIRA METÁLICA AJET
CR/CR - CPD.01845
Obs.: 1,20 m de
comprimento

PISTOLA AJET
CR/CR - CPD.05974

SUPORTE QUADRADO
CR - CPD.05975



Recursos especiais para casos específicos procure nas páginas de detalhamento dos reparos.

Fora de linha

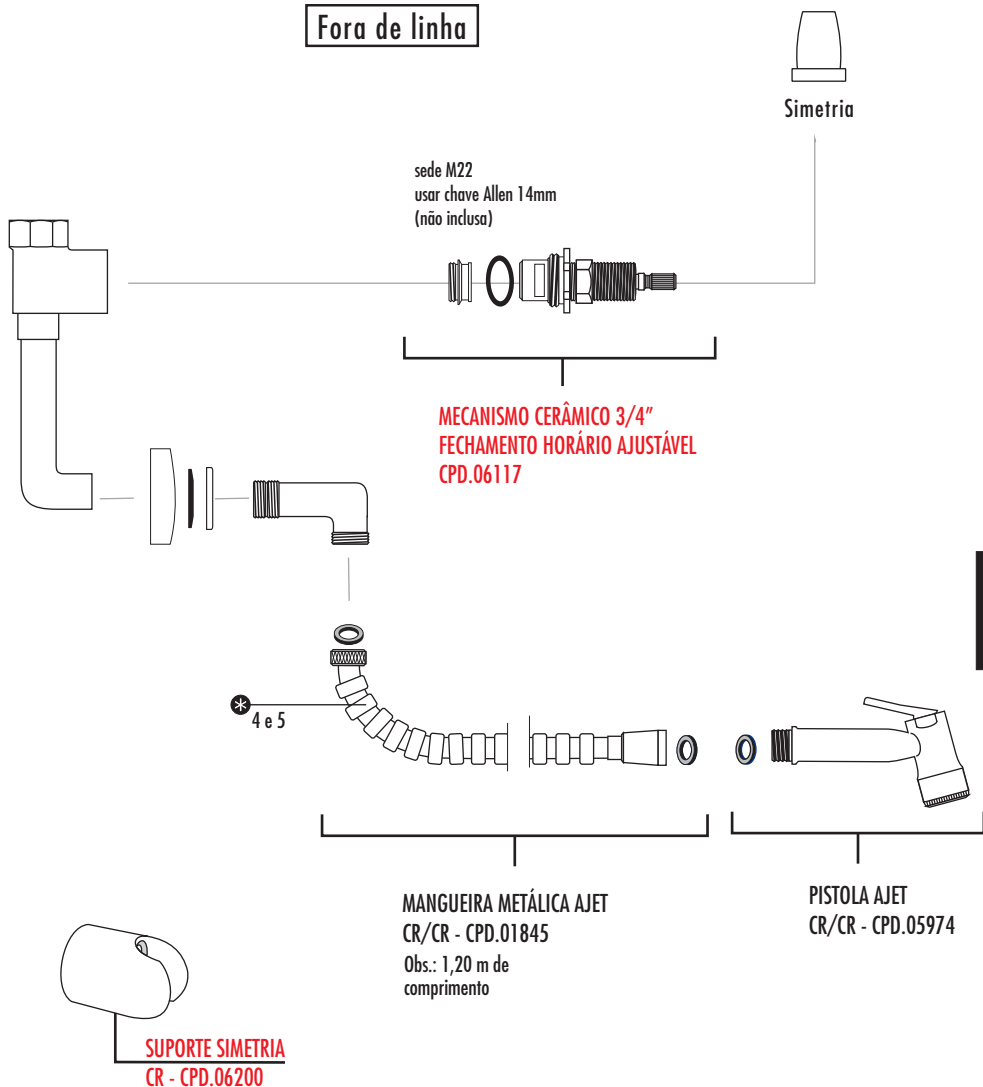

Recursos especiais para casos específicos procure nas páginas de detalhamento dos reparos.

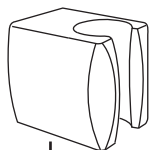
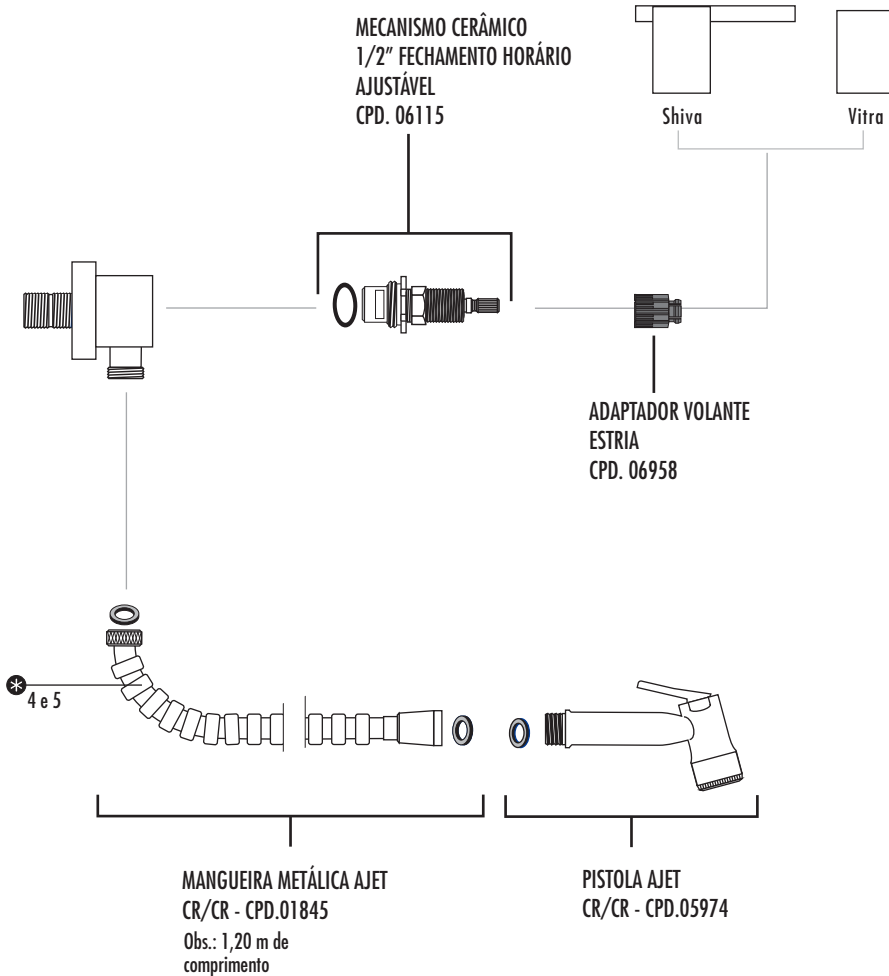

SUPORTE QUADRADO
CR - CPD.05975



Recursos especiais para casos específicos procure nas páginas de detalhamento dos reparos.

DETALHAMENTO DE REPAROS

* 1 TÊ ADAPTADOR AJET

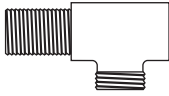

CR - CPD.00168

O Tê adaptador AJet permite a instalação da ducha AJet aproveitando a saída de água para caixas acopladas.

* 2 TÊ AJET PISO

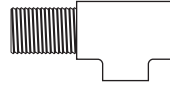

CR - CPD.01715

* 3 TÊ DUCHA HIGIÊNICA CAIXA ACOPLADA 40 CM

CPD. 06109



(Tabela de produtos)

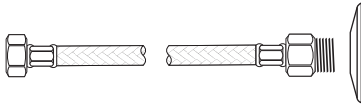

* 4 MANGUEIRA PLÁSTICA AJET

BR/CR - CPD.02588

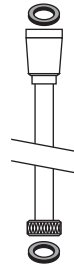

Obs.: 1,20 m de comprimento

* 5 GUARNIÇÃO 1/2"

CPD.00179



Obs.: Kit com 12 unidades

* 6 CARRAPETA GYRO

CPD. 05393



* 8 CASTELO COMPLETO TORNEIRA / MISTURADOR M20

CPD.08473

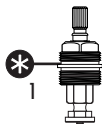

Rosca M12
Sext. 7mm

Rosca M14
Sext. 7mm

* 9 VEDAÇÃO CASTELOS 1/2", 3/4"

CPD.01109

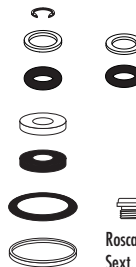

Rosca M12
Sext. 7mm

Rosca M14
Sext. 7mm

Rosca M14
Sext. 3/8"

Fora de linha

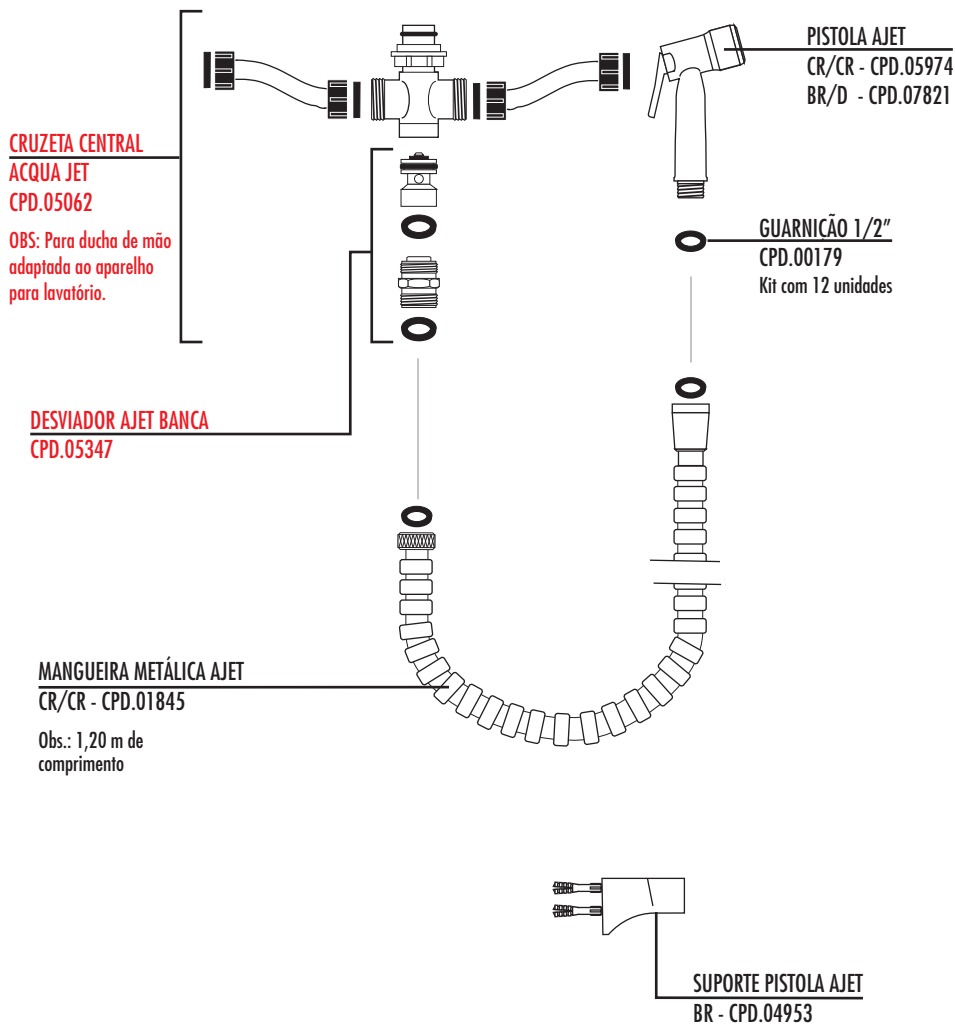

Fora de linha

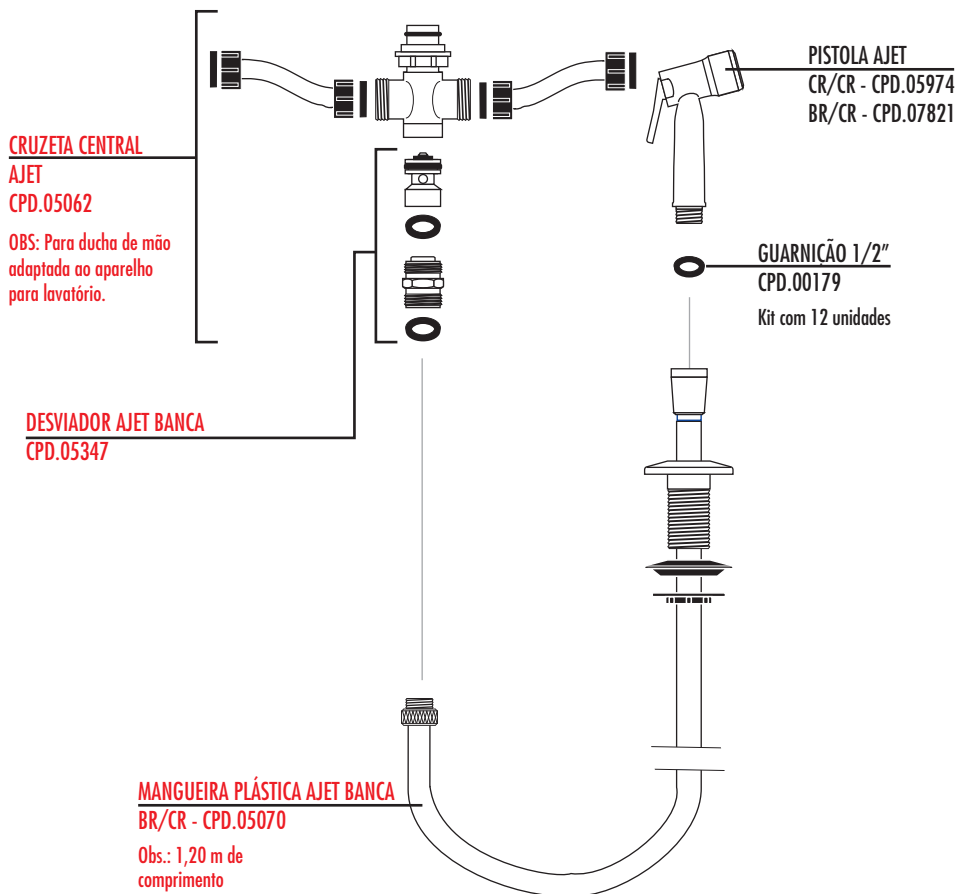

VDE

Página 7.01

DETALHAMENTO DE REPAROS

Página 7.02

FLUX

Página 7.03

DETALHAMENTO DE REPAROS

Página 7.04

SILENT FLUX

Página 7.05

DETALHAMENTO DE REPAROS

Página 7.06

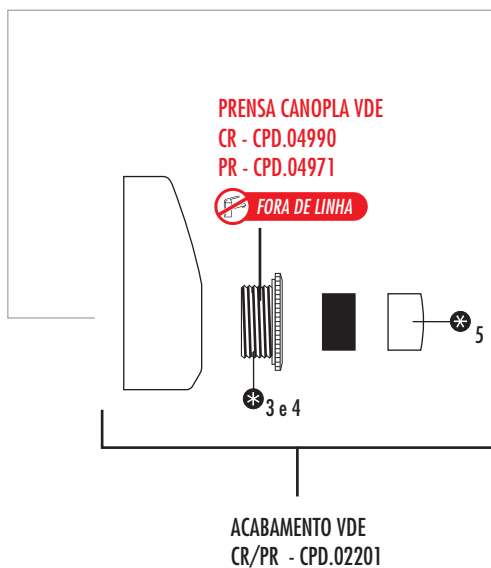
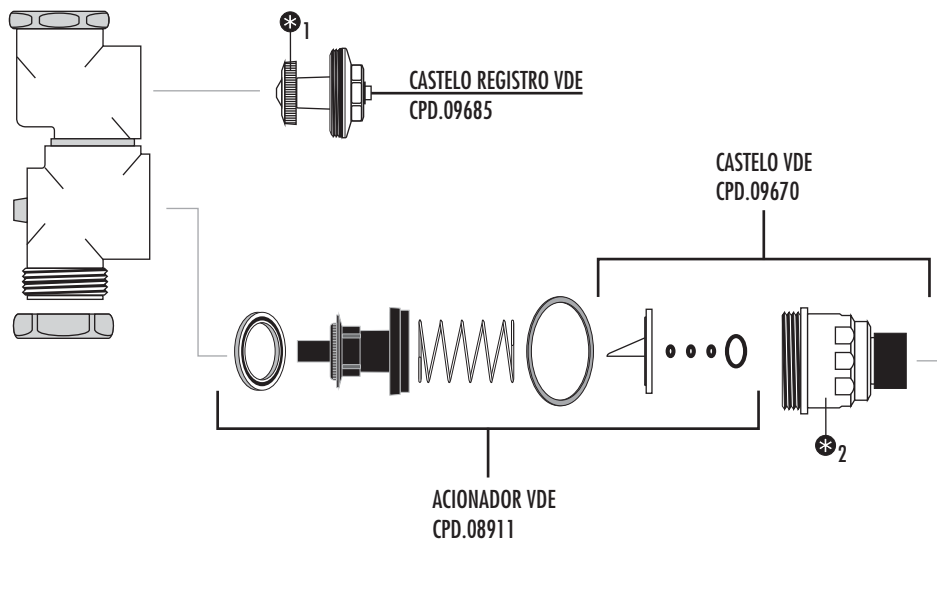

Os reparos servem tanto para bitolas de 1 1/2" como de 1 1/4".



Recursos especiais para casos específicos procure nas páginas de detalhamento dos reparos.

DETALHAMENTO DE REPAROS

* 1 REGISTRO VDE/SFLUX

CPD.09678



* 2 MECANISMO CASTELO VDE

CPD.00201

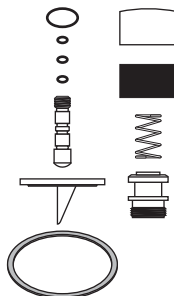

* 3 RECURSO VDE ENTERRADA

CR - CPD.09707

FORA DE LINHA

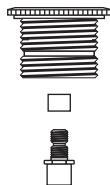

Obs: Solução para válvula enterrada em até 25mm.

* 4 RECURSO VDE SALIENTE

CR - CPD.09714

FORA DE LINHA



Obs: Solução para válvula saliente em até 10mm.

* 5 BOTÃO ACIONADOR VDE

CR - CPD.03836

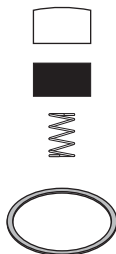

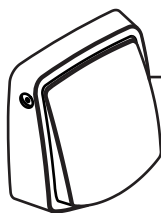
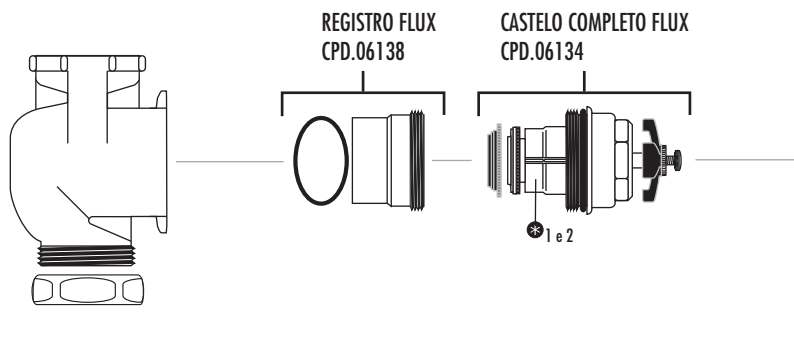

ACABAMENTO VÁLVULA FLUX AV
CR - CPD.06259 (Tabela de produtos)

OBS: Este acabamento se adapta às bases dos concorrentes.
Parafusos de fixação inclusos.

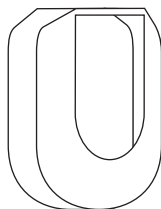

BOTÃO ACIONADOR FLUX
CR - CPD.06131
PR - CPD.06133

ACABAMENTO FLUX (Tabela de produtos)

CR/CR - CPD.06609	BR/BR - CPD.02268	CR/D - CPD.06610
BE/BE - CPD.02269	BR/CR - CPD.06606	CR/PR - CPD.06611
	BR/PR - CPD.06608	



Recursos especiais para casos específicos procure nas páginas de detalhamento dos reparos.

DETALHAMENTO DE REPAROS

*₁ PISTÃO FLUX

CPD.06136

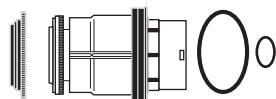

*₂ HASTE FLUX

CPD.01583



*₃ RECURSO FLUX ENTERRADA

CPD.06760

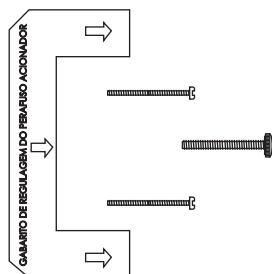

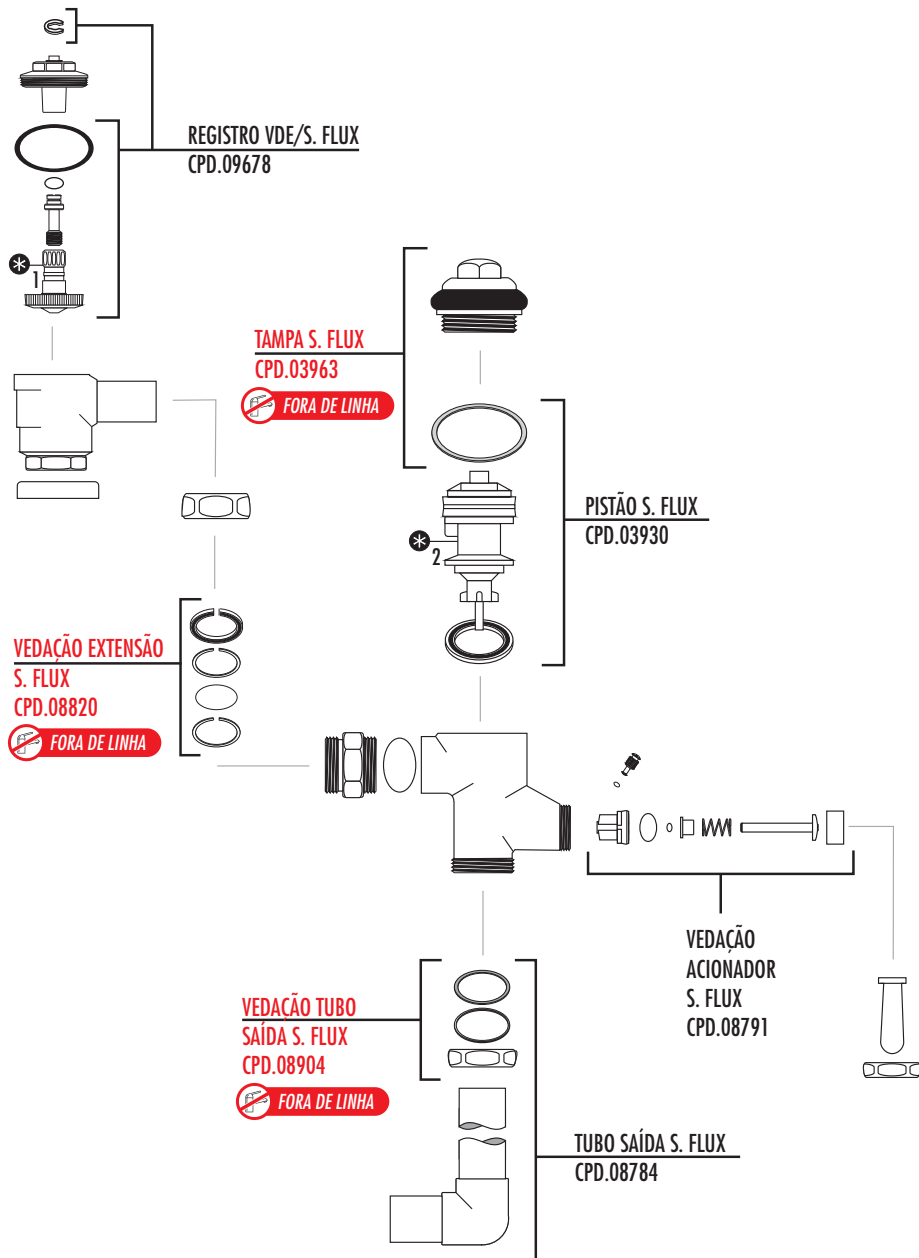

Recursos especiais para casos específicos procure nas páginas de detalhamento dos reparos.

DETALHAMENTO DE REPAROS

*₁ VEDAÇÃO REGISTRO S. FLUX ANTIGA

CPD.08813

*₂ VEDAÇÃO PISTÃO S. FLUX

CPD.08806

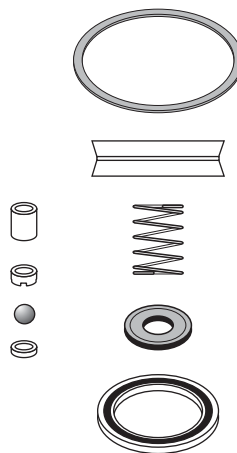

TORNEIRA / MICTÓRIO ACQUAMAGIC

Página 8.01

TORNEIRA / MICTÓRIO VISION

Página 8.03

TORNEIRA DE PAREDE / MICTÓRIO EMBITIDA VISION

Página 8.07

VÁLVULA DE DESCARGA FLUX WAVE

Página 8.08

DETALHAMENTO DE REPAROS

Páginas 8.09 e 8.10

ALIMENTAÇÃO ELÉTRICA

Fora de linha

AREJADOR T2 MACHO
CPD.07101

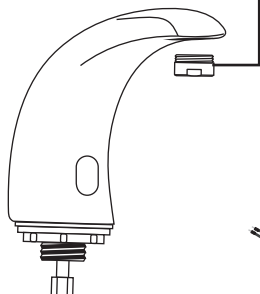

Adaptador
para
bico antigo



FOTOCÉLULA TORNEIRA
ELÉTRICA BANCA
CPD.01618

Obs: Sensibilidade
até 20 cm

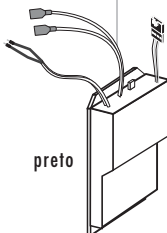

CIRCUITO ELÉTRICO
110/220v
CPD.01186

TUBO FLEXÍVEL
TORNEIRA BANCA
CPD.01620

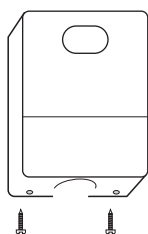
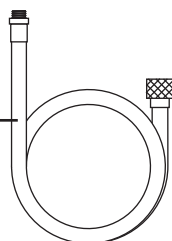

CAIXA PLÁSTICA
BR - CPD.01167

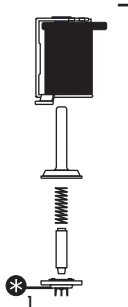

ACIONADOR
VÁLVULA
SOLENÓIDE
ELÉTRICA
ACQUAMAGIC
CPD.01364

VÁLVULA
SOLENÓIDE
ELÉTRICA
ACQUAMAGIC
CPD.01911

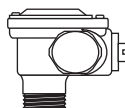

Recursos especiais para casos específicos procure nas páginas de detalhamento dos reparos.

ALIMENTAÇÃO ELÉTRICA

Fora de linha

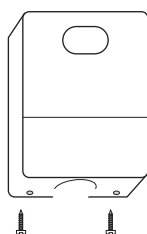

CAIXA PLÁSTICA
BR - CPD.01167



FOTOCÉLULA TORNEIRA
ELÉTRICA PAREDE/MICTÓRIO
CPD.01619

Obs: Sensibilidade até 60 cm

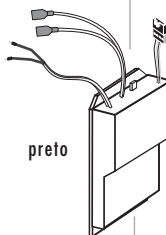

preto

CIRCUITO ELÉTRICO

110/220v
CPD.01186

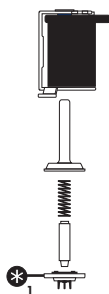

ACIONADOR
VÁLVULA
SOLENOÍDE
ELÉTRICA
ACQUAMAGIC
CPD.01364

VÁLVULA
SOLENOÍDE
ELÉTRICA
ACQUAMAGIC
CPD.01911

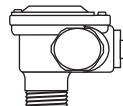

TORNEIRA DE PAREDE
Ref: 1193

AREJADOR T2 FÊMEA
CR - CPD.07116

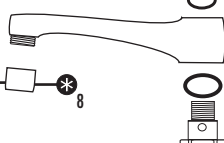

VÁLVULA DE DESCARGA
PARA MICTÓRIO
Ref: 3550

VEDAÇÃO
TORNEIRA
TOP-JET
CPD.01139



Recursos especiais para casos específicos procure nas páginas de detalhamento dos reparos.

STANDARD - ALIMENTAÇÃO ELÉTRICA

AREJADOR CURTO T2 MACHO
CPD.07225

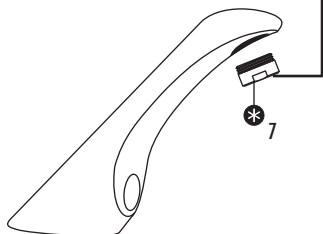

* 7

BICO TORNEIRA VISION
CR - CPD.04124



FLEXÍVEL MONOCOMANDO
40 CM
CPD.03151



FIXAÇÃO MONOCOMANDO
CPD.04017

VÁLVULA SOLENÓIDE ELÉTRICA CORPO PLÁSTICO 12 VOLTS
CPD.07198

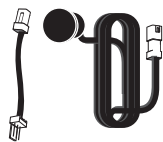

(adaptador fonte 12 volts antiga)

FOTOCIRCUITO TORNEIRA BANCA ELÉTRICA
CPD.07081 * 3

I M P O R T A N T E :
1 - Este Fotocircuito substitui o Circuito + Fotocélula do modelo antigo.
2 - É possível trocar somente a fotocélula - CPD 04137, que ainda está em linha (página 8.13).

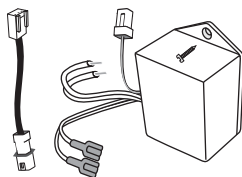

(adaptador circuito antigo)

FORNE ENCAPSULADA 12 VOLTS
CPD.07192

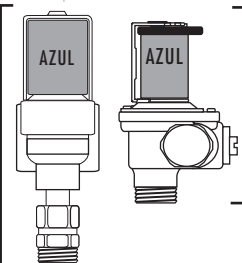

1195-EL

1195-EL-REG

VÁLVULA SOLENÓIDE ELÉTRICA 12 VOLTS
CPD.07195

* 1 e 2

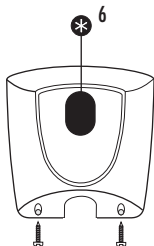

* 6

CAIXA PLÁSTICA VISION BANCA
CPD.07138

Recursos especiais para casos específicos procure nas páginas de detalhamento dos reparos.

STANDARD - ALIMENTAÇÃO ELÉTRICA

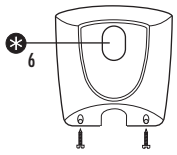

CAIXA PLÁSTICA VISION
CPD.04126

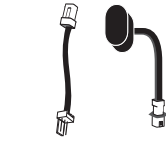

(adaptador fonte
12 volts antiga)

FOTOCIRCUITO * 4
CPD.07082 - TORNEIRA PAREDE
CPD.07083 - MICTÓRIO

I M P O R T A N T E :
1 - Este Fotocircuito substitui o Circuito + Fotocélula do modelo antigo.
2 - É possível trocar somente a fotocélula - CPD 04135, que ainda está em linha (página 8.13).

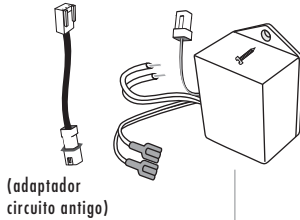

(adaptador
circuito antigo)

Fonte Encapsulada
12 Volts
CPD.07192

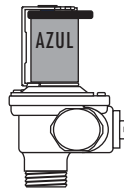

VÁLVULA SOLENÓIDE
ELÉTRICA 12 VOLTS
CPD.07195

1195-EL-REG

* 1 e 2

ECONOMIZADOR 8L
CPD.06327

GUARNIÇÃO 1/2"
CPD.00179

TORNEIRA DE PAREDE
Ref: 1193

VÁLVULA DE DESCARGA
PARA MICTÓRIO
Ref: 3550

AREJADOR T2 FÊMEA
CR - CPD.07116

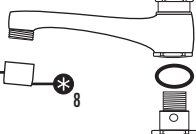

VEDAÇÃO
TORNEIRA
TOP-JET
CPD.01139



Recursos especiais para casos específicos procure nas páginas de detalhamento dos reparos.

ANTI-VANDALISMO - ALIMENTAÇÃO ELÉTRICA

**AREJADOR T2 MACHO AV
CR - CPD.01429**

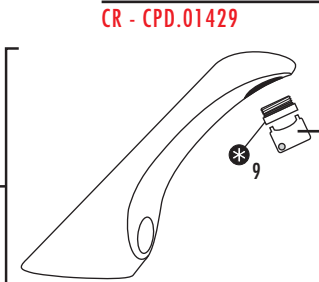

**BICO TORNEIRA
VISION
CR - CPD.04124**

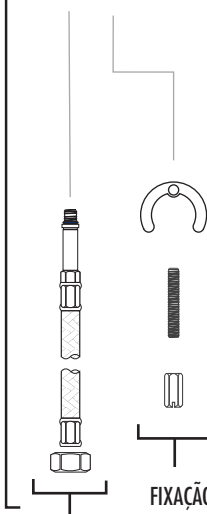

**FLEXÍVEL
MONOCOMANDO
40 CM
CPD.03151**

**FIXAÇÃO
MONOCOMANDO
CPD.04017**



(adaptador fonte
12 volts antiga)

**FOTOCIRCUITO TORNEIRA
BANCA ELÉTRICA
CPD.07081 * 3**

I M P O R T A N T E :
1 - Este Fococircuito substitui o
Circuito + Fococélula do modelo antigo.
2 - É possível trocar somente a
fococélula - CPD 04137, que ainda
está em linha (página 8.13).

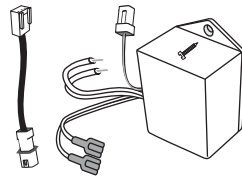

(adaptador
circuito antigo)

**FORTE ENCAPSULADA
12 VOLTS
CPD.07192**

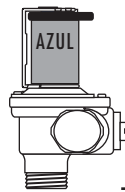

**VÁLVULA SOLENÓIDE
ELÉTRICA 12 VOLTS
CPD.07195**

1195-EL-AV-REG

* 1 e 2

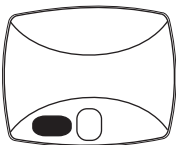

**CAIXA ANTI-VANDALISMO VISION
CPD.04146**

Recursos especiais para casos específicos procure nas páginas de detalhamento dos reparos.

ANTI-VANDALISMO - ALIMENTAÇÃO ELÉTRICA

CAIXA AV
PAREDE VISION
CPD.04145

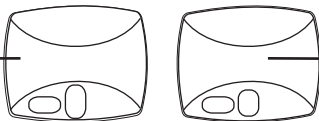

CAIXA AV
VISION
CPD.04146
(MICTÓRIO)

(adaptador fonte
12 volts antiga)

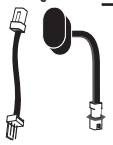

FOTOCIRCUITO

* 5

CPD.07082 - TORNEIRA PAREDE
CPD.07083 - MICTÓRIO

I M P O R T A N T E :
1 - Este Fococircuito substitui o Circuito + Fococélula do modelo antigo.
2 - É possível trocar somente a fotocélula - CPD 04133, que ainda está em linha (página 8.13).

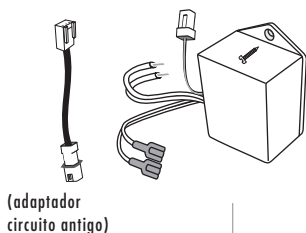

(adaptador
circuito antigo)

FORTE ENCAPSULADA
12 VOLTS
CPD.07192

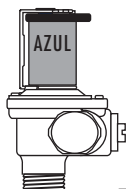

VÁLVULA SOLENÓIDE
ELÉTRICA 12 VOLTS
CPD.07195

* 1 e 2

1195-EL-AV-REG

ECONOMIZADOR 8L
CPD.06327

GUARNIÇÃO 1/2"
CPD.00179

VÁLVULA DE DESEARGA
PARA MICTÓRIO
Ref: 3550

TORNEIRA DE PAREDE
Ref: 1193

AREJADOR T2 FÊMEA
CR - CPD.07116

* 8

VEDAÇÃO
TORNEIRA
TOP-JET
CPD.01139



Recursos especiais para casos específicos procure nas páginas de detalhamento dos reparos.

ANTI-VANDALISMO - EMBUTIDA

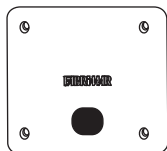

FOTOCÉLULA AV ELÉTRICA
VISION
CPD.04133

Obs: Sensibilidade até 60 cm



CIRCUITO 110/220V
ELÉTRICO VISION
CPD.05580 (TORNEIRA)
CPD. 05582 (MICTÓRIO)

(adaptador
circuito antigo)

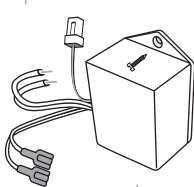

FONTE ENCAPSULADA
12 VOLTS
CPD.07192

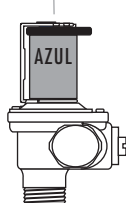
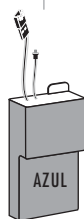

VÁLVULA SOLENÓIDE
ELÉTRICA 12 VOLTS
CPD.07195

1195-EL-REG

* 1 e 2

ECONOMIZADOR 8L
CPD.06327

GUARNIÇÃO 1/2"
CPD.00179

TORNEIRA DE PAREDE
Ref: 1200

AREJADOR
EMBUTIDO M18,5
CPD.05333



VÁLVULA DE DESCARGA
PARA MICTÓRIO
Ref: 3530



Recursos especiais para casos específicos procure nas páginas de detalhamento dos reparos.

Fora de linha

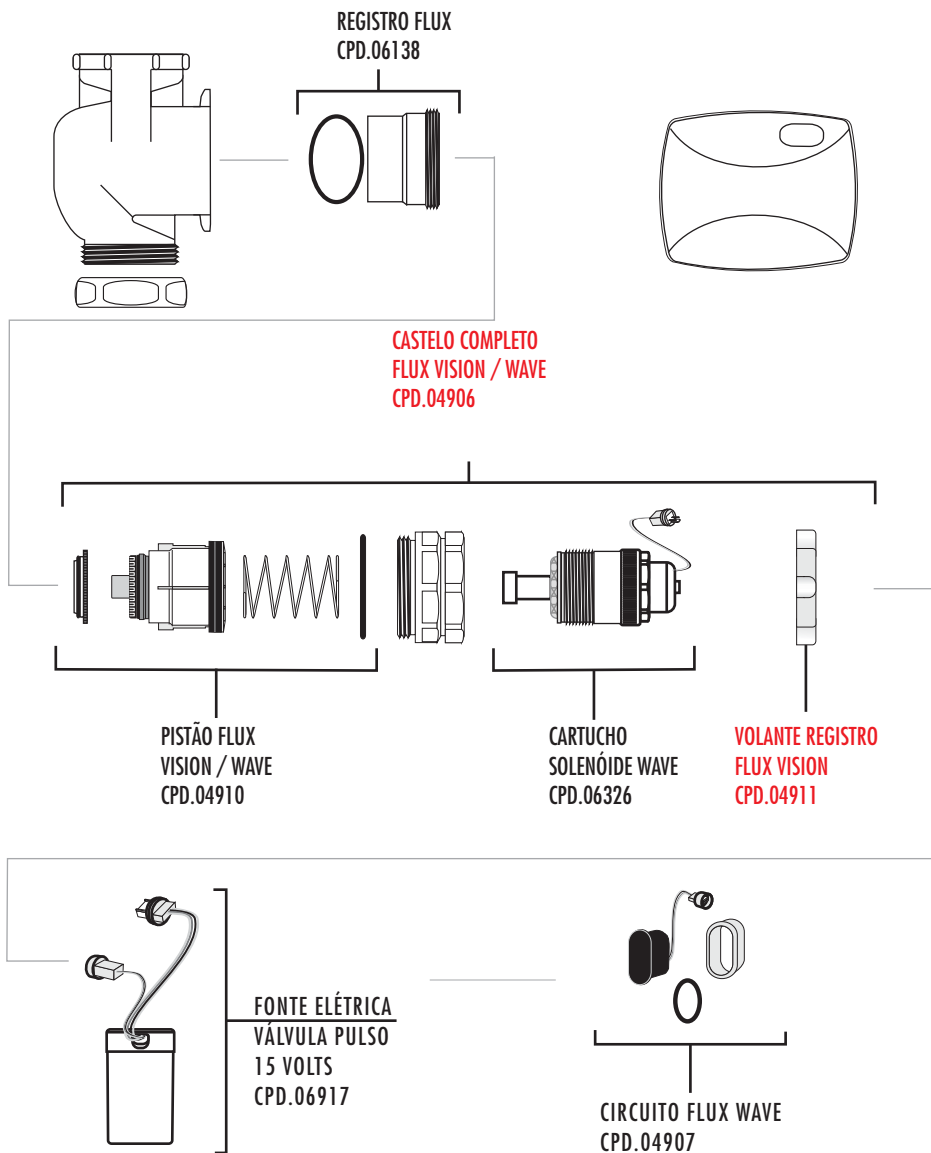

Recursos especiais para casos específicos procure nas páginas de detalhamento dos reparos.

DETALHAMENTO DE REPAROS

- * 1 ACIONADOR VÁLVULA SOLENÓIDE ELÉTRICA 12 VOLTS

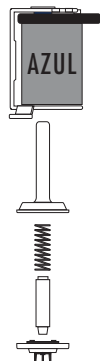

CPD.07193

- * 2 MEMBRANA VÁLVULA SOLENÓIDE ELÉTRICA



CPD.06213

- * 3 FOTOCÉLULA BANCA ELÉTRICA VISION

CPD.04137

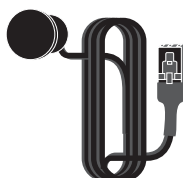

Obs: Sensibilidade até 20 cm

- * 4 FOTOCÉLULA PAREDE ELÉTRICA VISION

CPD.04135

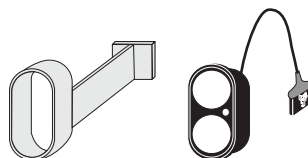

Obs: Sensibilidade até 60 cm

- * 5 FOTOCÉLULA AV ELÉTRICA VISION

CPD.04133



Obs: Sensibilidade até 60 cm

- * 6 LENTE CAIXA PLÁSTICA VISION

CPD.04140



DETALHAMENTO DE REPAROS

*7 AREJADOR T2 MACHO SPRAY

CR - CPD.06313

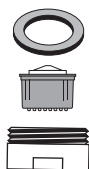

*8 AREJADOR T2 FÊMEA SPRAY

CR - CPD.06312



*9 AREJADOR T2 MACHO AV SPRAY

CR - CPD.06324



*10 AREJADOR EMBUTIDO SPRAY M18,5

CPD.06321

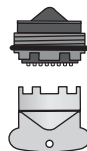

TORNEIRA BANCA ACQUAPRESS

Página 9.01

TORNEIRA PAREDE/MICTÓRIO ACQUAPRESS

Página 9.02

TORNEIRA BANCA/PAREDE BIOPRESS

Página 9.03

MICTÓRIO BIOPRESS

Página 9.04

TORNEIRA PAREDE/MICTÓRIO BIOPRESS AV

Página 9.05

CHUVEIRO BIOPRESS AV

Página 9.06

DETALHAMENTO DE REPAROS

Página 9.07

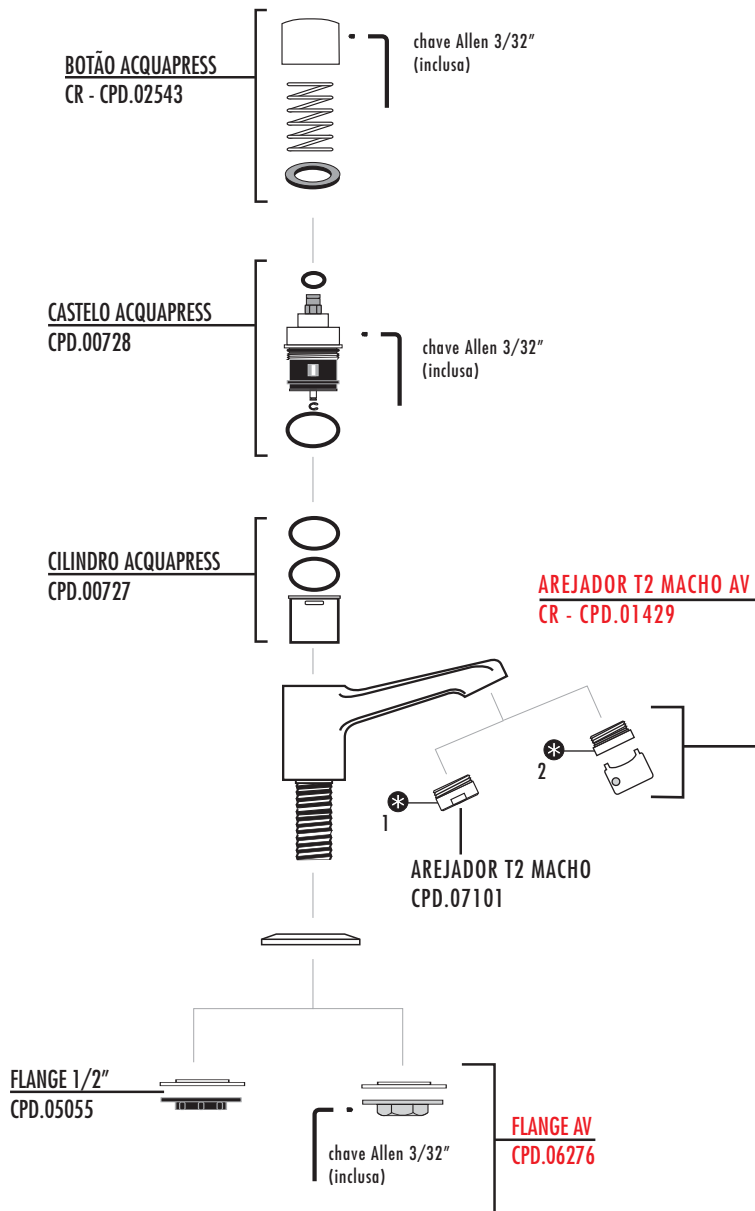

Recursos especiais para casos específicos procure nas páginas de detalhamento dos reparos.

BOTÃO ACQUAPRESS
CR - CPD.02543

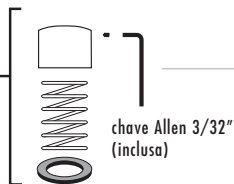

CASTELO ACQUAPRESS
CPD.00728

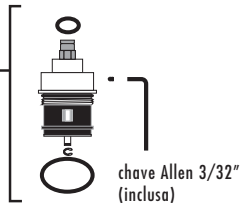

TORNEIRA DE PAREDE
Ref. 1182

CILINDRO ACQUAPRESS
CPD.00727



CANOPLA TORNEIRA
ACQUAPRESS PAREDE
CR - CPD.03099

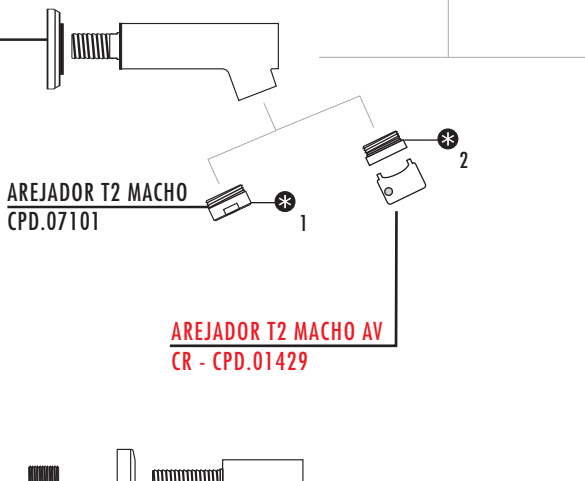

AREJADOR T2 MACHO
CPD.07101

AREJADOR T2 MACHO AV
CR - CPD.01429

VÁLVULA DE DESCARGA
PARA MICTÓRIO

Ref. 1181

BUCHA REDUÇÃO
3/4" X 1/2"

CR - CPD.04977
(Não acompanha o produto)

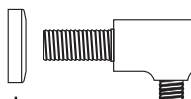

GUARNIÇÃO 1/2"
CPD.00179

CANOPLA SELECTA
CR - CPD.01094

Obs.: reparo padrão,
para uso com mictório
Acquapress não use a
peça de borracha.

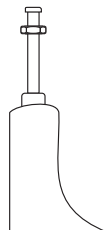

Recursos especiais para casos específicos procure nas páginas de detalhamento dos reparos.

TORNEIRA DE BANCA

Ref. 1180

* MECANISMO TORNEIRA
BIOPRESS
CR - CPD.05327

CILINDRO TORNEIRA BIOPRESS * *
CPD.05328

ECONOMIZADOR 6L/MIN
CPD.06182

* Para retirar o mecanismo utilize chave
de boca 32mm ou alicate bomba d'água.

* * Para soltar o cilindro do castelo
utilize chave de fenda 1/8"

AREJADOR T2 EMBUTIDO
CPD.04878

3

chave Allen 3/32"
(inclusa)

FLANGE AV
CPD.06276

FLANGE 1/2"
CPD.05055

TORNEIRA DE PAREDE

Ref. 1182

* MECANISMO TORNEIRA
BIOPRESS
CR - CPD.05327

CILINDRO TORNEIRA BIOPRESS * *
CPD.05328

ECONOMIZADOR 6L/MIN
CPD.06182

CANOPLA SELECTA
CR - CPD.01094

Obs.: Canopla atual
sem borracha

AREJADOR T2 EMBUTIDO
CPD.04878



Recursos especiais para casos específicos procure nas páginas de detalhamento dos reparos.

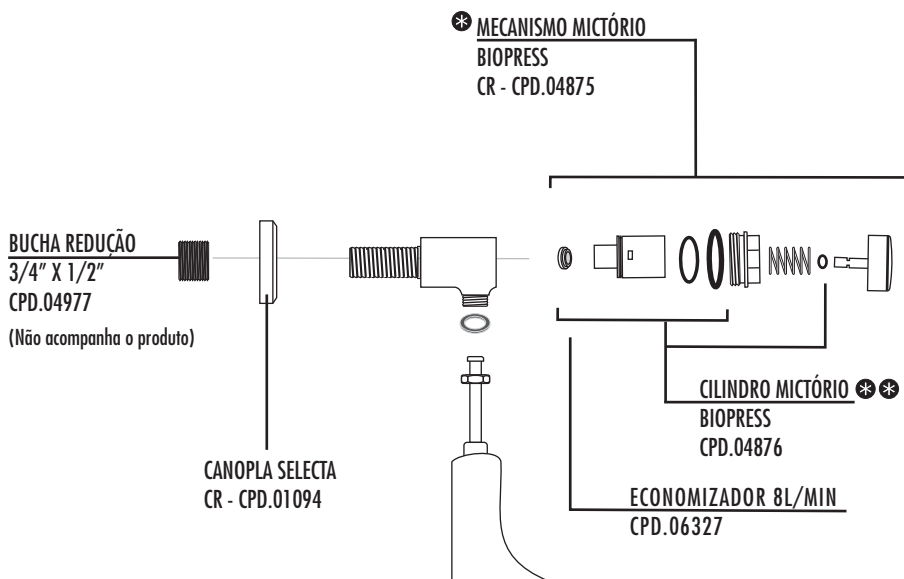

* Para retirar o mecanismo utilize chave de boca 32mm ou alicate bomba d'água.

* * Para soltar o cilindro do castelo utilize chave de fenda 1/8"

TORNEIRA DE PAREDE AV
Ref. 1182

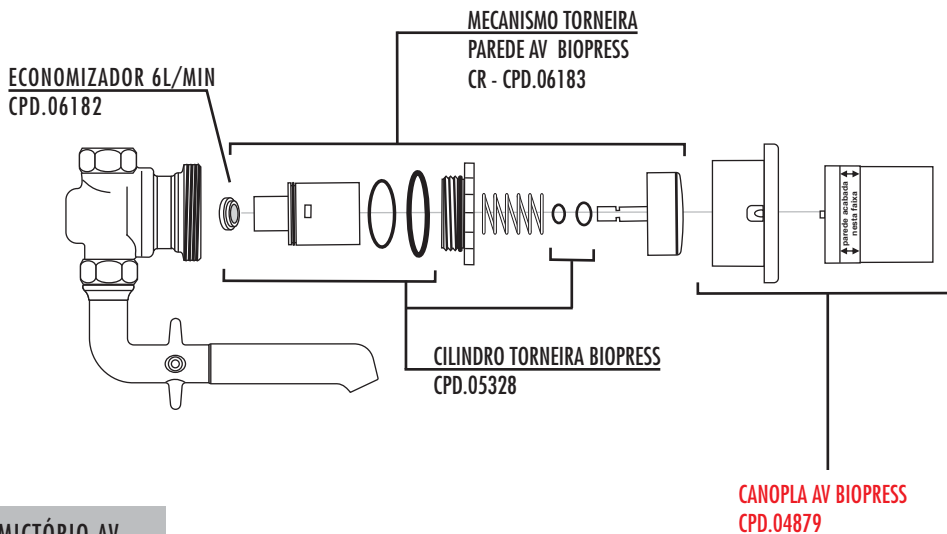

MICTÓRIO AV
Ref. 1181

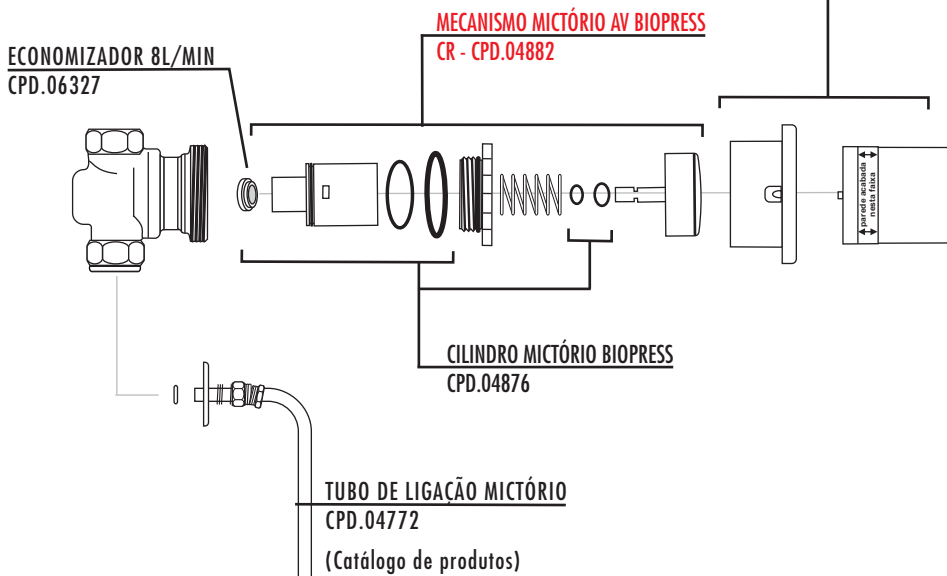

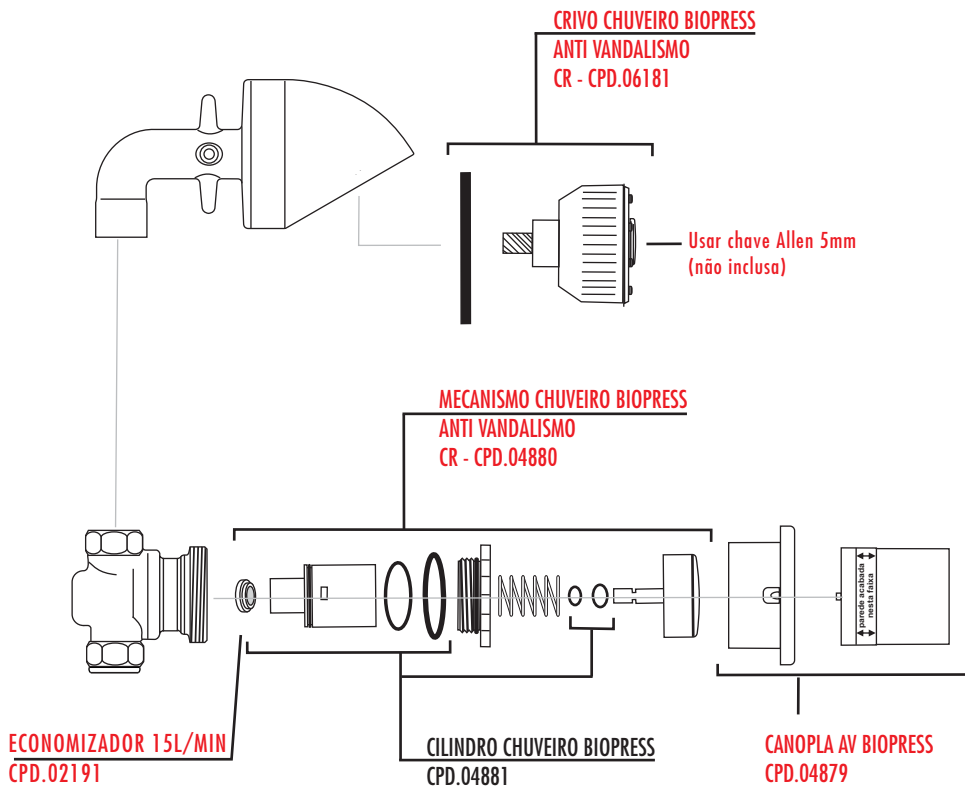

DETALHAMENTO DE REPAROS

*1 AREJADOR T2 MACHO SPRAY 1,8 L/MIN

CR - CPD.06313

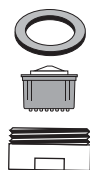
*2 AREJADOR T2 MACHO AV SPRAY 1,8 L/MIN

CR - CPD.06324

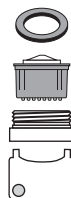
*3 AREJADOR EMBUTIDO SPRAY M24 1,8 L/MIN

CPD.06323

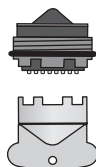

REGULADORES DE VAZÃO

Página 10.01

AREJADORES

Página 10.02

AREJADORES SPRAY

Página 10.04

AREJADORES EMBUTIDOS

Página 10.05

VÁLVULA DE ESCOAMENTO

Página 10.06

BICA DESVIADORA

Página 10.07

SIFÃO

Página 10.08

MICTÓRIO ACQUACLEAN

Página 10.09

REGULADOR DE VAZÃO 12L/MIN

CR - CPD.01644

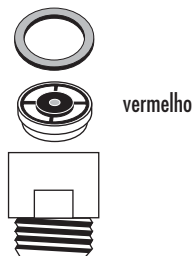

REGULADOR DE VAZÃO 15L/MIN

CR - CPD.02175

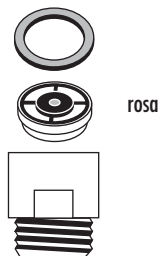

REGULADOR DE VAZÃO 18L/MIN

CR - CPD.04040

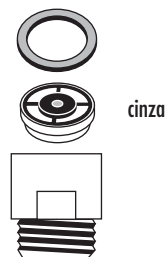

ECONOMIZADORES



- 6 litros - CPD.06182 (preto)
 - * 8 litros - CPD.06327 (branco)
 - * 12 litros - CPD.04877 (vermelho)
 - * 15 litros - CPD.02191 (rosa)
 - * 18 litros - CPD.04048 (cinza)
- * Guarnição de ½ inclusa.

FORA DE LINHA

SEDE M14 VAZÃO REDUZIDA



CPD.03989

FORA DE LINHA

SEDE M12 VAZÃO REDUZIDA



CPD.05320

FORA DE LINHA

OBS.: Substitui sede M14 e reduz a vazão de água.

Usar chave Allen 3/8"
(não inclusa)

OBS.: Substitui sede M12 e reduz a vazão de água.

Usar chave Allen 7mm
(não inclusa)

Os reguladores de vazão e economizadores representados nesta página se adaptam a todos os chuveiros FABRIMAR.

AREJADORES COM ROSCA MACHO

AREJADOR T1 MACHO

CR - CPD.03085

MIOLO AREJADOR T1
CPD.06186

 FORA DE LINHA



AREJADOR T2 MACHO

CR - CPD.07101

MIOLO AREJADOR T2
CPD.06187

 FORA DE LINHA



TRANQUILIZADOR T2 MACHO

CR - CPD.04991

 FORA DE LINHA

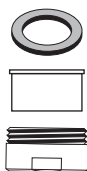

AREJADOR T2 MACHO ARTICULÁVEL

CR - CPD.00121

MIOLO AREJADOR T2
CPD.06187

 FORA DE LINHA



AREJADOR T2 MACHO ARTICULÁVEL CURTO

CR - CPD.06447

 FORA DE LINHA



MIOLO AREJADOR T2
CPD.06187

 FORA DE LINHA

Obs.: Para rosquear a articulação, retire o arejador e use chave allen.

AREJADOR T2 MACHO VAZÃO CONSTANTE 6 L/MIN.

CR - CPD.01661

MIOLO AREJADOR T2
VAZÃO CONSTANTE 6 L/MIN.
CPD.06189

Obs.: Vazão constante de 6 l/min para pressões acima de 10 mca.

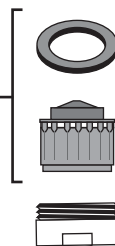

AREJADOR T2 MACHO ANTI-VANDALISMO

CR - CPD.01429

 FORA DE LINHA

MIOLO
AREJADOR T2
CPD.06187

MIOLO AREJADOR T2
VAZÃO CONSTANTE 6L/MIN.
CPD.06189

Utilizado em locais de baixa pressão

 Vazão constante de 6 l/min para pressão acima de 10 mca

 FORA DE LINHA

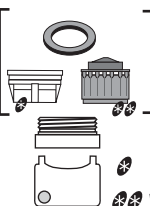

AREJADOR CURTO T2 MACHO

CR - CPD.07225

 FORA DE LINHA

MIOLO AREJADOR T2
CPD.06187

 FORA DE LINHA

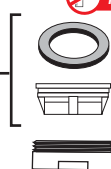

AREJADORES COM ROSCA FÊMEA

AREJADOR TO FÊMEA

CR - CPD.04345

MIOLO AREJADOR TO
CPD.06185

AREJADOR TO ARTICULÁVEL

CR - CPD.04347

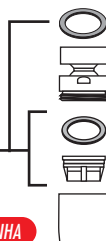
MIOLO
AREJADOR TO
CPD.06185

AREJADOR T1 FÊMEA

CR - CPD.02712

MIOLO
AREJADOR T1
CPD.06186Obs.: Utilizado nas linhas Loft e
Loft Design e torneiras Ref.:1159

AREJADOR T2 FÊMEA

CR - CPD.07116

MIOLO
AREJADOR T2
CPD.06187

AREJADOR T2 FÊMEA ARTICULÁVEL

CR - CPD.07125

MIOLO
AREJADOR T2
CPD.06187Obs.: Para rosquear a articulação,
retire o arejador e use chave allen

AREJADOR T2 FÊMEA DE VAZÃO CONSTANTE 6 L/MIN

CR - CPD.02632

MIOLO AREJADOR T2
VAZÃO CONSTANTE
6L/min
CPD.06189

AREJADOR T2 FÊMEA COM EXTENSÃO

CR - CPD.07156

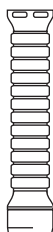

AREJADOR T2 MACHO SPRAY

CR - CPD.06313

MIOLO AREJADOR
T2 SPRAY
CPD.06317

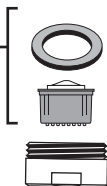

AREJADOR T2 FÊMEA SPRAY

CR - CPD.06312

MIOLO AREJADOR
T2 SPRAY
CPD.06317

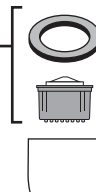

AREJADOR T2 MACHO AV SPRAY

CR - CPD.06324



MIOLO AREJADOR
T2 SPRAY
CPD.06317

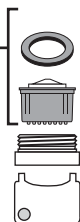

AREJADOR EMBUTIDO SPRAY M18,5

CPD.06321

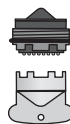

AREJADOR EMBUTIDO SPRAY M24

CPD.06323

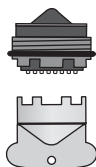

AREJADOR EMBUTIDO M18,5

CPD.05333

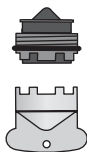
**AREJADOR EMBUTIDO M18,5**

CPD.06409

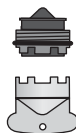
**AREJADOR EMBUTIDO RETANGULAR 32 x 8**

CPD.06110



Usar chave Allen 1,5mm
(inclusa)

AREJADOR EMBUTIDO RETANGULAR 28 x 7

CPD.07316



Usar chave Allen 1,5mm
(inclusa)

AREJADOR T2 EMBUTIDO

CPD.04878

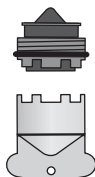

VÁLVULA DE ESCOAMENTO UNIVERSAL

plug
plástico



plug
metálico

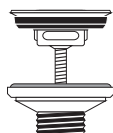

CR - CPD.02571
CR/CR- CPD.02785*

(Tabela de produtos)

* válvulas que vêm com
plug com capa metálica.

PLUG VÁLVULA DE ESCOAMENTO UNIVERSAL

CR - CPD.02789

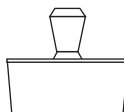

Fora de linha

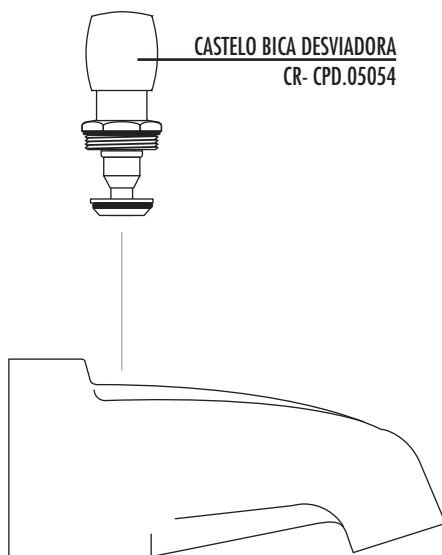

Lavatório - 1"

Cozinha - 1 1/2" / Tanque - 1 1/4"

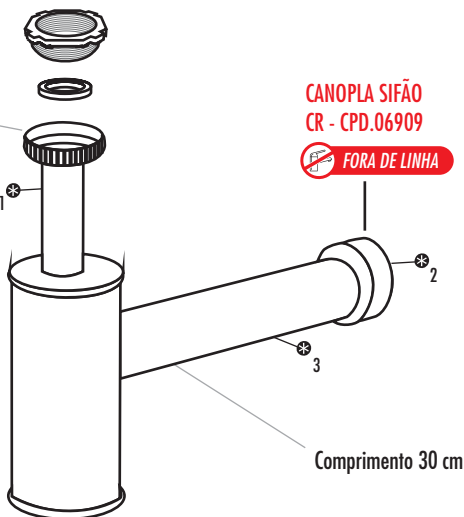

Detalhamento de Reparos

1 PROLONGADOR SIFÃO

(Tabela de produtos)

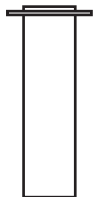

- LAVATÓRIO 20 CM INOX - CPD.06252
- LAVATÓRIO 30 CM INOX - CPD.06254
- COZINHA 20 CM - CPD.06224
- COZINHA 30 CM - CPD.06225
- TANQUE 20 CM - CPD.06227
- TANQUE 30 CM - CPD.06228
- TANQUE / COZINHA 20 CM INOX - CPD.07241
- TANQUE / COZINHA 30 CM INOX - CPD.07242

FORA DE LINHA

2 BUCHA REDUÇÃO TUBO SAÍDA SIFÃO 50 X 40mm

CPD.06223

(Tabela de produtos)



3 TUBO SAÍDA SIFÃO

- LATÃO 30cm - CR - CPD.06428
- LATÃO 40cm - CR - CPD.06429
- INOX 30cm - CPD.07310
- INOX 40cm - CPD.07245

FORA DE LINHA

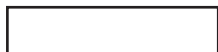

4 VEDAÇÃO SIFÃO

- 1" LAVATÓRIO - CPD.06905
- 1 1/4" TANQUE e 1 1/2" COZINHA - CPD.06908

FORA DE LINHA



Fora de linha

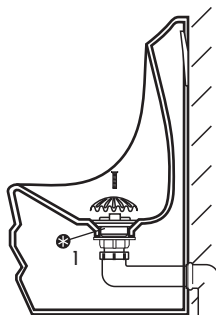

Detalhamento de Reparos

* 1 REFIL MICTÓRIO ACQUAFREE

CPD.06912

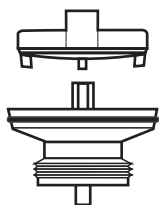

<u>IMAGE</u>	Página 11.01
<u>CASUAL</u>	Página 11.02
<u>SAGA</u>	Página 11.03
<u>INCLASSIC</u>	Página 11.04
<u>DEMAIS LINHAS</u>	Página 11.05
<u>UNIVERSAL/OGGI E DOMANI</u>	Página 11.06
<u>FLAT</u>	Página 11.07

Fora de linha

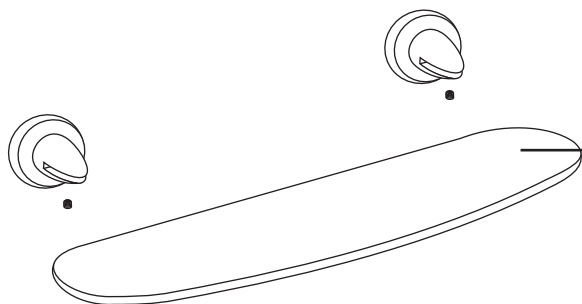

VIDRO PRATEIRA IMAGE
CPD.04015

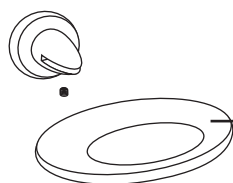

VIDRO SABONETEIRA
IMAGE
CPD.04024

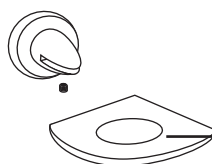

VIDRO SABONETEIRA
CANTO IMAGE
CPD.05449

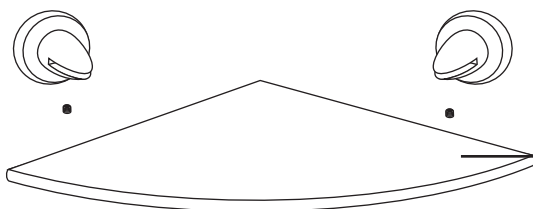

VIDRO PRATEIRA
CANTO IMAGE
CPD.04019



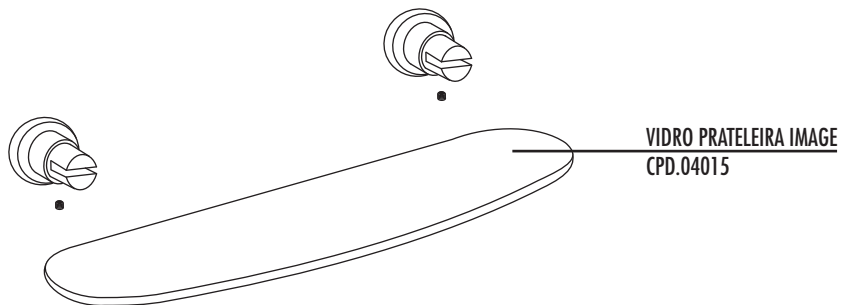

 FORA DE LINHA

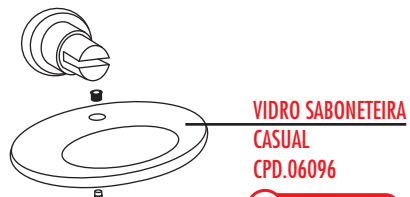

 FORA DE LINHA

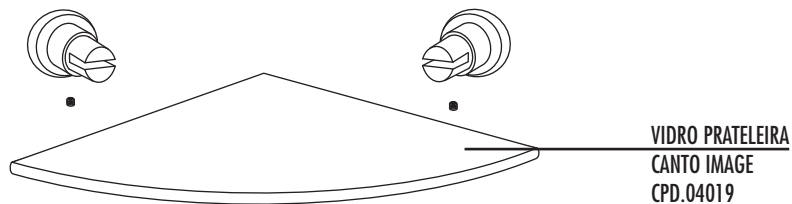

Fora de linha

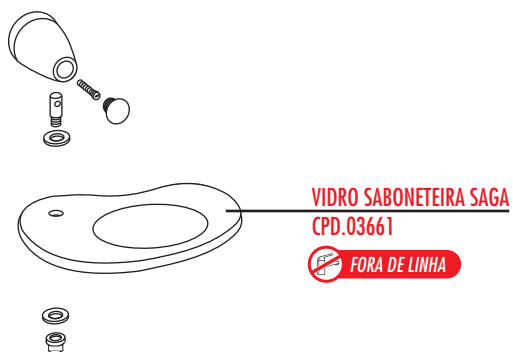
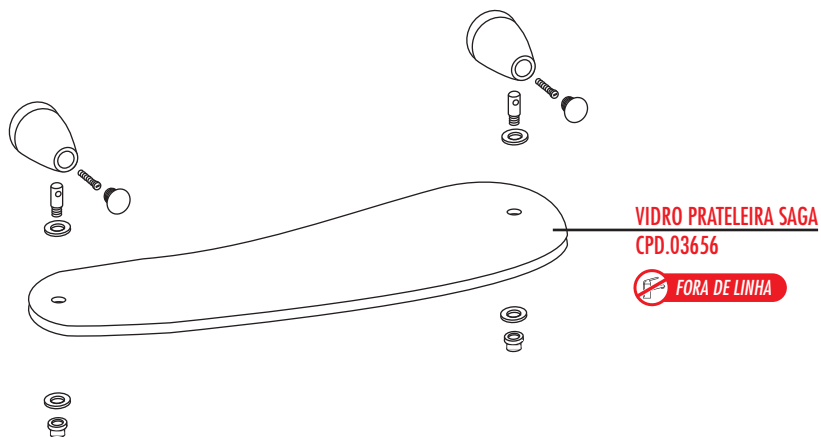

Fora de linha

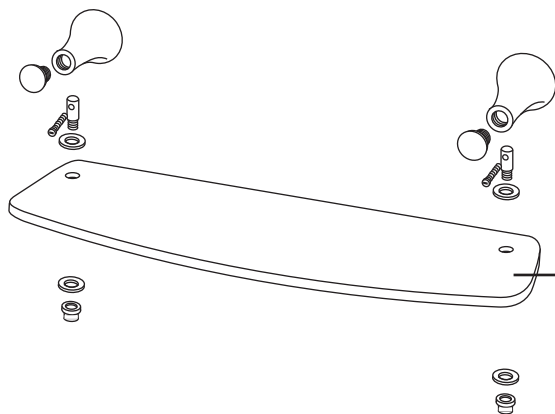

VIDRO PRATELEIRA INNOVARE
CPD.03666

 FORA DE LINHA

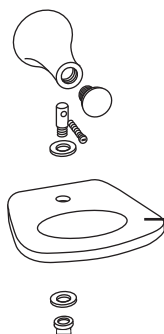

VIDRO SABONETEIRA INNOVARE
CPD.03667

 FORA DE LINHA

Fora de linha

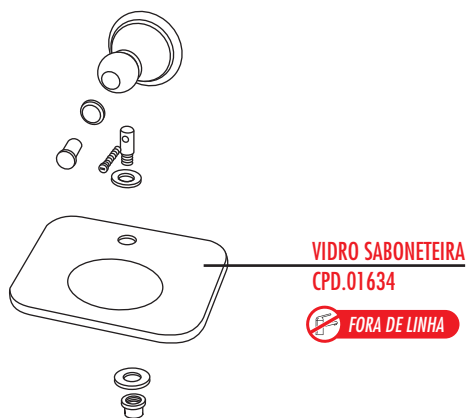
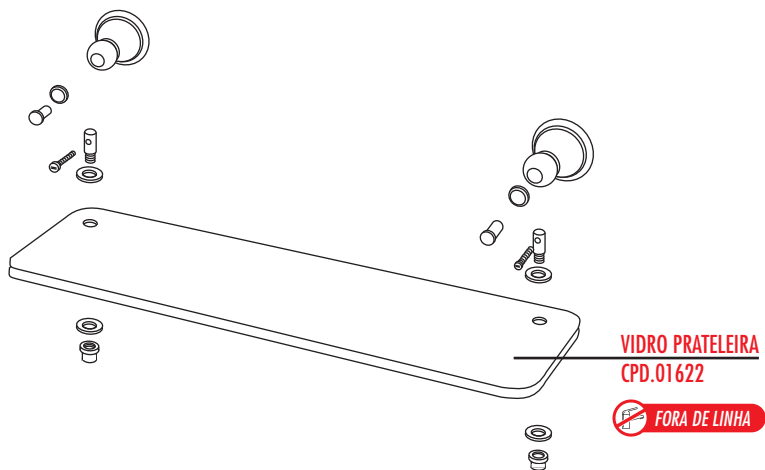

SUPORE ACESSÓRIOS
UNIVERSAL
CPD.01505



CANOPLA ACESSÓRIOS
UNIVERSAL
CR - CPD.01534

Obs.: Somente os
acessórios Universal
possuem canopla.



CALOTA ACESSÓRIOS
UNIVERSAL
CR - CPD.01506

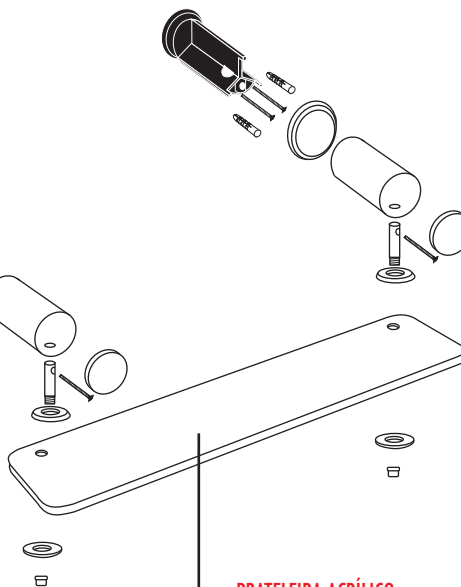

PRATELEIRA ACRÍLICO
ACESSÓRIOS UNIVERSAL
CPD.01503

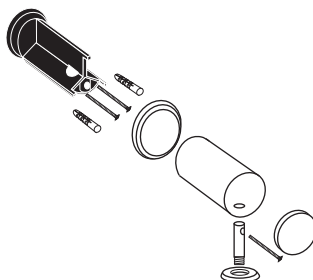

SABONETEIRA ACRÍLICO
ACESSÓRIOS UNIVERSAL
CPD.01504



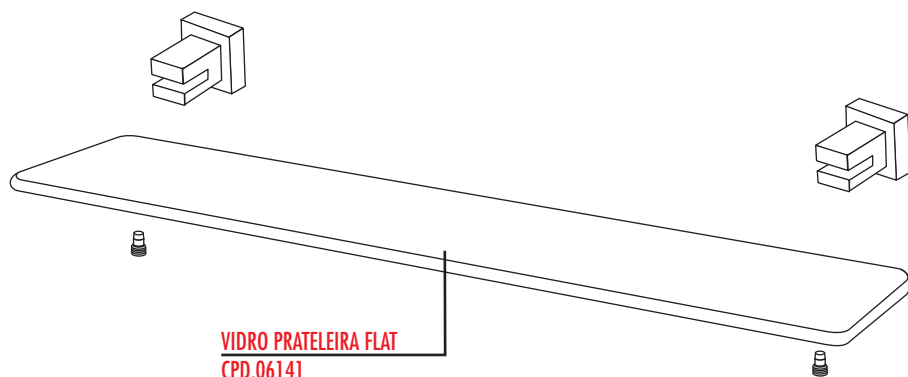

VIDRO PRATELEIRA FLAT
CPD.06141

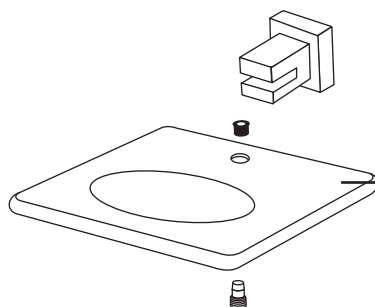

VIDRO SABONETEIRA FLAT
CPD.06142



A Fabrimar se reserva o direito de alterar as características gerais, técnicas e estéticas de seus produtos sem prévio aviso.

Catálogo disponível também em versão eletrônica no endereço:
<http://www.fabrimar.com.br/catalogos.asp>

Obs.: A versão eletrônica é sempre mais atualizada.

FABRIMAR



SAC 0800 022-1362



www.fabrimar.com.br



facebook.com/metais.fabrimar

55902298

RIO DE JANEIRO

Rod. Presidente Dutra, 1362, Pavuna
Rio de Janeiro - RJ - CEP.: 21535-502
Tel.: (021) 3088 2200 Fax: (021) 3088 2233
dat@fabrimar.com.br